

Panasonic®

**Building Passion,
Building Solutions.**
Panasonic Air Conditioning Systems

We face a time in which "quality air" differentiates business. It's a time for Panasonic to fully display its strengths. Our ability to assemble and build superior systems isn't just due to the rich resources we have as a comprehensive electronics manufacturer, but also to Panasonic's 100 years of tradition, where each person thinks and acts on their own initiative while working in a team to reach further heights. We do not compromise. Each of our independent selves is a one stop solution. We face our customers' challenges together with our customers and do all that we can to build effective systems. As a true partner for our customers, we strive to always be at the forefront of business.

- Please read the Installation Instructions carefully before installing the unit, and the Operating Instructions before using it.
- Specifications are subject to change without prior notice.
- The contents of this catalogue are accurate as of March 2021.
- Due to printing considerations, actual colours may vary slightly from those shown.
- All graphics are provided solely for the purpose of illustrating a point.



Do not add or replace refrigerant other than the specified type. Manufacturer is not responsible for damage or deterioration in safety due to usage of other refrigerant.

Authorised Dealer

OCAU_R32 PAC_CAT_2020_V3

Panasonic Australia Pty. Limited.

Address: 1 Innovation Road, Macquarie Park, NSW 2113
ACN 001 592 187 ABN 83 001 592 187

aircon.panasonic.com.au

R32 RESIDENTIAL & LIGHT COMMERCIAL AIR CONDITIONING 2020 / 2021

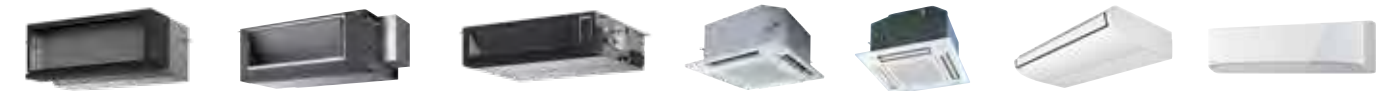

nanoe™

R32
REFRIGERANT

A Better Life, A Better World

QUALITY AIR FOR LIFE

The new Panasonic NX series

The next generation is now

The new CONEX remote controller (CZ-RTC6BLW) multiplies the benefits of a standard nanoe™ X installation, letting you create clean, healthy air in your living spaces 24 hours a day, anytime, anywhere. Choose your quality of air - a new era in air conditioning solutions is here.

CONTENTS

Product Line-up	4 - 5
Better Air Quality	6 - 11
CONEX	12 - 15
Ducted	16 - 19
Outdoor Unit	20 - 29

Indoor Unit	
High Static Pressure Ducted	30 - 33
High Static Pressure Splittable Ducted	34 - 35
High Static Pressure Adaptive Ducted	36 - 39
Ultra Slim Ducted	40 - 41
4-WAY Cassette	42 - 45
4-WAY Mini Cassette	46 - 47
Under Ceiling	48 - 51
Wall Mounted	52 - 53
Floor Console	54 - 55
Dimensions	56 - 61
Smart Control Management Solutions	
Panasonic Comfort Cloud	64 - 65
Home Automation	66 - 67
PAC Smart Connectivity+	68 - 75
Panasonic AC Smart Cloud	76 - 77
Controllers	78 - 87

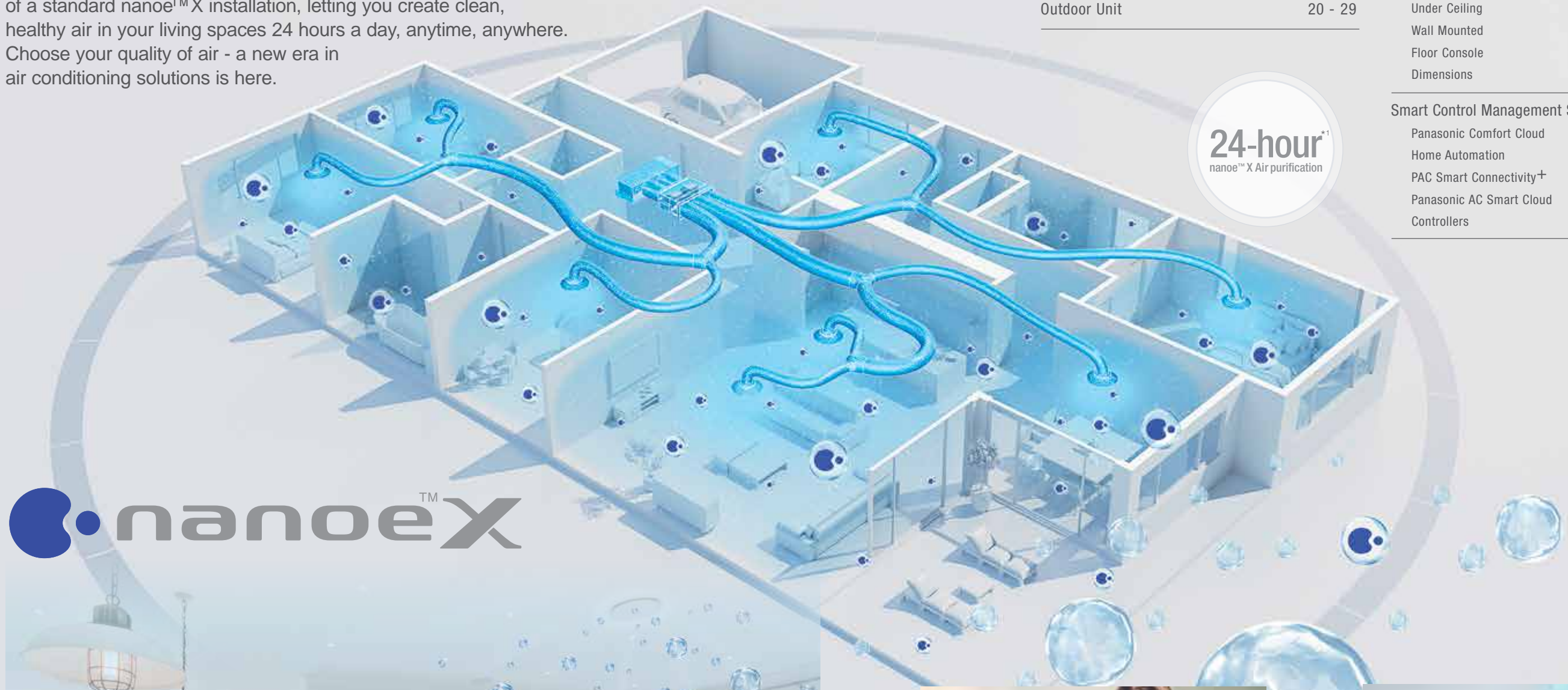

24-hour nanoe™ X Air purification

Unlike the general filters found in an air purifier, nanoe™ X achieves a powerful inhibiting effect on not only airborne, but also adhered bacteria and viruses.

P. 6 - 11



P. 12 - 15

Make comfort more accessible with CONEX

CONEX goes beyond simple remote control to combine sophistication with simplicity, offering IoT integration that connects directly to a variety of apps for next-generation solutions.



P. 16 - 17

Maximum versatility adaptive ducted unit

Designed to deliver flexibility, performance, and comfort, Panasonic introduces an industry-leading horizontal/vertical design featuring powerful 150Pa static pressure in a compact unit.

Note: PF3 range only.

Product Line-up

		Cooling Capacity												
		2.5 kW	3.6 kW	5.0 kW	6.0 kW	7.1 kW	10.0 kW	12.5 kW	14.0 kW	16.0 kW	18.0 kW	20.0 kW	22.4 kW	
Indoor Unit	Ducted	NX Series High Static Ducted High Static Pressure Model Page 30-33 for 6.0kW to 16.0kW nanoeX Generator Mark 2 ECONAVI ready				S-60PE3R	S-71PE3R	S-100PE3R	S-125PE3R	S-140PE3R	S-160PE3R			
		Splittable Ducted High Static Pressure Model Page 34-35 for 18kW - 22.4kW										S-180PE3R5B	S-200PE3R5B	S-224PE3R5B
		NX Series Adaptive Ducted High Static Pressure Model Page 36-39 nanoeX Generator Mark 2 ECONAVI ready		S-3650PF3E	S-3650PF3E	S-6071PF3E	S-6071PF3E	S-1014PF3E	S-1014PF3E	S-1014PF3E				
		Ultra Slim Ducted Page 40-41	CS-Z25UD3RAW	CS-Z35UD3RAW	CS-Z50UD3RAW	CS-Z60UD3RAW								
	Cassette	NX Series 4-WAY Cassette * Panel is provided as an option (CZ-KPU3H/CZ-KPU3A) Page 42-45 nanoeX Generator Mark 1 ECONAVI ready				S-6071PU3E	S-6071PU3E	S-1014PU3E	S-1014PU3E	S-1014PU3E				
		Mini Cassette Page 46-47	CS-Z25UB4RAW	CS-Z35UB4RAW	CS-Z50UB4RAW	CS-Z60UB4RAW								
Under Ceiling	NX Series Page 48-51 nanoeX Generator Mark 2 ECONAVI ready				S-6071PT3E	S-6071PT3E	S-1014PT3E	S-1014PT3E	S-1014PT3E					
Wall Mounted	NX Series Page 52-53 nanoeX Generator Mark 2 ECONAVI ready						S-100PK3R							
Floor Console	Page 54-55 nanoeX Generator Mark 1	CS-Z25UFRAW	CS-Z35UFRAW	CS-Z50UFRAW										
Outdoor Unit	NX Series* <small>*1 Except 16kW onwards</small>	R32 Deluxe Model Page 20-29 R32 REFRIGERANT DRED ready				U-71PZH3R5	U-100PZH3R5 U-100PZH3R8*2	U-125PZH3R5 U-125PZH3R8*2	U-140PZH3R5 U-140PZH3R8*2	U-160PZH2R5 U-160PZH2R8*2	U-180PZH2R8*2	U-200PZH2R8*2	U-224PZH2R8*2	
		R32 Compact Model Page 20-29 R32 REFRIGERANT DRED ready		U-36PZ3R5	U-50PZ3R5	U-60PZ3R5	U-71PZ3R5	U-100PZ3R5 U-100PZ3R8*2	U-125PZ3R5 U-125PZ3R8*2	U-140PZ3R5 U-140PZ3R8*2				*2 3 phase
	R32 Model	R32 REFRIGERANT DRED ready	CU-Z25UBRA	CU-Z35UBRA	CU-Z50UBRA	CU-Z60UBRA								

24-hour nanoe™ X Air purification*1

While the general filters in air purifiers are effective against airborne bacteria and viruses, nanoe™ X also works to inhibit longer-living, adhered bacteria and viruses. As well as this, the CONEX remote control (CZ-RTC6BLW) gives you access to your air conditioner anywhere, anytime, so you can turn nanoe™ X on even while you're out and enjoy 24-hour quality air in your home.



*1 The nanoe™ X mode can be run independently from cooling or heating mode, and needs to be on for the 24 hour air purification to function.
 *2 <https://www.businessinsider.com/coronavirus-lifespan-on-surfaces-graphic-2020-3>



nanoe™ X works even in larger space*3

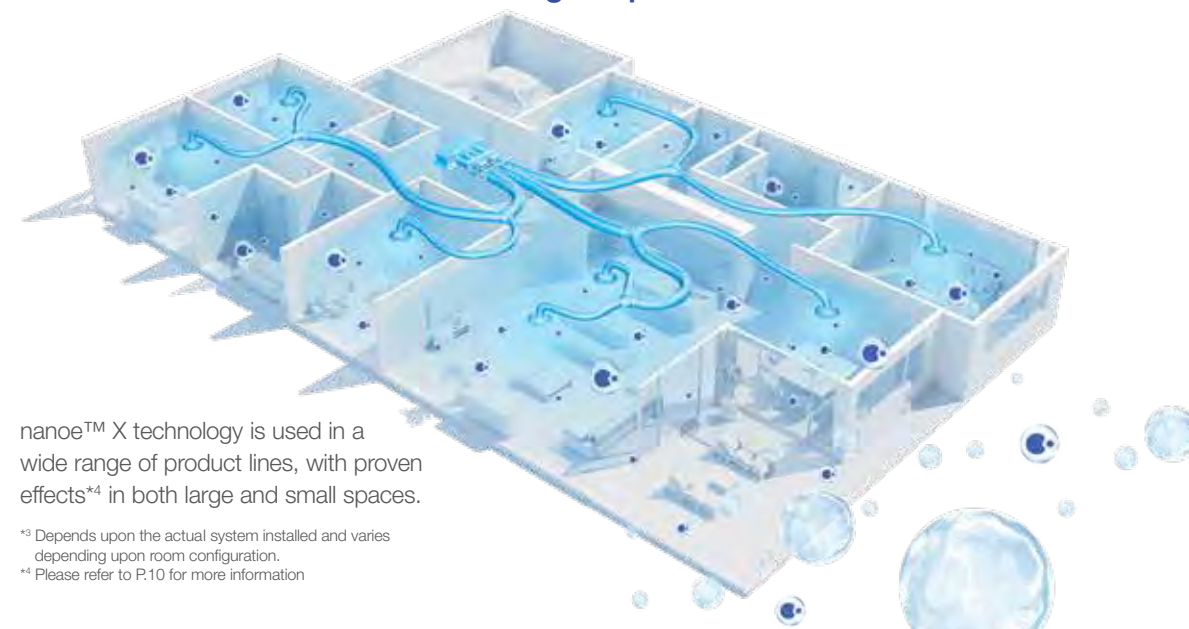

nanoe™ X technology is used in a wide range of product lines, with proven effects*4 in both large and small spaces.

*3 Depends upon the actual system installed and varies depending upon room configuration.
 *4 Please refer to P.10 for more information

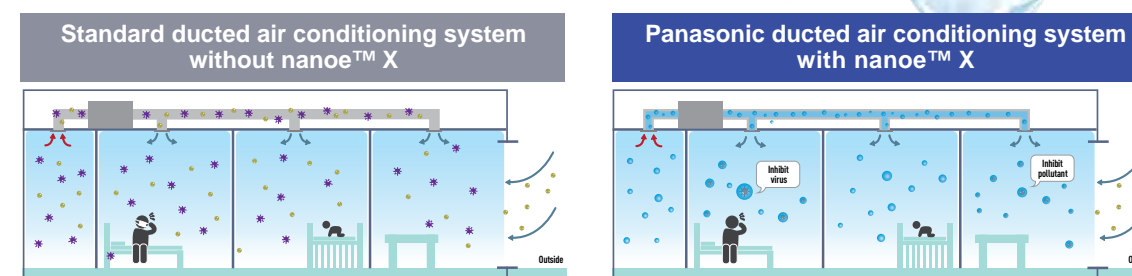

Viruses or bacteria carried by a room's occupants, as well as external pollutants from open windows, may actually be circulated around a home by conventional air conditioning.

With a nanoe™ X-equipped ducted unit, it's not only viruses and bacteria that are circulated, the ducted unit itself produces a massive 9.6 trillion hydroxyl radicals per second which are delivered to rooms throughout the house, inhibiting viruses and bacteria.

How does nanoe™ X technology work against viruses?

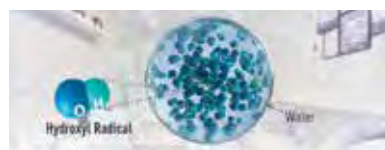

1 Huge Quantity

9.6 trillion hydroxyl radicals are generated per second, inhibiting bacteria and adhered viruses. (nanoe X Generator Mark 1 generates 4.8 trillion hydroxyl radicals/ sec)

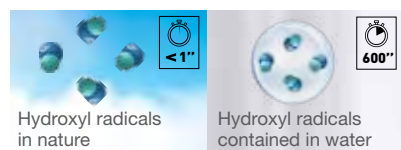

2 Longer lifespan

By creating hydroxyl radicals contained in water, nanoe™ X technology, increasing hydroxyl radicals lifetime so that nanoe™ X can spread over long distances.
<https://www.panasonic.com/global/consumer/clean/hydroxyl/technology.html>



3 Actively fill the room

Going beyond standard filter technology, hydroxyl radicals circulate throughout rooms inhibiting both airborne and adhered bacteria and viruses.

Effective on Adhered Pollutants

nanoe™ X penetrates deep into fabrics and deodorises, inhibits bacteria, viruses, mould, allergens, pollen and hazardous substances.

nanoe™ X extensively spread out through the room to inhibit adhered pollutants adhering to surfaces, while air filters only collect airborne dust but adhered substances.

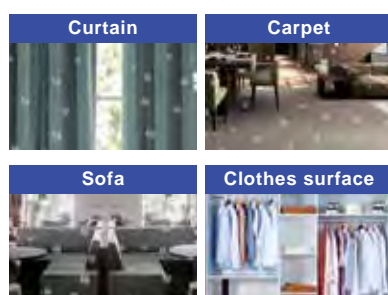
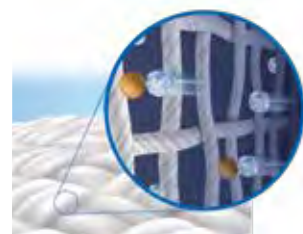

24hr nanoe™ X comfort, wherever you are, anywhere, anytime

Get 24 hr Quality Air for you and your loved ones by turning nanoe™ X on using Panasonic Comfort Cloud*5 even when you're out, and enjoying clean air when you're at home. nanoe™ X functions in both cooling and heating modes and is maintenance-free, helping you keep your costs down with cleaner air.

**Clean air independently when you are away
(Fan Mode + nanoe™ X ON)**

**Comfort and Clean air when you are at home
(Cooling or Heating Mode + nanoe™ X ON)**

Only at 70W/Hour*6
 Low energy consumption with fan mode 70W per hour for a single unit.

Maintenance-Free
 No maintenance required for nanoe™ X generator device.

24-hour nanoe™ X Air Purification

*5 Wireless LAN Remote Control for Internet Connection required optional network adaptor. Indoor temperature display and some special function are not available through the App for some models.
 *6 Energy consumption may vary depending on models and the external static pressure.

Bringing nature's balance indoors

nanoe™ X technology with the benefits of hydroxyl radicals

The well-being benefits of nature are well known - but do you know the power of hydroxyl radicals?

Abundant in nature, hydroxyl radicals (also known as OH radicals) inhibit pollutants, viruses and bacteria to clean and deodorise. nanoe™ X technology can bring these incredible benefits indoors so that hard surfaces, soft furnishings, and the indoor environment can be a clean and pleasant place to be, whether at home, at work, visiting hotels, shops or restaurants.

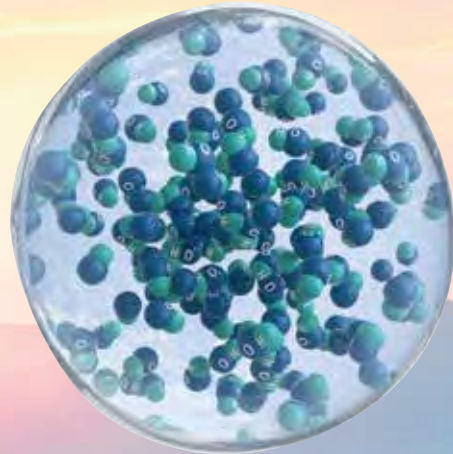

Hydroxyl radicals contained in water

A naturally occurring process

Hydroxyl radicals are unstable molecules looking to react with other elements like hydrogen molecules of pollutants. Thanks to this reaction, hydroxyl radicals inhibit the growth of pollutants such as viruses, bacteria, moulds, and odours, breaking them down and neutralising the unpleasant effects. This naturally occurring process has major benefits to improve indoor air quality.

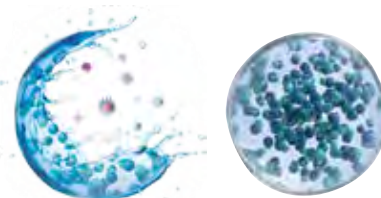

Bringing nature's balance indoors nanoe™ X technology with the benefits of hydroxyl radicals

nanoe™ X technology with the benefits of hydroxyl radicals

Panasonic's nanoe™ X technology takes a step further and brings nature's detergent - hydroxyl radicals - indoors to help create an ideal environment.

By creating hydroxyl radicals contained in water, nanoe™ X technology significantly boosts their effectiveness, increasing hydroxyl radicals lifetime from less than a second in nature, to more than 600 seconds – 10 minutes.

<https://www.panasonic.com/global/consumer/clean/hydroxyl/technology.html>



Hydroxyl radicals in nature



Hydroxyl radicals contained in water - nanoe™ X



Effectiveness of nanoe™ X

nanoe™ X deodorises, inhibits bacteria & viruses, mould, allergens, pollen and hazardous substances, as well as moisturising the whole room for smoother skin and hair.

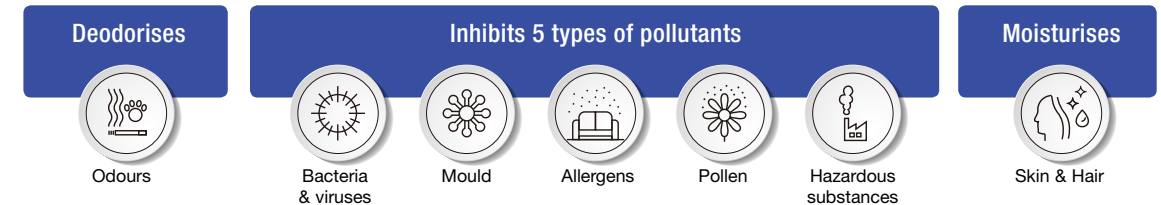

For further details and validation data, please refer to the following website: https://aircon.panasonic.com/introducing/whats_nanoex/nanoex.html



Thanks to the nanoe™ X properties, several types of pollutants can be inhibited.



nanoe™ X reliably reaches pollutants.

Hydroxyl radicals transform pollutants' proteins.

Pollutants activity is inhibited.

The evolution of nanoe™ X technology

Through continuous research and development, nanoe™ X is the latest generation of Panasonic nanoe technology.

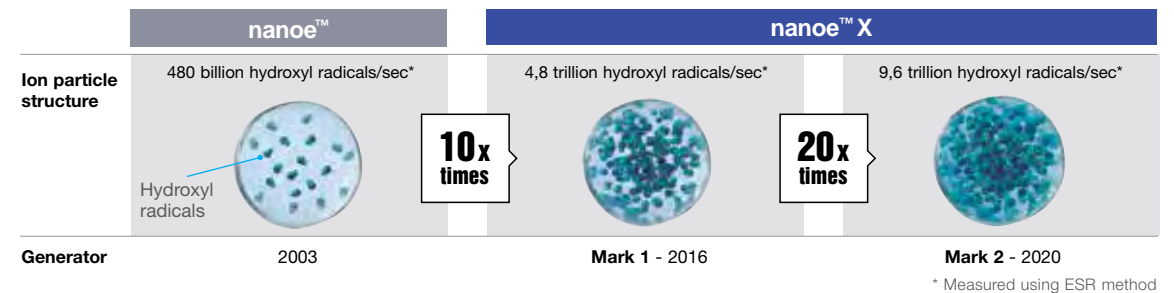

Sensitive Choice (National Asthma Council Australia) Approved

Sensitive Choice is a community service program that aims to educate people on the importance of managing asthma and allergies. Developed by the National Asthma Council Australia in 2006, the program also encourages companies to produce products and services that are more asthma and allergy aware. Panasonic and Sensitive Choice have partnered to introduce nanoe™ X to the Australian market.





Verification tests for nanoe™ X effects in large spaces



Hazardous substances

The nanoe™ X inhibited hexadecane, a chemical contained in PM2.5 (267m²)

3rd party

A third-party certification organization SIRIM Berhad (SIRIM)^{*1}, conducted the performance experiment using a 4-Way Cassette equipped with a nanoe™ X device to inhibit hexadecane^{*2}, a chemical contained in PM2.5.

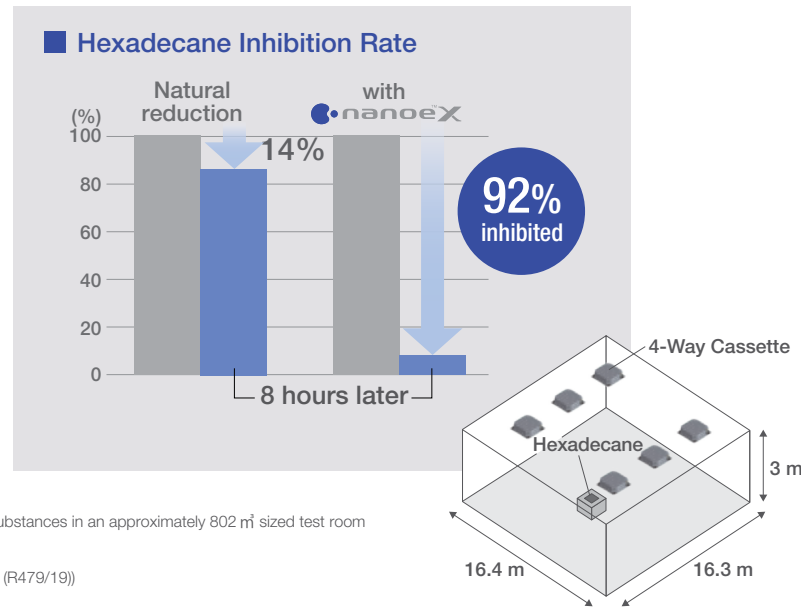
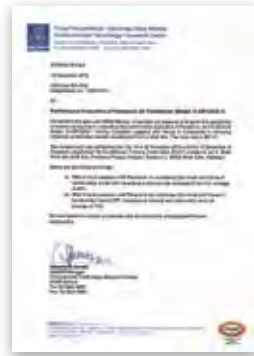

^{*1} SIRIM is a premier industrial research and technology organisation in Malaysia, a wholly-owned company of the Malaysian Government under the Ministry of International Trade and Industry (MITI).
^{*2} Hexadecane is a hazardous substance contained in gasoline and diesel exhaust gas.

Testing method: Measured the amount of attached organic substances in an approximately 802 m² sized test room
 Inhibition method: nanoe X Generator Mark 1 released
 Test substance: Hexadecane
 Test result: Broken down 92% in 8 hours (ETRC257/16/1402 (R479/19))



odours

The nanoe™ X reduced the odours adhering to fibers such as curtains and carpets (139m²)

3rd party

Cigarette smoke odour

Results

Compared to natural reduction, the nanoe™ X blast reduced the odour intensity by more than approximately 0.7 after two hours.

Testing organization

KAKEN TEST CENTER General Incorporated Foundation in Japan, international testing institute.

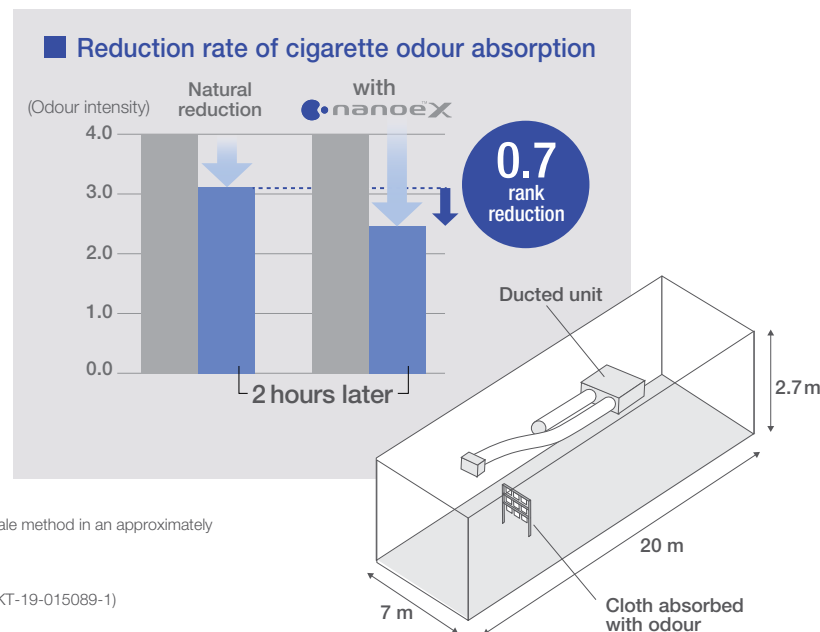

Testing method: Verified using the six-level odour intensity scale method in an approximately 378m² sized test room
 Inhibition method: nanoe X Generator Mark 2 released
 Test substance: Surface-attached cigarette smoke odour
 Test result: Odour intensity reduced by 0.7 levels in 2 hours (KT-19-015089-1)

The effects of nanoe™ X are recognised by experts in each field



Professor Masafumi Mukamoto
 Osaka Prefecture University
 Veterinary Infectious Disease Studies

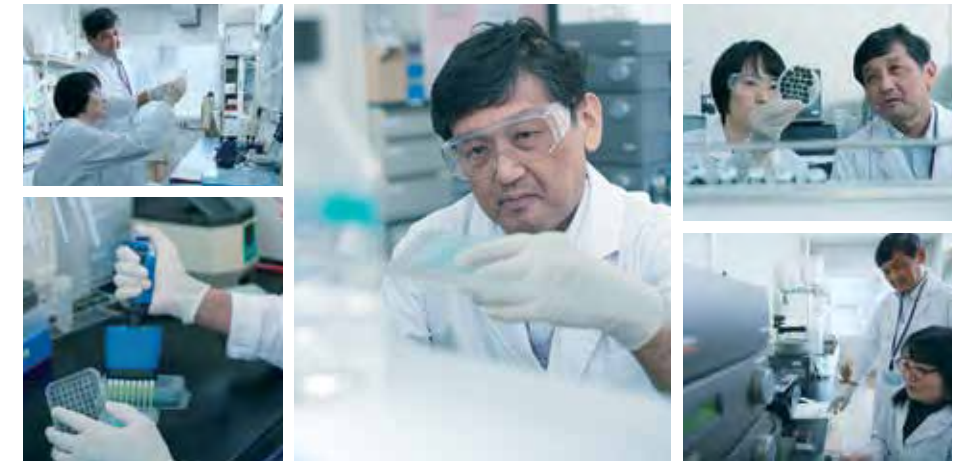

Various types of moulds enter houses along with people and air. Even if preventive action is taken in our everyday lives, it is often very difficult to inhibit the growth of mould, especially in humid environments. With nanoe™ X, we have experimental results^{*3*} that show we can inhibit the growth of the types of mould and bacteria commonly found in various places in the house.

Hope for the creation of more comfortable spaces for those who have problems with asthma or atopic dermatitis



Professor Masahiro Sakaguchi
 Azabu University
 School of Veterinary Medicine
 Laboratory of Veterinary Microbiology I

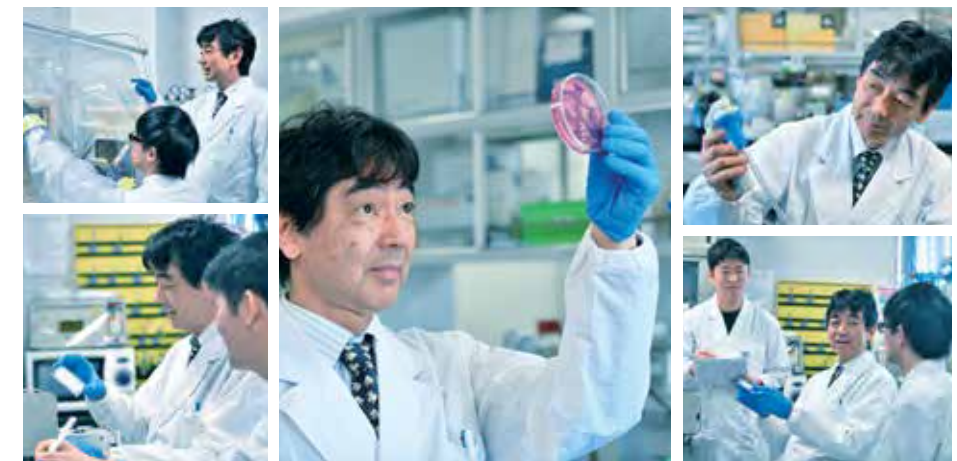

We have experimental results that show nanoe™ X is capable of inhibiting allergens, such as pollen and dust mites. It is important to take precautions against the allergens that we inadvertently inhale in our daily lives. As nanoe™ X is effective in inhibiting invisible allergens, we can expect it will create a cleaner environment. As the safety of nanoe™ X has also been verified, nanoe™ X gives peace of mind to families with small children.

^{*3} Experimental results show that nanoe™ X is effective in inhibiting the growth of the following types of mould and bacteria commonly found in homes:
 Mould: Trichophyton, Cladosporium, Malassezia furfur, Sporothrix schenckii, Exophiala jeikei, Absidia corymbifera, Rhodotorula rubra, Neurospora sitophila, Schizophyllum commune
 Bacteria: Methicillin-resistant Staphylococcus aureus (MRSA), Listeria monocytogenes, Bacillus subtilis, Mycobacterium smegmatis, Nocardia asteroides, Neisseria gonorrhoeae, Salmonella enterica subsp. Enterica, Haemophilus influenzae, Campylobacter jejuni.
^{*4} This verification was designed to generate basic research data on the effects of nanoe™ X on the mould and bacteria in laboratory conditions different from those found in living spaces. It was not designed to evaluate product performance.

Smart comfort with CONEX

CONEX goes beyond simple remote control to combine sophistication with simplicity, offering IoT integration that connects directly to a variety of apps for next-generation solutions.

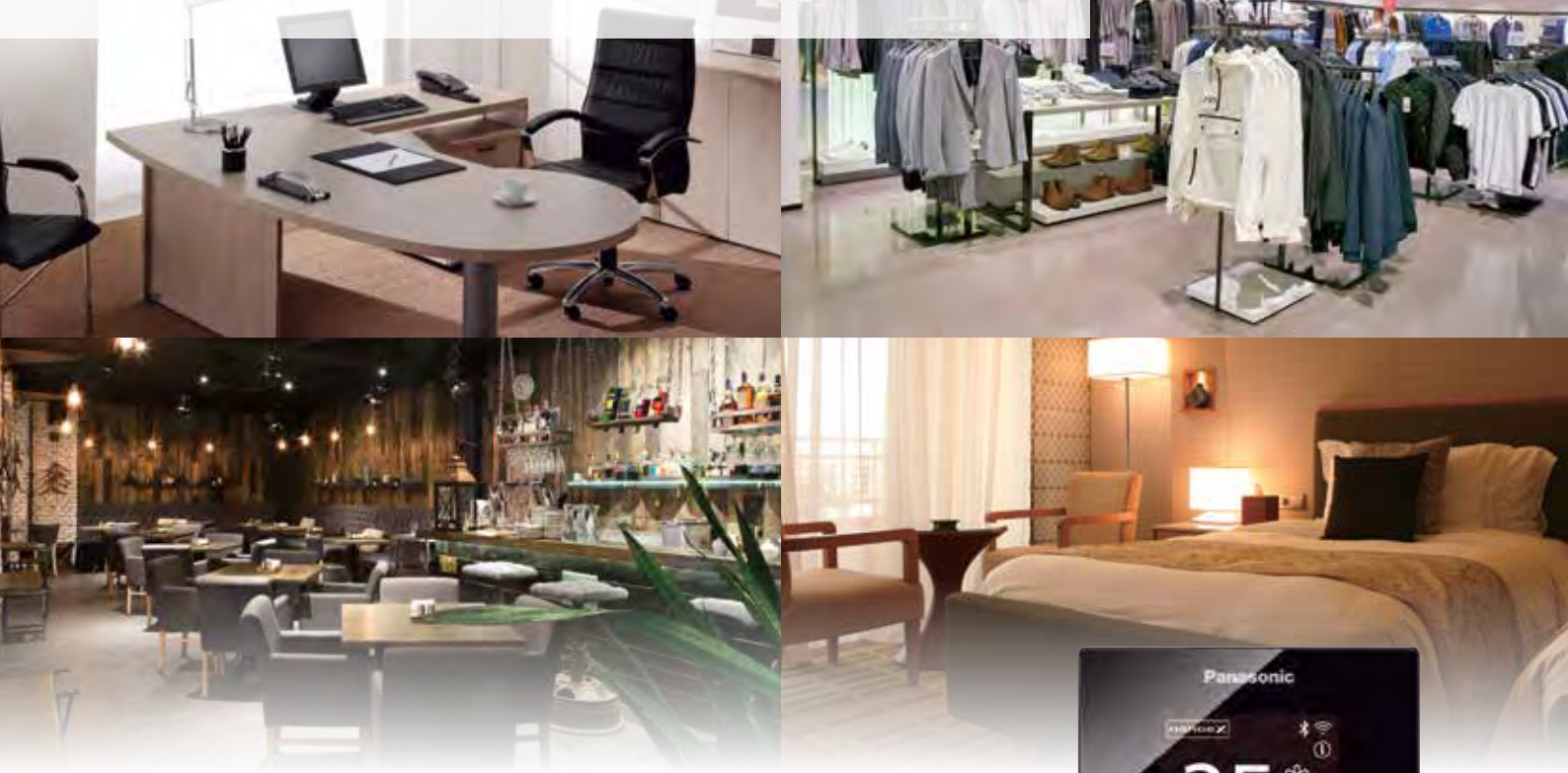

CONEX
(CZ-RTC6BL / CZ-RTC6BLW)

Simple and sophisticated design in-and-out

User friendly interface with stylish design measuring just 86 x 86 mm, CONEX is an extremely compact remote controller which looks great in any room.

Easy control and access for end users, installers, and service partners with just one remote

User-friendly day-to-day operation for end users, simplified set up for installers, and convenient after-sales service access for service partners - all with one remote control.



A next-generation remote control solution optimised for usability, whatever your needs

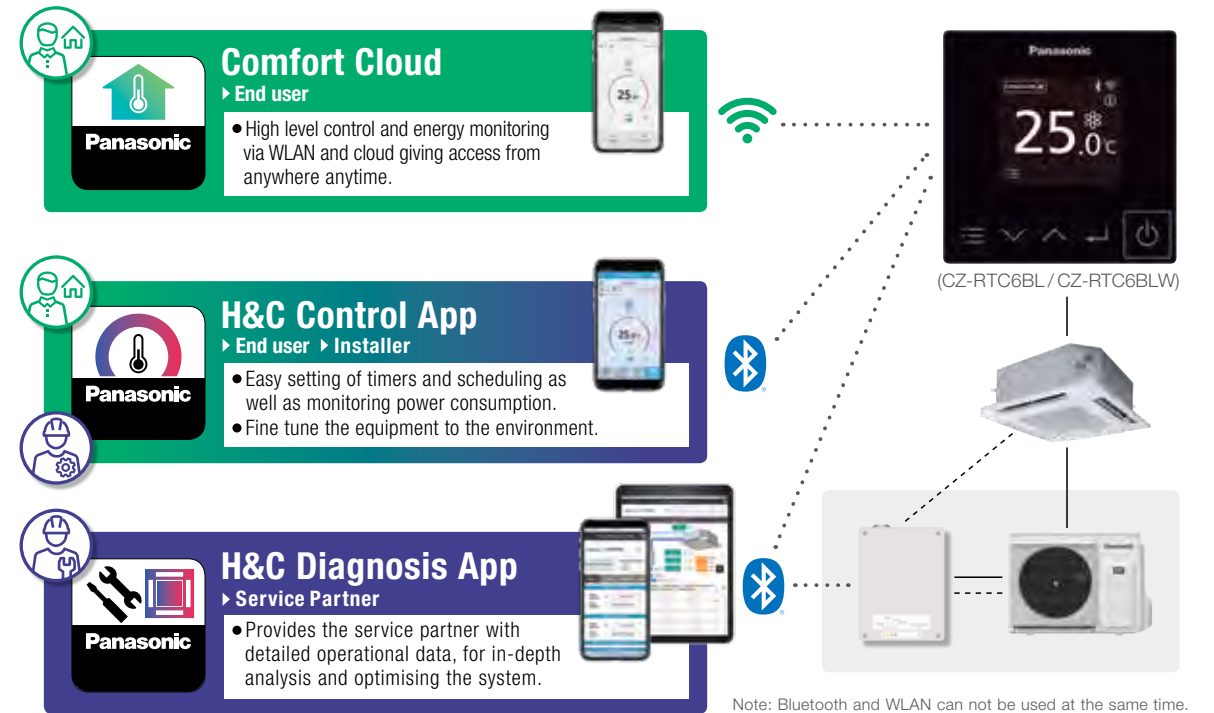

Note: Can be used with new NX series only.

True-comfort for end user- Comfort Cloud App

With Comfort Cloud, even when you are out, at anytime, you can maintain air quality as you please.

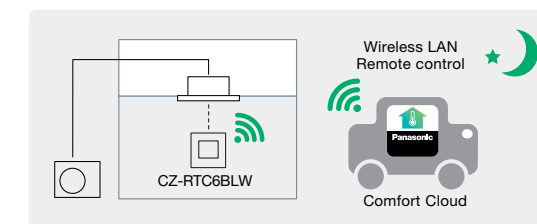

For restaurant owners
Remote control makes 24-hr nanoe™ X air purification*1 in restaurants a reality, even when they're closed.

For shop owners
Air conditioning before opening and give visitors a more comfortable experience.

For boutique hotel owners
Air conditioning before your guests arrive and give them the welcome they deserve.

*1 The nanoe™ X mode can be run independently from cooling or heating mode, and needs to be on for the 24 hour air purification to function.

True-comfort for end user and installer – H&C Control App

H&C Control App makes complex initial set-up easy and allows you to respond swiftly to clients' requests via Bluetooth using a smartphone or tablet.

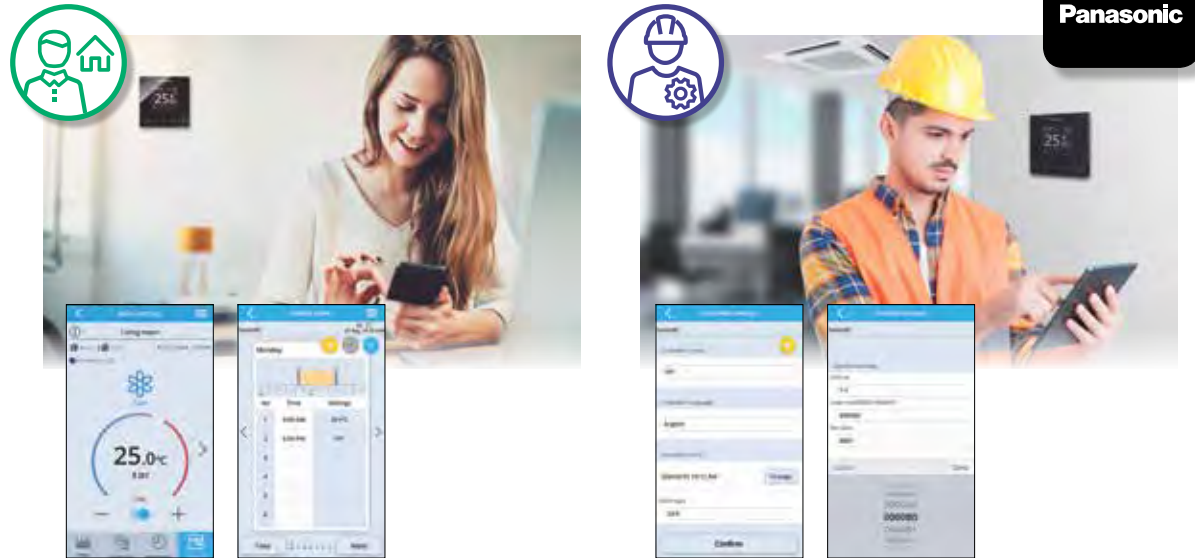

Advantages

Comfort day-to day operations

It's now simpler than ever for end users to further customise settings to meet their needs and perform operations including basic settings.

Intuitive operation for easy configuration

Simplified initial controller configuration together with easy access to comprehensive settings including weekly timer and maintenance.

Straightforward suggestions to clients

Share a single screen with your customer and together tailor everything to meet their needs, from basic setup to weekly timers, all in real time.

Quicker configuration for multiple controllers

Save time with templates - Copy weekly timers and settings to multiple controllers.



True-comfort for service partners – H&C Diagnosis App

The H&C Diagnosis app allows users to intuitively browse current stats and information about an air conditioner via Bluetooth® using a smartphone or tablet and without the need to use a PC.



Advantages

Acquire diagnostic information from both outside and inside

Outdoor diagnosis is now possible via a new service checker interface^{*1}. With CONEX, operation status can be checked and failure can be diagnosed from indoors too. The information you need is now available via both indoor and outdoor units even when site access may be difficult for either indoor or outdoor unit.

^{*1} Available as a spare part, compatible with new NX series only.

Acquire the information you need intuitively and quickly

Easy access to real-time service parameters and service checker data allows for more accurate repairs. Actual real-time operation data can be toggled between system and refrigerant circuit views, and previously recorded data can be viewed in the history. A comprehensive error code table and guide gives details of error codes and how to handle them.



Refrigerant circuit view

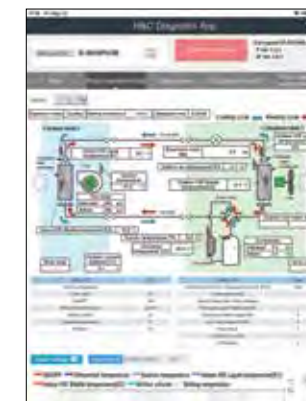

Real time data



History data



New service checker interface (Details are written in P.81)

Maximum versatility adaptive ducted unit

Designed to deliver flexibility, performance, and comfort, Panasonic introduces an industry-leading horizontal/vertical design featuring powerful 150Pa static pressure in a compact unit. Leading-class noise level performance and nanoe™X technology provide comfort that's carried right the way through the ductwork.

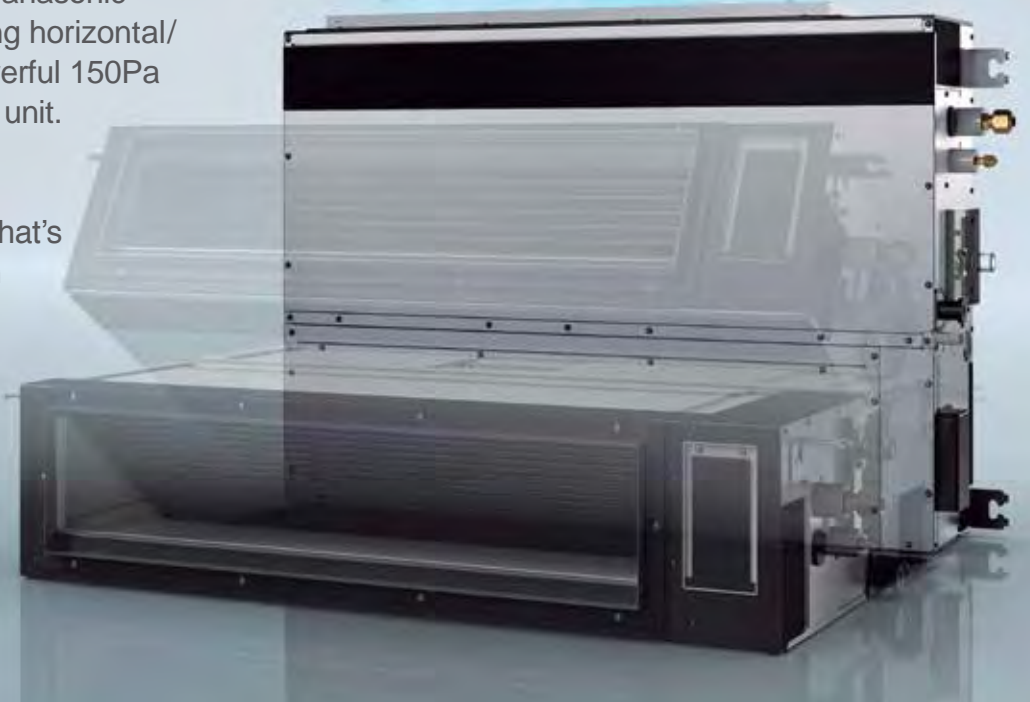

Powerful 150Pa ESP in an industry-leading vertical installation

Our groundbreaking drain pan design delivers a ducted unit that can be mounted horizontally or vertically without the need for alterations*1. Even when ceiling space for ductwork is limited, the slim design and powerful 150Pa static pressure allow for discrete placement away from rooms for total installation flexibility.

*1 Please refer to Installation Manual for full details.

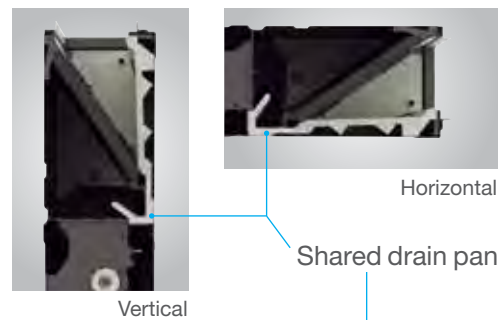

Drain pan is shared in both cases horizontal and vertical installation.

Top-class noise level performance

A proprietary improved casing design realises an even smoother airflow and low noise (22dB - 29dB) operation while effortlessly maintaining enough pressure*2 to deliver quiet comfort ideal for hotel and guest rooms.

*2 Operating at 50Pa static pressure in Low fan mode.

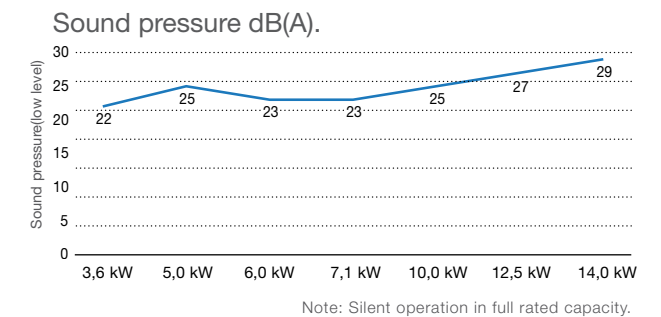
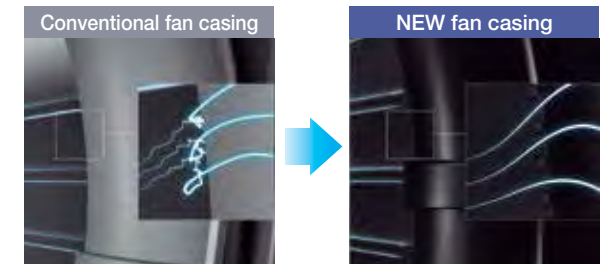

Superior Air Quality nanoe™X

The new ducted models are equipped with nanoe™ X as standard, a unique air quality improvement technology producing twice the amount of hydroxyl radicals compared to previous generations. Combined with the strong static pressure this ensures pristine nanoe™ X air travels unaffected even through multiple duct shapes at lengths of 10m, as well as making them ideal for use in larger spaces.

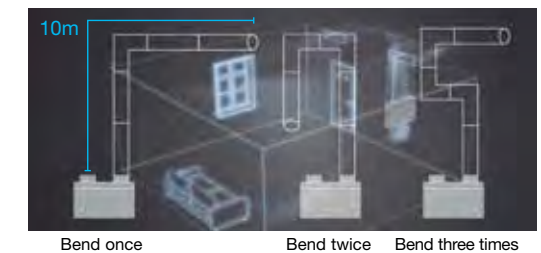

Note: PF3 and PE3 (16.0kW and below) ranges only.

Based on in-house test result, even with a total ductwork length up to 10m, effectiveness of nanoe™ X is maintained.

Power-packed lower profile body

The indoor units have also been completely renewed, offering a 40mm height reduction to only 250mm*3 and a weight reduction of up to 10%, all while maintaining the same powerful 150 Pa.

*3 Compared to previous PF range.

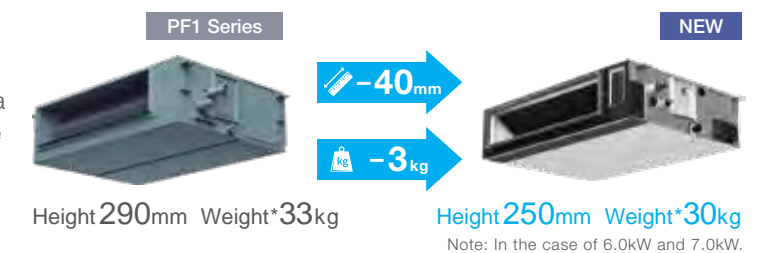

Note: In the case of 6.0kW and 7.0kW.

Selectable air inlet position

The air inlet position is adjustable via a removable panel to allow both rear or bottom entry, depending on the duct installation.

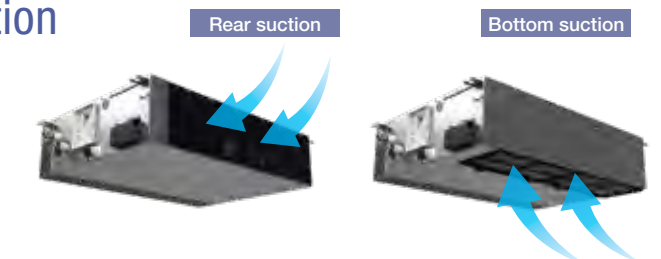

Note: PF3 range only.

Easy to install splittable ducted

Create comfort faster. The newly designed high static pressure ducted model is improved for a more flexible installation. By dividing the unit into 3 components, the burden of installation is reduced.

Note: In the case of the S-180PE3R5B, S-200PE3R5B, and S-224PE3R5B



Easy Installation Design

3 Components For Easy In-Ceiling Assembly

The newly designed high static pressure ducted consists of 3 components, the heat exchanger, the fan and the fan casing. For easy installation, the unit has been designed to be lifted into the roof via return air grille, separated, and easily reassembled when in position.

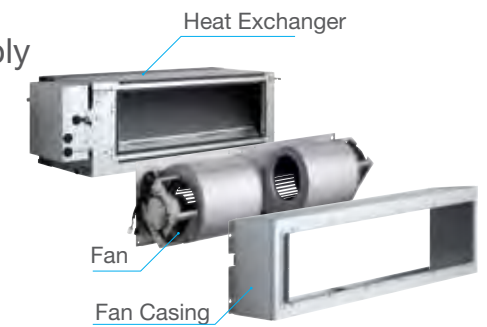

New Ducted Model Key Factors

Bell Shaped Keyhole for Weight Support

Part of the keyhole is newly designed with a bell shape to reduce the burden of installation. It also enables temporary attachment.



2 Wire Connectors for Easy Installation

With only 2 wire connectors, installation has become much easier and faster.

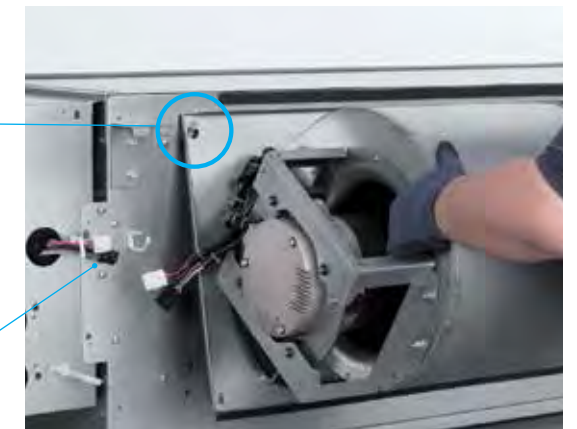

12 Bolts & Screws for Easy Assembly

Only 12 screws and bolts need to be attached, allowing for a shorter installation time.

Even cooling for all rooms

Top Grade of Airflow Volume

Providing powerful air, Panasonic's splittable ducted has increased the rate of airflow by 16%^{*1}, reaching up to 1,400 L/s^{*2}. Its powerful airflow enables faster room temperature control.



3-step Static Pressure Set Up

You can select between the three Static Pressure modes of 200 Pa / 130 Pa / 75 Pa for extra installation flexibility.



Max.200 Pa Static Pressure Setting

A maximum static pressure setting of a powerful 200Pa enables the use of long ducts for installation in a wide range of spaces. Ideal for large-scale houses, offices and restaurants.



Easy Assembly Steps

Assembly takes three easy steps, even in limited spaces.



- 1 Install the fan to the heat exchanger and tighten the screws and bolts.
- 2 Assemble the connectors.
- 3 Install the chassis and tighten the screws and bolts.

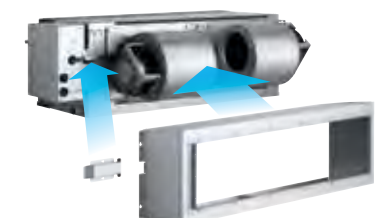

^{*1} Comparison between S-224PE3R5B and S-224PE2R5B ^{*2} In case of S-224PE3R5B

All side discharge R32 outdoor units

Panasonic's new range of outdoor units feature intuitive technology and thoughtful engineering. The two innovative ranges of R32 units, both Deluxe and Compact, feature energy and space saving technologies, permitting installation in even the tightest and most demanding conditions.



More Efficient, Less Space

Whilst maintaining its strong power, new R32 outdoor units get smaller. This enables them to fit into tighter spaces. Thus you can install these units in a vast variety of areas.

All side discharge from 6.0kw to 22.4kW

R32 Deluxe



Industry-leading Small Body with All 1-fan Models

R32 Compact

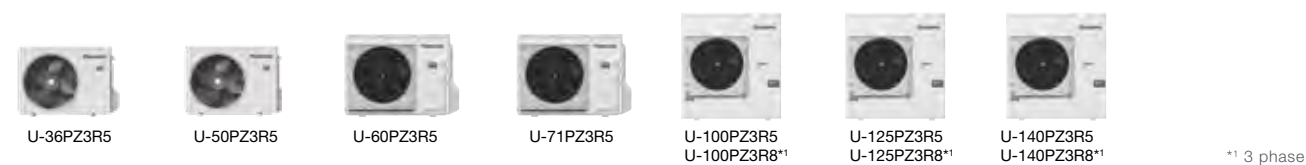

Precise Temperature Control

Constant Comfort Air Conditioning

R32 Deluxe

Another advantage of Panasonic Premium Inverter technology includes its ability to ensure precise temperature control and offer a wider power output range to perform in even the most extreme conditions in Australia, ensuring constant comfort.

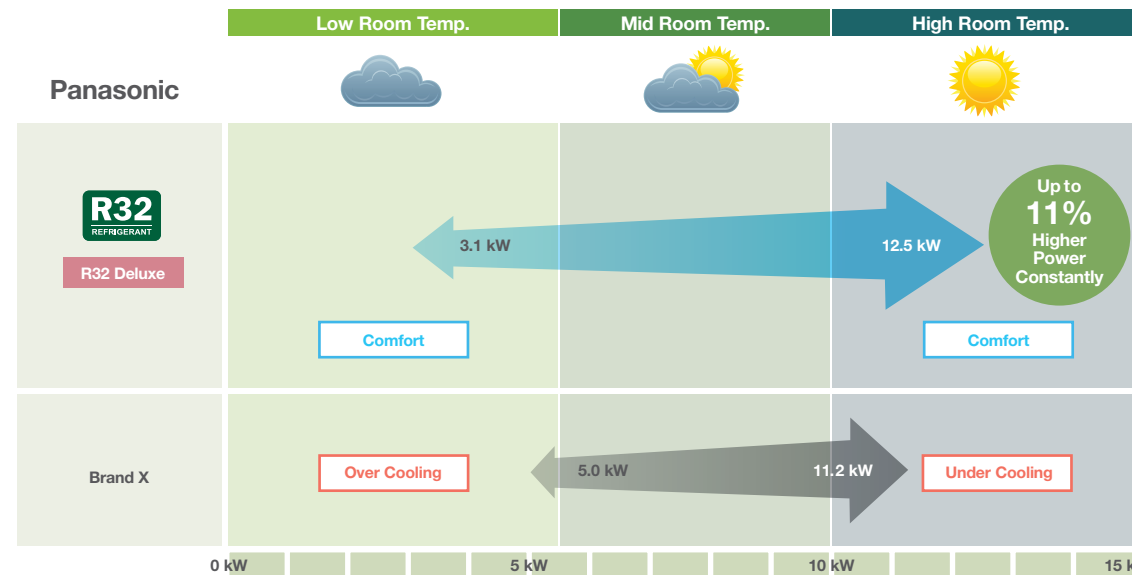

Graph shows each models' 10.0 kW Inverter High Static Pressure Ducted systems performance range during cooling.

NX Series - Refurbishing Made Easy

The new NX series has been developed to use 3-wired communication, making it simple to replace the three wire systems often used in older installations.

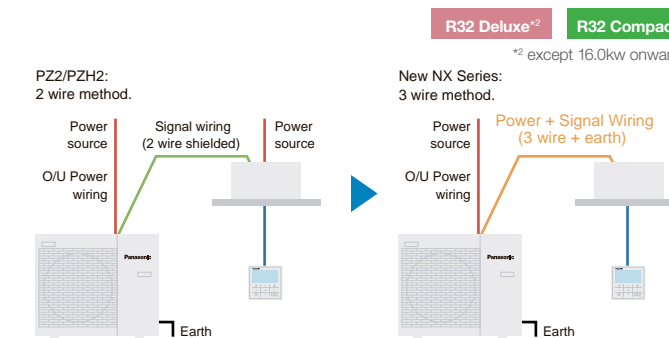

R22 Renewal. Fast, easy to install and cost-effective

Panasonic refrigerant oil is engineered to avoid the damage to units that can happen when oil types commonly found in air-conditioning systems react with each other. As well as preventing damage, this makes replacing R22 systems with the latest R32 model as simple as reusing the existing piping and replacing the indoor and outdoor unit. Switching to the latest R32 system also improves energy efficiency by approximately 30% compared to the R22 system.

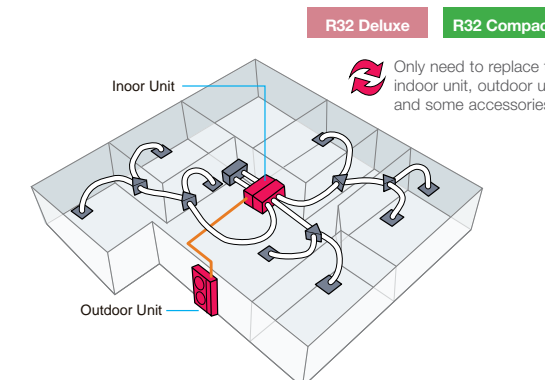

Note: Only use existing piping after checking "IN CASE OF REUSING EXISTING REFRIGERANT PIPING" in the installation manual.

Outdoor Unit

Outdoor Unit Dimensions

Next Generation Refrigerant: R32

R32, an innovative refrigerant in all ways imaginable: it is easy to install, and compared to most other refrigerants it has a much lower environmental impact and saves energy.

R32 Deluxe R32 Compact

- Low Global Warming Potential (GWP): 75% less impact on global warming vs R410A
- Energy Efficient: Higher energy efficiency than R410A
- Easy Installation: This refrigerant is 100% pure which makes it easier to recycle and reuse.

Energy Saving Technology

The use of energy saving design for the structure of fans, fan motors, compressors and heat exchangers results in high TCSPF and HSPF value, which ranks as one of the top in the industry.



* The graph shows 4-WAY Cassette R32 Deluxe models values.
* TCSPF/HSPF is based on Commercial (Average)

Other Advanced Technology

Increased Piping Length for Greater Design Flexibility

R32 Deluxe

Adaptable to various building types and sizes
Max. piping length :
50m (7.1kW),
85m (10.0kW-14.0kW),
75m (16.0kW, 18.0kW)
60m (20.0kW, 22.4kW)

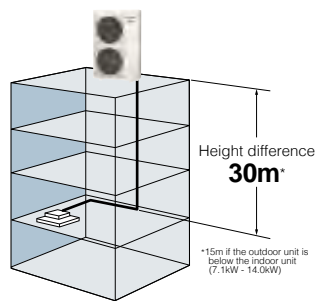

Product Quality and Safety

R32 Compact R32 Deluxe

All Panasonic air conditioners undergo strict quality and safety tests before sale. This rigorous process includes obtaining all necessary Safety Approvals, to ensure that all air conditioners we sell are not only built to the highest market standards, but are also completely safe.



Quiet Mode

R32 Compact R32 Deluxe

Quiet mode reduces outdoor operating sound by 2dB. External input signal is also available.

Demand Response Compliant

R32 Compact R32 Deluxe

Panasonic air conditioners are equipped with a Demand Response Enabling Device (DRED) which complies to both AS 4755 and AS 3823. Panasonic continues to design and develop products that are tailored to local needs and requirements.

The Equipment Energy Efficiency (E3) program has been supporting the development of DRED standards for air-conditioners which should comply with AS 4755. The functionality will be required for all installations in the very near future

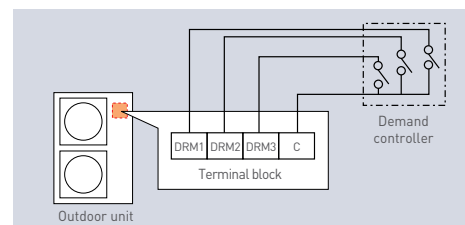

Demand control terminal is available to control 0-50-75-100% of capacities.

Deluxe Model

R32 Deluxe Model Dimensions (7.1kW)

U-71PZH3R5

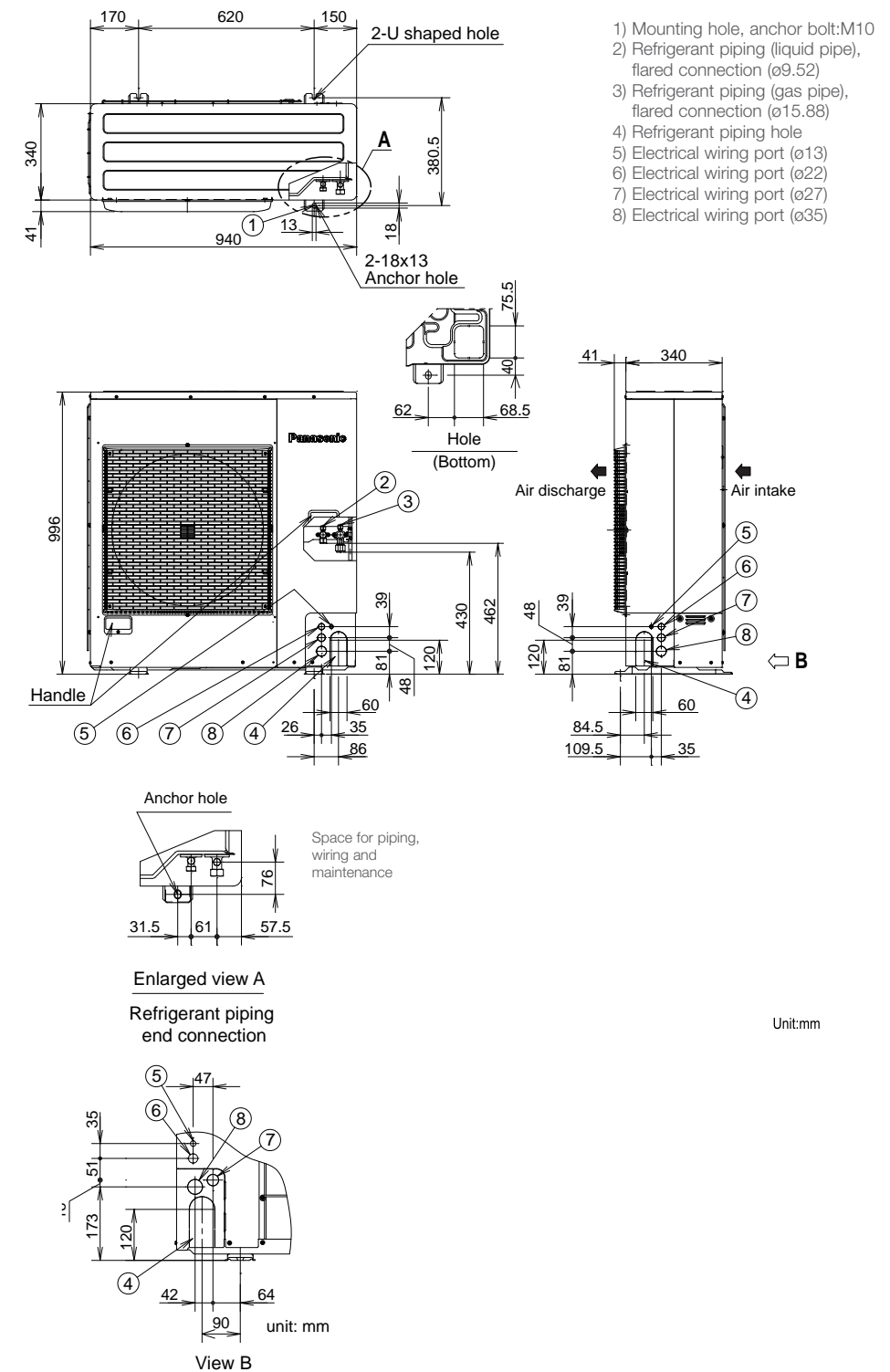

Outdoor Unit Dimensions

Compact Model

R32 Compact Model Dimensions (3.5kW – 5.0kW)

U-36PZ3R5 / U-50PZ3R5

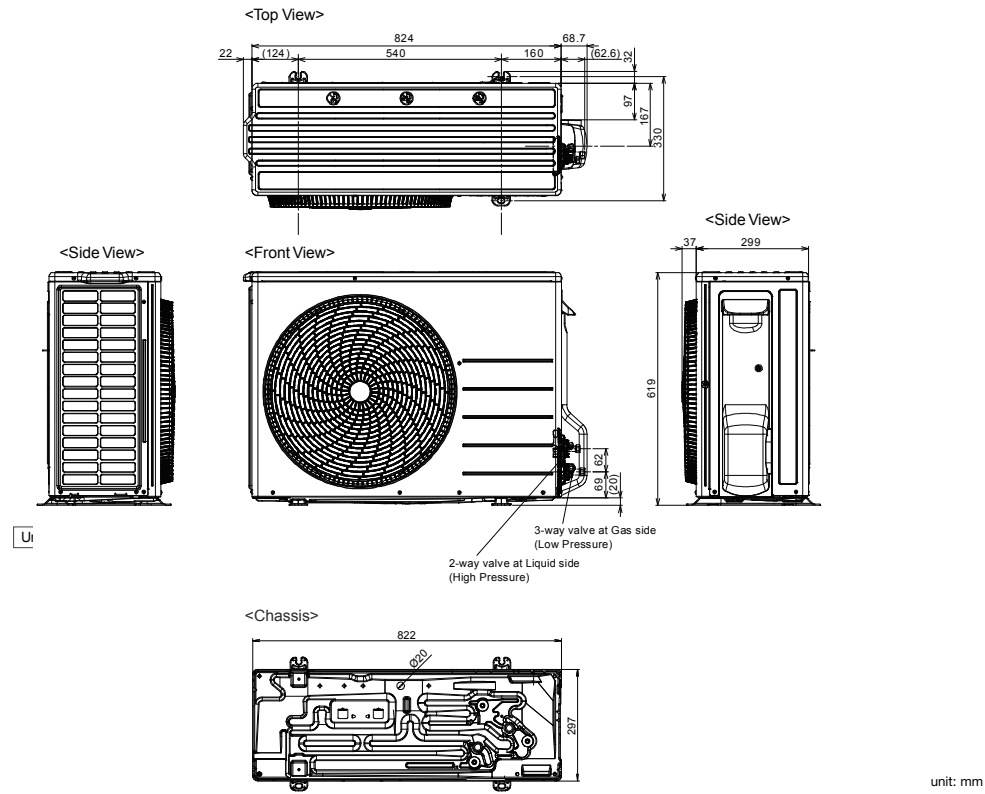

R32 Compact Model Dimensions (10.0kW – 14.0kW)

U-100PZ3R5 / U-100PZ3R8 / U-125PZ3R5 / U-125PZ3R8 / U-140PZ3R5 / U-140PZ3R8

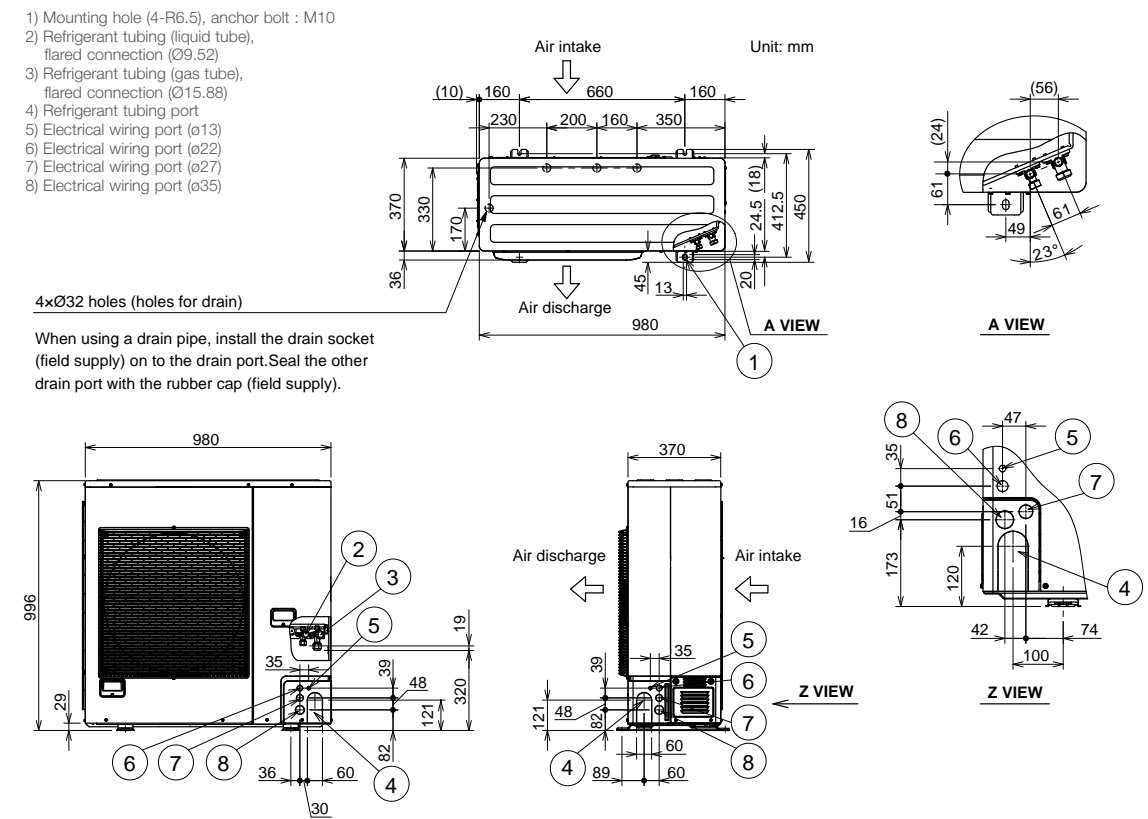

R32 Compact Model Dimensions (6.0kW – 7.1kW)

U-60PZ3R5 / U-71PZ3R5

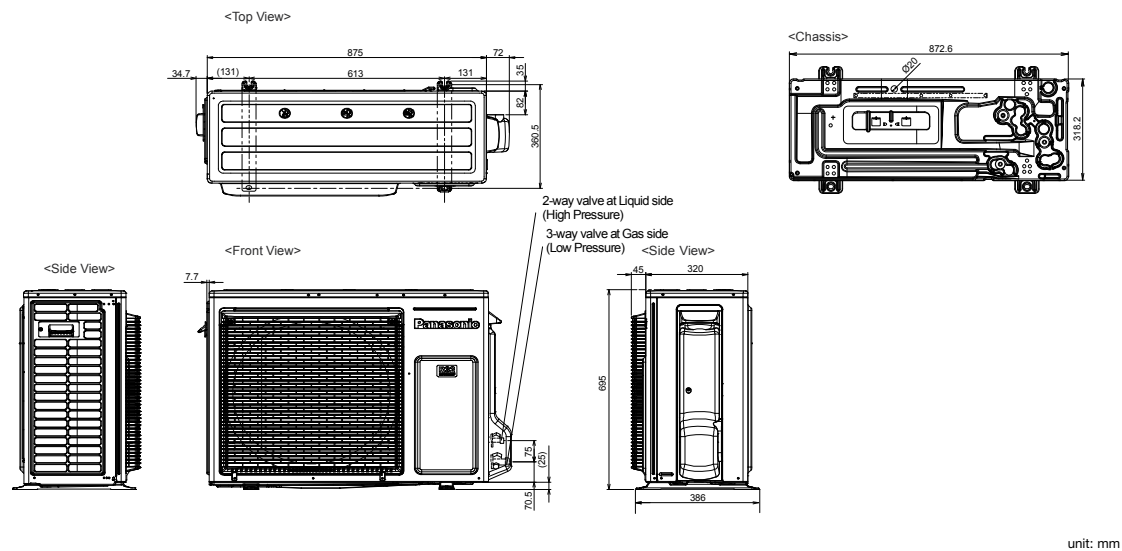

Outdoor Unit Dimensions

R32 Model

Dimensions (2.5kW – 2.6kW)
CU-Z25UBRA

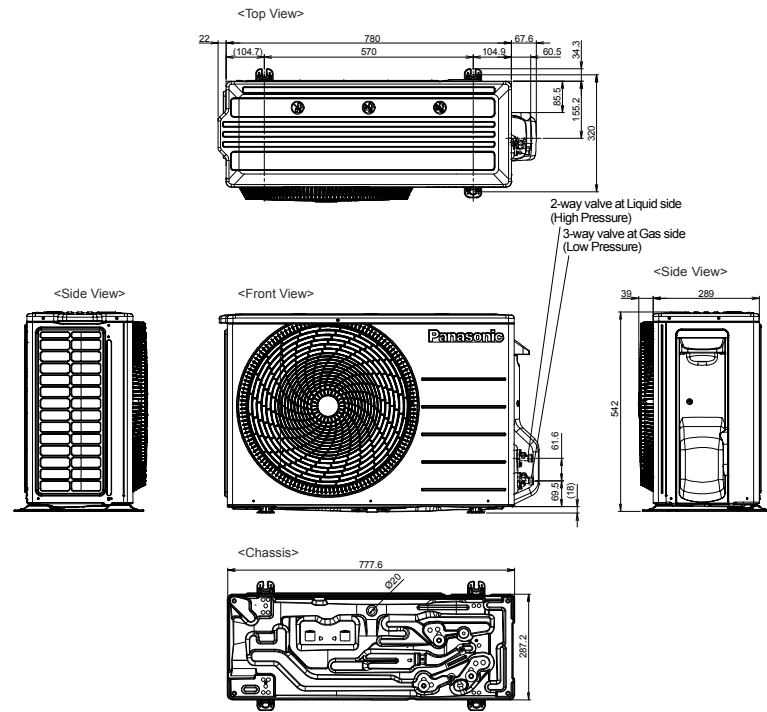

unit: mm

Dimensions (4.8kW – 5.7kW)
CU-Z50UBRA / CU-Z60UBRA

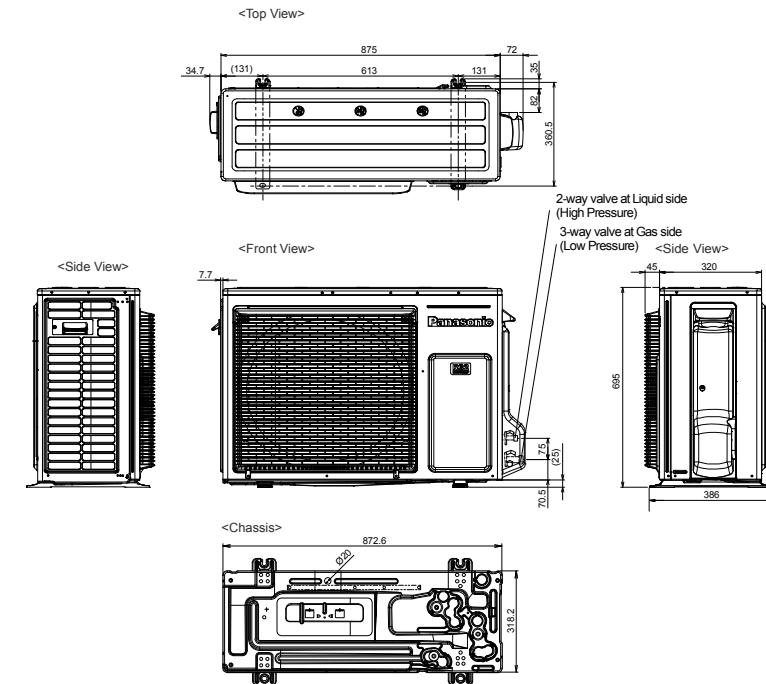

unit: mm

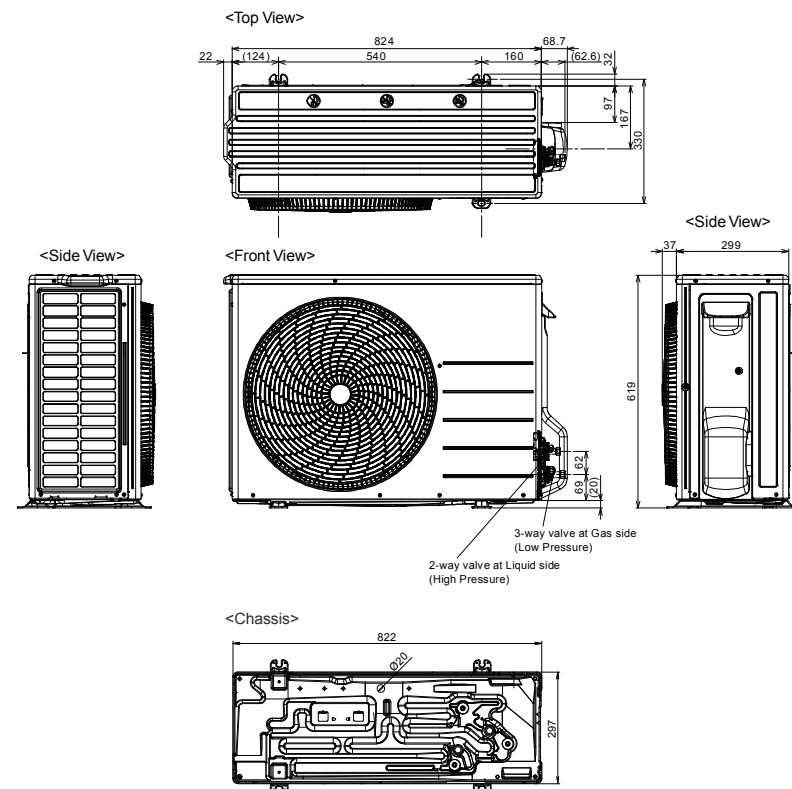

Dimensions (3.5kW – 3.7kW)
CU-Z35UBRA



unit: mm

Indoor Unit High Static Pressure Ducted

High static and large airflow ducted for exceptional installation flexibility.

- 
 Self-diagnosing Function
- 
 Automatic Fan Operation
- 
 Dry mode
- 
 Automatic Restart Function
- 
 DC Motor*
*1 only for 6.0-12.5kw

 nanoe™ X as a standard*
*nanoe X Generator Mark 2

 ECONAVI ready



Technical focus

- Design flexibility thanks to high static pressure and large air volume
 - Accurate temperature control to reduce cold drafts during operation
- Configurable air temperature control

Compact Body Size

Hidden in the ceiling, ideal when interior decor is an important consideration such as in residences with many rooms and light commercial buildings.

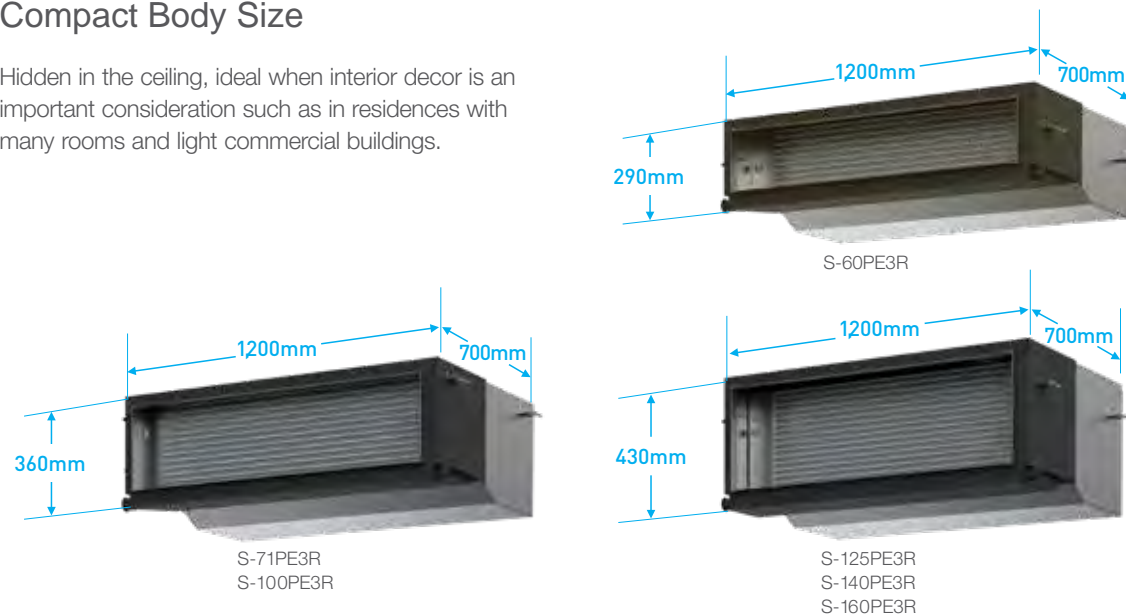

System Example

An inspection port (450 mm x 450 mm or more) is required at the control-box side of the indoor unit body.

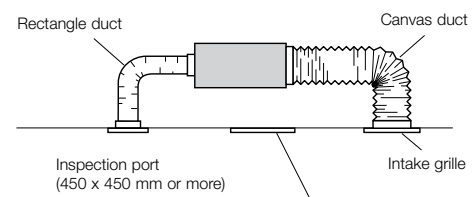

Clean air. Ducts that deliver

Testing has verified that even with three bends and a total length of up to 10m, the effectiveness of nanoe™ X is maintained right through the duct to deliver clean, fresh air where it's needed.

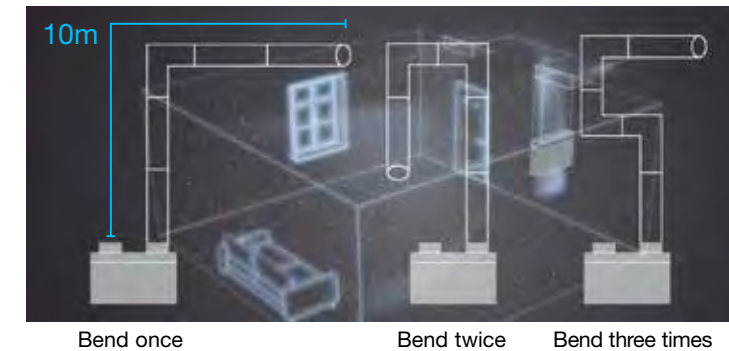

As the experiments demonstrate; even with a total ductwork length of up to 10m, effectiveness of nanoe™ X is maintained.

Note: PF3 and PE3 (16.0kW and below) ranges only.

Cold Drafts Reduced During Heating Operation

- Accurate temperature measurement by E1/E2 sensor to reduce cold drafts during heating operation.

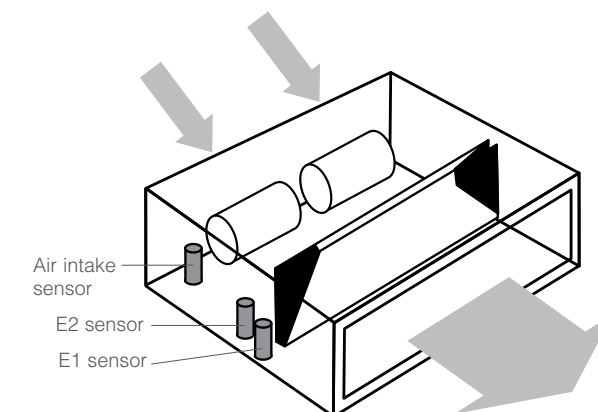

Indoor Unit: High Static Pressure Ducted

High Static Pressure Duct R32 Deluxe model



Capacity		7.1kW		10.0kW		12.5kW		14.0kW		16.0kW	
Model Name	Indoor Unit	S-71PE3R	S-100PE3R	S-100PE3R	S-125PE3R	S-125PE3R	S-140PE3R	S-140PE3R	S-160PE3R	S-160PE3R	
	Outdoor Unit	U-71PZH3R5	U-100PZH3R5	U-100PZH3R8	U-125PZH3R5	U-125PZH3R8	U-140PZH3R5	U-140PZH3R8	U-160PZH2R5	U-160PZH2R8	
Cooling capacity : Heating capacity	kW	7.1 (2.2 - 9.0) 8.0 (2.0 - 9.0)	10.0 (3.1 - 12.5) 11.2 (3.1 - 14.0)	10.0 (3.1 - 12.5) 11.2 (3.1 - 14.0)	12.5 (3.2 - 14.0) 14.0 (3.2 - 16.0)	12.5 (3.2 - 14.0) 14.0 (3.2 - 16.0)	14.0 (3.3 - 16.0) 16.0 (3.3 - 18.0)	14.0 (3.3 - 16.0) 16.0 (3.3 - 18.0)	16.0 (5.5 - 18.0) 18.0 (5.5 - 20.0)	16.0 (5.5 - 18.0) 18.0 (5.5 - 20.0)	
	BTU/h	24,200 (7,500 - 30,700) 27,300 (6,800 - 30,700)	34,100 (10,600 - 42,700) 38,200 (10,600 - 47,800)	34,100 (10,600 - 42,700) 38,200 (10,600 - 47,800)	42,700 (10,900 - 47,800) 47,800 (10,900 - 54,600)	42,700 (10,900 - 47,800) 47,800 (10,900 - 54,600)	47,800 (11,300 - 54,600) 54,600 (11,300 - 61,400)	47,800 (11,300 - 54,600) 54,600 (11,300 - 61,400)	54,600 (18,800 - 61,400) 61,400 (18,800 - 68,200)	54,600 (18,800 - 61,400) 61,400 (18,800 - 68,200)	
EER : COP	W/W	3.48 : 3.88	3.79 : 3.78	3.79 : 3.78	3.57 : 3.80	3.57 : 3.80	3.26 : 3.68	3.26 : 3.68	3.29 : 3.53	3.29 : 3.53	
COP@H2 condition	W/W	2.80	2.77	2.77	2.72	2.72	2.65	2.65	2.81	2.81	
Total power input	kW	2.04 : 2.06	2.64 : 2.96	2.64 : 2.96	3.50 : 3.68	3.50 : 3.68	4.30 : 4.35	4.30 : 4.35	4.86 : 5.10	4.86 : 5.10	
TCSPF : HSPF	Residential	Cooling : Heating	4.11 : 4.22	4.46 : 4.34	4.46 : 4.34	4.49 : 4.40	4.49 : 4.40	3.92 : 4.07	3.92 : 4.07	3.80 : 3.99	3.80 : 3.99
		Hot Climate	4.68 : 4.82	5.04 : 5.10	5.04 : 5.10	4.92 : 5.17	4.92 : 5.17	4.29 : 4.69	4.29 : 4.69	4.21 : 4.61	4.21 : 4.61
		Average Climate	4.11 : 4.22	4.46 : 4.34	4.46 : 4.34	4.49 : 4.40	4.49 : 4.40	3.92 : 4.07	3.92 : 4.07	3.80 : 3.99	3.80 : 3.99
	Commercial	Cooling : Heating	4.19 : 3.79	4.54 : 3.93	4.54 : 3.93	4.60 : 3.90	4.60 : 3.90	4.03 : 3.62	4.03 : 3.62	3.85 : 3.55	3.85 : 3.55
		Hot Climate	5.15 : 4.85	5.55 : 5.15	5.55 : 5.15	5.36 : 5.23	5.36 : 5.23	4.63 : 4.74	4.63 : 4.74	4.53 : 4.63	4.53 : 4.63
		Average Climate	5.00 : 4.52	5.47 : 4.73	5.47 : 4.73	5.55 : 4.80	5.55 : 4.80	4.60 : 4.39	4.60 : 4.39	4.54 : 4.28	4.54 : 4.28
Cooling : Heating	5.37 : 4.11	5.87 : 4.32	5.87 : 4.32	5.97 : 4.31	5.97 : 4.31	4.91 : 3.96	4.91 : 3.96	4.80 : 3.88	4.80 : 3.88		
Indoor Unit		1 Phase / 50Hz		1 Phase / 50Hz		1 Phase / 50Hz		1 Phase / 50Hz		1 Phase / 50Hz	
Power source	Phase/Hz	1 Phase / 50Hz	1 Phase / 50Hz	1 Phase / 50Hz	1 Phase / 50Hz	1 Phase / 50Hz	1 Phase / 50Hz	1 Phase / 50Hz	1 Phase / 50Hz	1 Phase / 50Hz	
Current (rated)	Cooling : Heating	230V 240V	230V 240V	230V 240V	230V 240V	230V 240V	230V 240V	230V 240V	230V 240V	230V 240V	
Dimension	H x W x D	360 X 1,200 X 700	360 X 1,200 X 700	360 X 1,200 X 700	430 X 1,200 X 700	430 X 1,200 X 700	430 X 1,200 X 700	430 X 1,200 X 700	430 X 1,200 X 700	430 X 1,200 X 700	
Net weight	Indoor	36	37	37	41	41	50	50	50	50	
Air volume (H/M/L)	Cooling : Heating	L/s	501 / 434 / 367 : 501 / 434 / 367	668 / 584 / 484 : 668 / 584 / 484	668 / 584 / 484 : 668 / 584 / 484	835 / 768 / 601 : 835 / 768 / 601	835 / 768 / 601 : 835 / 768 / 601	1,002 / 835 / 701 : 1,002 / 835 / 701	1,002 / 835 / 701 : 1,002 / 835 / 701	1,002 / 835 / 701 : 1,002 / 835 / 701	1,002 / 835 / 701 : 1,002 / 835 / 701
External static pressure	Pa	100 (10 - 150)	100 (10 - 150)	100 (10 - 150)	100 (10 - 150)	100 (10 - 150)	100 (50 - 150*)	100 (50 - 150*)	100 (50 - 150*)	100 (50 - 150*)	
Sound pressure level (H/M/L)	Cooling : Heating	dB(A)	45 / 44 / 43 : 45 / 44 / 43	48 / 46 / 44 : 48 / 46 / 44	48 / 46 / 44 : 48 / 46 / 44	49 / 47 / 45 : 49 / 47 / 45	49 / 47 / 45 : 49 / 47 / 45	51 / 49 / 47 : 51 / 49 / 47	51 / 49 / 47 : 51 / 49 / 47	51 / 49 / 47 : 51 / 49 / 47	
Sound power level (H/M/L)	Cooling : Heating	dB	62 / 61 / 60 : 62 / 61 / 60	70 / 68 / 66 : 70 / 68 / 66	70 / 68 / 66 : 70 / 68 / 66	71 / 69 / 67 : 71 / 69 / 67	71 / 69 / 67 : 71 / 69 / 67	73 / 71 / 69 : 73 / 71 / 69	73 / 71 / 69 : 73 / 71 / 69	73 / 71 / 69 : 73 / 71 / 69	
Number of fan speeds		3	3	3	3	3	3	3	3	3	
Drain piping	mm	VP-25	VP-25	VP-25	VP-25	VP-25	VP-25	VP-25	VP-25	VP-25	
Outdoor Unit		1 Phase / 50Hz		1 Phase / 50Hz		3 Phase / 50Hz		1 Phase / 50Hz		3 Phase / 50Hz	
Power source	Phase/Hz	1 Phase / 50Hz	1 Phase / 50Hz	3 Phase / 50Hz	1 Phase / 50Hz	3 Phase / 50Hz	1 Phase / 50Hz	3 Phase / 50Hz	1 Phase / 50Hz	3 Phase / 50Hz	
Current (rated)	Cooling : Heating	A	9.85 : 9.95 9.55 : 9.65	12.8 : 14.3 12.2 : 13.7	4.25 : 4.75 4.15 : 4.60	16.7 : 17.6 16.0 : 16.8	5.60 : 5.90 5.40 : 5.70	19.7 : 19.9 18.9 : 19.1	6.60 : 6.70 6.35 : 6.45	20.0 : 21.1 19.1 : 20.1	6.95 : 7.30 6.65 : 7.00
Dimension	H x W x D	996 x 940 x 340	1,416 x 940 x 340	1,416 x 940 x 340	1,416 x 940 x 340	1,416 x 940 x 340	1,416 x 940 x 340	1,416 x 940 x 340	1,500 x 980 x 370	1,500 x 980 x 370	
Net weight	Indoor	66	99	99	99	99	99	117	117	115	
Air volume	Cooling : Heating	L/s	1,018 : 1,002	1,970 : 1,803	1,970 : 1,803	2,087 : 1,870	2,087 : 1,870	2,154 : 1,937	2,154 : 1,937	2,738 : 2,738	
Sound pressure level (Silent mode)	Cooling : Heating	dB(A)	48 (46) : 50 (48)	52 (50) : 52 (50)	52 (50) : 52 (50)	53 (51) : 53 (51)	54 (52) : 54 (52)	54 (52) : 54 (52)	58 (56) : 60 (58)	58 (56) : 60 (58)	
Sound power level (Silent mode)	Cooling : Heating	dB	64 (62) : 66 (64)	68 (66) : 68 (66)	68 (66) : 68 (66)	69 (67) : 69 (67)	70 (68) : 70 (68)	70 (68) : 70 (68)	76 (74) : 78 (76)	76 (74) : 78 (76)	
Piping connections	Liquid / Gas	mm	Ø9.52 / Ø15.88	Ø9.52 / Ø15.88	Ø9.52 / Ø15.88	Ø9.52 / Ø15.88	Ø9.52 / Ø15.88	Ø9.52 / Ø15.88	Ø9.52 / Ø19.05	Ø9.52 / Ø19.05	
Pipe length range	min. - max.	m	5 - 50	5 - 85	5 - 85	5 - 85	5 - 85	5 - 85	5 - 75	5 - 75	
Elevation difference (OU located lower, OU located higher)	m	15, 30	15, 30	15, 30	15, 30	15, 30	15, 30	15, 30	30, 30	30, 30	
Maximum chargeless length	m	30	30	30	30	30	30	30	30	30	
Refrigerant at shipping / Additional gas amount	g	R32 1,950 / 45 (g/m)	R32 3,050 / 45 (g/m)	R32 3,050 / 45 (g/m)	R32 3,050 / 45 (g/m)	R32 3,050 / 45 (g/m)	R32 3,050 / 45 (g/m)	R32 3,050 / 45 (g/m)	R32 3,200 / 45 (g/m)	R32 3,200 / 45 (g/m)	
Operating range	Cooling : Heating	°C	-15 to 48 : -20 to 24	-15 to 48 : -20 to 24	-15 to 48 : -20 to 24	-15 to 48 : -20 to 24	-15 to 48 : -20 to 24	-15 to 48 : -20 to 24	-15 to 46 : -20 to 24	-15 to 46 : -20 to 24	

Specifications of R32 Compact Model



Capacity		6.0kW		7.1kW		10.0kW		12.5kW		14.0kW	
Model Name	Indoor Unit	S-60PE3R	S-71PE3R	S-100PE3R	S-100PE3R	S-125PE3R	S-125PE3R	S-140PE3R	S-140PE3R	S-140PE3R	
	Outdoor Unit	U-60PZ3R5	U-71PZ3R5	U-100PZ3R5	U-100PZ3R8	U-125PZ3R5	U-125PZ3R8	U-140PZ3R5	U-140PZ3R8	U-140PZ3R8	
Cooling capacity : Heating capacity	kW	6.0 (2.0 - 7.1) 6.0 (1.8 - 7.0)	7.1 (2.6 - 7.7) 7.1 (2.1 - 8.1)	10.0 (3.0 - 11.5) 10.0 (3.0 - 14.0)	10.0 (3.0 - 11.5) 10.0 (3.0 - 14.0)	12.5 (3.2 - 13.5) 12.5 (3.3 - 15.0)	12.5 (3.2 - 13.5) 12.5 (3.3 - 15.0)	14.0 (3.3 - 15.0) 14.0 (3.4 - 16.0)	14.0 (3.3 - 15.0) 14.0 (3.4 - 16.0)	14.0 (3.3 - 15.0) 14.0 (3.4 - 16.0)	
	BTU/h	20,500 (6,800 - 24,200) 20,500 (6,100 - 23,900)	24,200 (8,900 - 26,300) 24,200 (7,200 - 27,600)	34,100 (10,200 - 39,200) 34,100 (10,200 - 47,800)	34,100 (10,200 - 39,200) 34,100 (10,200 - 47,800)	42,700 (10,900 - 46,100) 42,700 (11,300 - 51,200)	42,700 (10,900 - 46,100) 42,700 (11,300 - 51,200)	47,800 (11,300 - 51,200) 47,800 (11,600 - 54,600)	47,800 (11,300 - 51,200) 47,800 (11,600 - 54,600)	47,800 (11,300 - 51,200) 47,800 (11,600 - 54,600)	
EER : COP	W/W	3.26 : 4.08	3.21 : 4.25	3.58 : 4.08	3.58 : 4.08	3.55 : 4.03	3.55 : 4.03	3.25 : 3.76	3.25 : 3.76	3.25 : 3.76	
COP@H2 condition	W/W	3.00	3.11	2.88	2.88	2.56	2.56	2.68	2.68	2.68	
Total power input	kW	1.84 : 1.47	2.21 : 1.67	2.79 : 2.45	2.79 : 2.45	3.52 : 3.10	3.52 : 3.10	4.31 : 3.72	4.31 : 3.72	4.31 : 3.72	
TCSPF : HSPF	Residential	Cooling : Heating	3.98 : 3.95	3.96 : 4.05	4.64 : 3.95	4.64 : 3.95	4.60 : 3.93	4.60 : 3.93	4.27 : 3.79	4.27 : 3.79	4.27 : 3.79
		Hot Climate	3.56 : 3.88	3.59 : 4.00	4.17 : 3.81	4.17 : 3.81	4.16 : 3.79	4.16 : 3.79	3.92 : 3.64	3.92 : 3.64	3.92 : 3.64
		Average Climate	3.56 : 3.88	3.59 : 4.00	4.17 : 3.81	4.17 : 3.81	4.16 : 3.79	4.16 : 3.79	3.92 : 3.64	3.92 : 3.64	3.92 : 3.64
	Commercial	Cooling : Heating	3.58 : 3.59	3.63 : 3.70	4.23 : 3.55	4.23 : 3.55	4.26 : 3.47	4.26 : 3.47	4.03 : 3.34	4.03 : 3.34	4.03 : 3.34
		Hot Climate	4.25 : 3.83	4.22 : 3.91	4.99 : 3.90	4.99 : 3.90	4.96 : 3.84	4.96 : 3.84	4.56 : 3.70	4.56 : 3.70	4.56 : 3.70
		Average Climate	4.16 : 3.74	4.19 : 3.83	4.98 : 3.80	4.98 : 3.80	4.88 : 3.73	4.88 : 3.73	4.53 : 3.58	4.53 : 3.58	4.53 : 3.58
Cooling : Heating	4.38 : 3.58	4.41 : 3.67	5.28 : 3.61	5.28 : 3.61	5.20 : 3.52	5.20 : 3.52	4.81 : 3.40	4.81 : 3.40	4.81 : 3.40		
Indoor Unit		1 Phase / 50Hz		1 Phase / 50Hz		1 Phase / 50Hz		1 Phase / 50Hz		1 Phase / 50Hz	
Power source	Phase/Hz	1 Phase / 50Hz	1 Phase / 50Hz	1 Phase / 50Hz	1 Phase / 50Hz	1 Phase / 50Hz	1 Phase / 50Hz	1 Phase / 50Hz	1 Phase / 50Hz	1 Phase / 50Hz	
Current (rated)	Cooling : Heating	A	8.50 : 6.85 8.15 : 6.60	10.3 : 8.00 9.90 : 7.65	13.9 : 12.4 13.4 : 11.9	4.45 : 3.90 4.25 : 3.70	17.0 : 15.0 16.3 : 14.4	5.40 : 4.80 5.20 : 4.55	19.7 : 17.0 18.9 : 16.3	6.80 : 5.70 6.40 : 5.50	6.80 : 5.70 6.40 : 5.50
Dimension	H x W x D	290 x 1,200 x 700	360 x 1,200 x 700	360 x 1,200 x 700	360 x 1,200 x 700	430 x 1,200 x 700	430 x 1,200 x 700	430 x 1,200 x 700	430 x 1,200 x 700	430 x 1,200 x 700	
Net weight	Indoor / Panel	31	36	37	37	41	41	50	50	50	
Air volume (H/M/L)	Cooling : Heating	L/s	367 / 334 / 267 : 367 / 334 / 267	501 / 434 / 367 : 501 / 434 / 367	668 / 584 / 484 : 668 / 584 / 484	668 / 584 / 484 : 668 / 584 / 484	835 / 768 / 601 : 835 / 768 / 601	835 / 768 / 601 : 835 / 768 / 601	1,002 / 835 / 701 : 1,002 / 835 / 701	1,002 / 835 / 701 : 1,002 / 835 / 701	1,002 / 835 / 701 : 1,002 / 835 / 701
External static pressure	Pa	70 (10 - 150)	100 (10 - 150)	100 (10 - 150)	100 (10 - 150)	100 (10 - 150)	100 (10 - 150)	100 (50 - 150*)	100 (50 - 150*)	100 (50 - 150*)	
Sound pressure level (H/M/L)	Cooling : Heating	dB(A)	43 / 41 / 40 : 43 / 41 / 40	45 / 44 / 43 : 45 / 44 / 43	48 / 46 / 44 : 48 / 46 / 44	48 / 46 / 44 : 48 / 46 / 44	49 / 47 / 45 : 49 / 47 / 45	49 / 47 / 45 : 49 / 47 / 45	51 / 49 / 47 : 51 / 49 / 47	51 / 49 / 47 : 51 / 49 / 47	
Sound power level (H/M/L)	Cooling : Heating	dB	60 / 58 / 57 : 60 / 58 / 57	62 / 61 / 60 : 62 / 61 / 60	70 / 68 / 66 : 70 / 68 / 66	70 / 68 / 66 : 70 / 68 / 66	71 / 69 / 67 : 71 / 69 / 67	71 / 69 / 67 : 71 / 69 / 67	73 / 71 / 69 : 73 / 71 / 69	73 / 71 / 69 : 73 / 71 / 69	
Number of fan speeds		3	3	3	3	3	3	3	3	3	
Drain piping	mm	VP-25	VP-25	VP-25</							

Indoor Unit

High Static Pressure

Splittable Ducted

High static and large airflow ducted for exceptional installation flexibility.

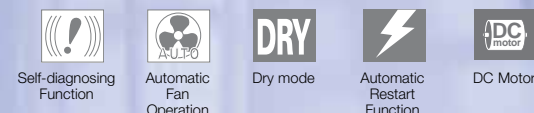

S-180PE3R5B
S-200PE3R5B
S-224PE3R5B



Note: Product image not to scale.

Technical focus

- Easy installation with splittable chassis design
- Max. 200Pa static pressure setting*1
- Design flexibility thanks to high static pressure and large air volume
- DC motor equipped
- Low power input
- Accurate temperature control to reduce cold drafts during operation
- Configurable air temperature control

*1 In case of S-224PE3R5B

Easy Installation with Light Component

Compared to conventional models, the new Panasonic splittable ducted weighs in at approximately 10%*2 lighter. This notion is further emphasised by the unit's ability to split into three components, the heaviest of which totals at 48kg.

*2 Comparison between S-180PE3R5B and S-180PE2R5B



Dimensions of Each Component

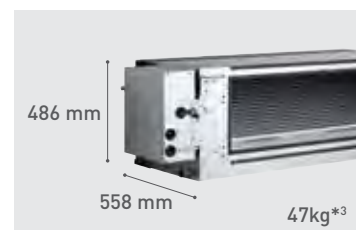

Heat Exchanger

*3 The weight is for the 18.0kW model. (20.0/22.4kW : 48kg)

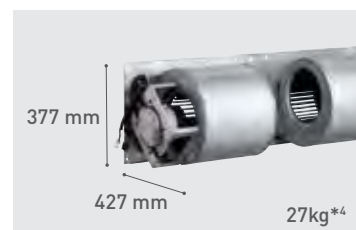

Fan

*4 The weight is for the 18.0/20.0kW model. (22.4kW : 29kg)

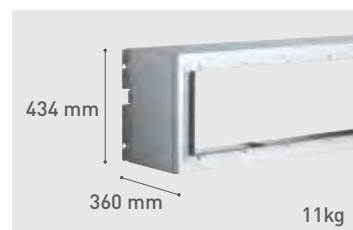

Fan Casing

Specifications of R32 Deluxe Model

Capacity		18.0kW	20.0kW	22.4kW	
Model Name	Indoor Unit / Outdoor Unit	S-180PE3R5B / U-180PZH2R8	S-200PE3R5B / U-200PZH2R8	S-224PE3R5B / U-224PZH2R8	
Cooling capacity	kW	18.0 (5.5-20.0)	20.0 (5.7-22.4)	22.4 (5.7-25.0)	
Heating capacity	BTU/h	61,400 (18,800-68,200) 68,200 (18,800-76,400)	60,000 (19,400-76,400) 76,400 (17,100-85,300)	76,400 (19,400-85,300) 85,300 (16,700-95,500)	
EER : COP	W/W	3.20 : 3.75	3.33 : 3.67	3.09 : 3.52	
COP@H2 condition	W/W	2.90	2.70	2.60	
Total power input	Cooling : Heating kW	5.63 : 5.33	6.00 : 6.10	7.24 : 7.10	
	Hot Climate	4.35 : 5.00	4.33 : 4.35	3.99 : 4.53	
TCSPF : HSPF	Residential	Average Climate	3.92 : 4.27	3.96 : 3.87	3.67 : 3.86
		Cold Climate	4.02 : 3.74	4.03 : 3.43	3.76 : 3.38
	Commercial	Hot Climate	4.75 : 5.03	4.64 : 4.35	4.27 : 4.65
		Average Climate	4.77 : 4.62	4.72 : 4.08	4.30 : 4.27
	Cold Climate	5.11 : 4.12	5.00 : 3.70	4.56 : 3.77	
Indoor Unit					
Power source	Phase/Hz V	1 Phase / 50Hz 230V 240V	1 Phase / 50Hz 230V 240V	1 Phase / 50Hz 230V 240V	
Current (rated)	Cooling : Heating A	3.10 : 3.10 3.00 : 3.00	3.30 : 3.30 3.20 : 3.20	4.20 : 4.20 4.10 : 4.10	
Dimensions	H x W x D mm	486 x 1,456 x 916	486 x 1,456 x 916	486 x 1,456 x 916	
Heat exchanger	H x W x D mm	486 x 1,456 x 558	486 x 1,456 x 558	486 x 1,456 x 558	
Fan	H x W x D mm	377 x 1,150 x 427	377 x 1,150 x 427	377 x 1,150 x 427	
Case	H x W x D mm	434 x 1,178 x 360	434 x 1,178 x 360	434 x 1,178 x 360	
Net weight	kg	85	86	88	
Air volume	Cooling : Heating L/s	1,200 / 1,050 / 883 1,200 / 1,050 / 883	1,200 / 1,050 / 883 1,200 / 1,050 / 883	1,400 / 1,200 / 983 1,400 / 1,200 / 983	
External static pressure	Pa	60 (60 - 150)	75 (75 - 180)	75 (75 - 200)	
Sound pressure level (H/M/L)	Cooling : Heating dB(A)	46 / 44 / 41 : 46 / 44 / 41	46 / 44 / 41 : 46 / 44 / 41	47 / 45 / 42 : 47 / 45 / 42	
Sound power level (H/M/L)	Cooling : Heating dB(A)	78 / 76 / 73 : 78 / 76 / 73	78 / 76 / 73 : 78 / 76 / 73	79 / 77 / 74 : 79 / 77 / 74	
Number of fan speeds		3	3	3	
Drain pipe size	mm	VP-25	VP-25	VP-25	
Outdoor Unit					
Power source	Phase/Hz V	3 Phase / 50Hz 400V 415V	3 Phase / 50Hz 400V 415V	3 Phase / 50Hz 400V 415V	
Current (rated)	Cooling : Heating A	8.00 : 7.55 7.70 : 7.25	8.45 : 8.60 8.15 : 8.30	9.95 : 9.75 9.60 : 9.40	
Dimensions	H x W x D mm	1,500 x 980 x 370	1,500 x 980 x 370	1,500 x 980 x 370	
Net weight	kg	115	128	128	
Air volume	Cooling : Heating L/s	2,733 : 2,733	2,667 : 2,667	2,667 : 2,667	
Sound pressure level (Silent mode)	Cooling : Heating dB(A)	58 (56) : 60 (58)	58 (56) : 62 (60)	58 (56) : 62 (60)	
Sound power level (Silent mode)	Cooling : Heating dB(A)	76 (74) : 78 (76)	77 (75) : 81 (79)	77 (75) : 81 (79)	
Piping connections	Liquid / Gas mm	Ø9.52 / Ø19.05*5	Ø12.70 / Ø19.05*5	Ø12.70 / Ø19.05*5	
Pipe length	min. - max. m	5 - 75	5 - 60	5 - 60	
Elevation difference (OU located lower, OU located higher)	m	30, 30	30, 30	30, 30	
Maximum chargeless length	m	30	30	30	
Refrigerant at shipping / Additional gas amount	g	R32 3,400 / 45/60*6 (g/m)	R32 5,200 / 80 (g/m)	R32 5,200 / 80 (g/m)	
Operation ranges	Cooling : Heating °C	-15 to 46 : -20 to 24	-15 to 46 : -20 to 24	-15 to 46 : -20 to 24	

Notes:

- In the case of nanoe X OFF
- In case it is necessary to indicate the air flow volume in (l/s), the value in (m³/min.) shall be multiplied by 16.7 and rounded down the decimal point.
- AER and ACOP classification is at 230V(400V) only in accordance with GEMS2019.
- TCSPF, HSPF and Total Energy consumption indicate the value of average temperature zone.
- Indoor and outdoor sound levels are determined in an anechoic chamber and may differ once the unit is installed due to ambient conditions
- *5 Tubing size is Ø25.40 when the piping length is over 50m for U-180PZH2R8 and 30m for U-200PZH2R8 and U-224PZH2R8.
- Also, joint needs to be prepared by the site for U-180PZH2R8 when the piping length is over 50m. Please refer to technical documents for more details.
- *6 Additional gas amount is 45g/m when the piping length is under 50m and 60g/m when the piping length is over 50m.

Indoor Unit

High Static Pressure Adaptive Ducted

Control all aspects of your environment with exceptional performance and quiet operation. Vertical installation flexibility offers the perfect solution when ceiling heights are restricted.

nanoe™ X
nanoe™ X as a standard*
*nanoe X Generator Mark 2

ECONAVI
ECONAVI ready



Technical focus

- Space saving 250mm height
- DC fan motor for variable external static pressure control
- Easy to install and maintain
- Accurate temperature control to reduce cold drafts during operation
- Configurable air temperature control

Variable external static pressure control
Optimal airflow set-up is possible for different ducting design and conditions.

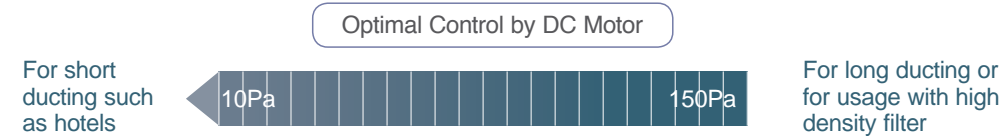

Note: Please refer to technical documents for detail.

Powerful 150Pa external static pressure in an industry-leading vertical installation design

Delivering static pressure up to 150Pa external static pressure, the industry-leading horizontal/vertical design offers the power you need in a compact form factor.

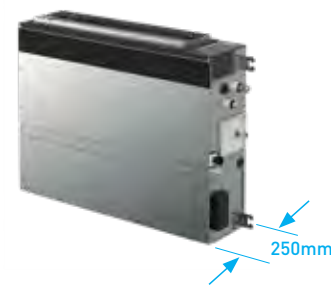

Selectable air inlet position

A removable panel allows air inlet position to be adjusted to enable rear or bottom entry, depending on ductwork installation.

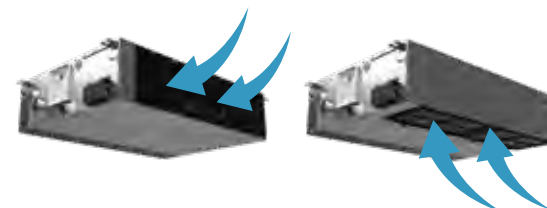

Built-in Drain pump (DC motor pump) External electrical equipment box makes maintenance easy

Space saving height of 250mm for all models

250mm standardised height provides easy and uniform installation for models with different capacities, especially when ceiling heights are restricted.

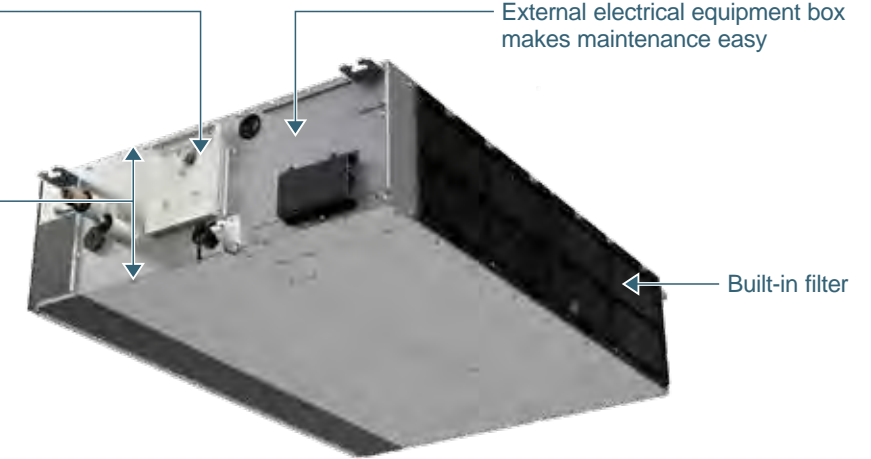

Discharge air temperature control

- Possible to control discharge air temperature for accurate room temperature control.
- Possible to reduce cold drafts during heating operation.

Note: Before spec-in, please consult with an authorised Panasonic dealer.

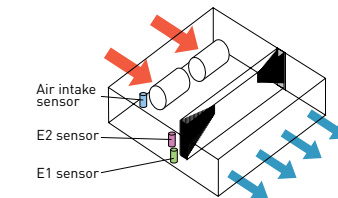

System example

An inspection port (450 mm x 450 mm or larger) is required at the lower side of the indoor unit body.

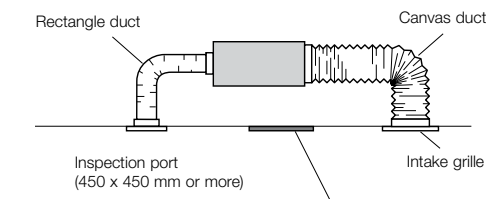

More powerful drain pump

Using a high-lift built-in drain pump, drain piping can be elevated up to 701 mm from the base of the unit.

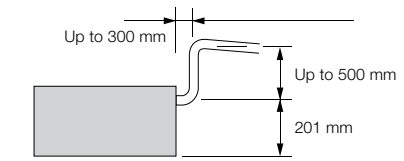

Indoor Unit: High Static Pressure Adaptive Ducted

Specifications of R32 Deluxe Model R32

Capacity		6.8kW		9.5kW		12.1kW		13.4kW	
Model Name	Indoor Unit / Outdoor Unit	S-6071PF3E / U-71PZH3R5	S-1014PF3E / U-100PZH3R5	S-1014PF3E / U-100PZH3R8	S-1014PF3E / U-125PZH3R5	S-1014PF3E / U-125PZH3R8	S-1014PF3E / U-140PZH3R5	S-1014PF3E / U-140PZH3R8	
Cooling capacity : Heating capacity	kW	6.8 (2.2 - 7.8) 7.5 (2.0 - 9.0)	9.5 (3.1 - 11.4) 10.8 (3.1 - 13.5)	9.5 (3.1 - 11.4) 10.8 (3.1 - 13.5)	12.1 (3.2 - 13.6) 13.5 (3.2 - 15.4)	12.1 (3.2 - 13.6) 13.5 (3.2 - 15.4)	13.4 (3.3 - 15.3) 15.5 (3.3 - 17.4)	13.4 (3.3 - 15.3) 15.5 (3.3 - 17.4)	
	BTU/h	23,200 (7,500 - 26,600) 25,600 (6,800 - 30,700)	32,400 (10,600 - 38,900) 36,800 (10,600 - 46,100)	32,400 (10,600 - 38,900) 36,800 (10,600 - 46,100)	41,300 (10,900 - 46,400) 46,100 (10,900 - 52,500)	41,300 (10,900 - 46,400) 46,100 (10,900 - 52,500)	45,700 (11,300 - 52,200) 52,900 (11,300 - 59,400)	45,700 (11,300 - 52,200) 52,900 (11,300 - 59,400)	
EER : COP	W/W	3.74 : 4.03	4.17 : 3.97	4.17 : 3.97	3.58 : 3.46	3.58 : 3.46	3.38 : 3.44	3.38 : 3.44	
COP@H2 condition	W/W	2.96	2.90	2.90	2.60	2.60	2.68	2.68	
Total power input	Cooling : Heating	1.82 : 1.86	2.28 : 2.72	2.28 : 2.72	3.38 : 3.90	3.38 : 3.90	3.96 : 4.51	3.96 : 4.51	
	Hot Climate	5.40 : 5.49	5.93 : 5.57	5.93 : 5.57	5.37 : 5.32	5.37 : 5.32	4.98 : 4.97	4.98 : 4.97	
TCSPF : HSPF	Residential	Average Climate	4.75 : 4.67	5.21 : 4.70	5.21 : 4.70	4.86 : 4.32	4.86 : 4.32	4.55 : 4.15	4.55 : 4.15
		Cold Climate	4.82 : 4.13	5.29 : 4.21	5.29 : 4.21	5.03 : 3.79	5.03 : 3.79	4.72 : 3.65	4.72 : 3.65
	Commercial	Hot Climate	6.02 : 5.54	6.59 : 5.61	6.59 : 5.61	5.95 : 5.44	5.95 : 5.44	5.49 : 5.05	5.49 : 5.05
		Average Climate	6.25 : 5.08	6.75 : 5.13	6.75 : 5.13	6.30 : 4.87	6.30 : 4.87	5.74 : 4.58	5.74 : 4.58
Cold Climate	6.76 : 4.56	7.28 : 4.65	7.28 : 4.65	6.88 : 4.31	6.88 : 4.31	6.25 : 4.08	6.25 : 4.08		
Indoor Unit									
Power source	Phase/Hz	1 Phase / 50Hz	1 Phase / 50Hz	1 Phase / 50Hz	1 Phase / 50Hz	1 Phase / 50Hz	1 Phase / 50Hz	1 Phase / 50Hz	
	V	230V 240V	230V 240V	230V 240V	230V 240V	230V 240V	230V 240V	230V 240V	
Dimension	H x W x D	Indoor	mm	250 x 1,000 x 730	250 x 1,400 x 730	250 x 1,400 x 730	250 X 1,400 X 730	250 X 1,400 X 730	
Net weight	Indoor	kg	30	39	39	39	39	39	
Air volume (H/M/L)	Cooling : Heating	L/s	350 / 317 / 250 : 350 / 317 / 250	534 / 434 / 350 : 534 / 434 / 350	534 / 434 / 350 : 534 / 434 / 350	567 / 484 / 384 : 567 / 484 / 384	601 / 534 / 417 : 601 / 534 / 417	601 / 534 / 417 : 601 / 534 / 417	
External static pressure	Pa	30 (10 - 150)	40 (10 - 150)	40 (10 - 150)	50 (10 - 150)	50 (10 - 150)	50 (10 - 150)	50 (10 - 150)	
Sound pressure level (H/M/L)	Cooling : Heating	dB(A)	30 / 26 / 23 : 30 / 26 / 23	33 / 29 / 25 : 33 / 29 / 25	33 / 29 / 25 : 33 / 29 / 25	35 / 31 / 27 : 35 / 31 / 27	39 / 35 / 29 : 39 / 35 / 29	39 / 35 / 29 : 39 / 35 / 29	
Sound power level (H/M/L)	Cooling : Heating	dB	53 / 49 / 46 : 53 / 49 / 46	56 / 52 / 48 : 56 / 52 / 48	56 / 52 / 48 : 56 / 52 / 48	58 / 54 / 50 : 58 / 54 / 50	62 / 58 / 52 : 62 / 58 / 52	62 / 58 / 52 : 62 / 58 / 52	
Number of fan speeds			5	5	5	5	5	5	
Drain piping	mm	VP-20	VP-20	VP-20	VP-20	VP-20	VP-20	VP-20	
Outdoor Unit									
Power source	Phase/Hz	1 Phase / 50Hz	1 Phase / 50Hz	3 Phase / 50Hz	1 Phase / 50Hz	3 Phase / 50Hz	1 Phase / 50Hz	3 Phase / 50Hz	
	V	230V 240V	230V 240V	400V 415V	230V 240V	400V 415V	230V 240V	400V 415V	
Current (rated)	Cooling : Heating	A	8.60 : 8.60 8.25 : 8.35	10.8 : 12.7 10.3 : 12.2	3.60 : 4.30 3.50 : 4.15	15.8 : 18.2 15.1 : 17.5	5.30 : 6.10 5.15 : 5.90	18.7 : 21.1 17.9 : 20.2	6.30 : 7.15 6.05 : 6.90
Dimensions	H x W x D	mm	996 x 940 x 340	1,416 x 940 x 340	1,416 x 940 x 340	1,416 x 940 x 340	1,416 x 940 x 340	1,416 x 940 x 340	
Net weight	kg	66	99	99	99	99	99	99	
Air volume	Cooling : Heating	L/s	1,018 : 1,002	1,970 : 1,803	1,970 : 1,803	2,087 : 1,870	2,154 : 1,937	2,154 : 1,937	
Sound pressure level (Silent mode)	Cooling : Heating	dB(A)	48 (46) : 50 (48)	52 (50) : 52 (50)	52 (50) : 52 (50)	53 (51) : 53 (51)	54 (52) : 54 (52)	54 (52) : 54 (52)	
Sound power level (Silent mode)	Cooling : Heating	dB	64 (62) : 66 (64)	68 (66) : 68 (66)	68 (66) : 68 (66)	69 (67) : 69 (67)	70 (68) : 70 (68)	70 (68) : 70 (68)	
Piping connections	Liquid / Gas	mm	Ø9.52 / Ø15.88	Ø9.52 / Ø15.88	Ø9.52 / Ø15.88	Ø9.52 / Ø15.88	Ø9.52 / Ø15.88	Ø9.52 / Ø15.88	
Pipe length range	min. - max.	m	5 - 50	5 - 85	5 - 85	5 - 85	5 - 85	5 - 85	
Elevation difference (OU located lower, OU located higher)	m	15, 30	15, 30	15, 30	15, 30	15, 30	15, 30	15, 30	
Maximum chargeless length	m	30	30	30	30	30	30	30	
Refrigerant at shipping / Additional gas amount	g	R32 1,950 / 45 (g/m)	R32 3,050 / 45 (g/m)	R32 3,050 / 45 (g/m)	R32 3,050 / 45 (g/m)	R32 3,050 / 45 (g/m)	R32 3,050 / 45 (g/m)	R32 3,050 / 45 (g/m)	
Operation ranges	Cooling : Heating	°C	-15 to 48 : -20 to 24	-15 to 48 : -20 to 24	-15 to 48 : -20 to 24	-15 to 48 : -20 to 24	-15 to 48 : -20 to 24	-15 to 48 : -20 to 24	

Notes:

- In the case of standard installation (Horizontal installation in the ceiling, rear side air intake)
- In the case of nance X OFF
- In case it is necessary to indicate the air flow volume in (l/s), the value in (m³/min.) shall be multiplied by 16.7 and rounded down the decimal point.
- AEER and A COP classification is at 230V(400V) only in accordance with GEMS2019.
- TCSPF, HSPF and Total Energy consumption indicate the value of average temperature zone.
- Indoor and outdoor sound levels are determined in an anechoic chamber and may differ once the unit is installed due to ambient conditions
- H : High at setting 5 stage (Level 5), M : Middle at setting 5 stage (Level 3), L : Low at setting 5 stage (Level 1) Noise of L is indicated by the values at FAN mode.
- *1 For piping connection for 6.0kW unit, connect the gas socket tube (Ø12.7-Ø15.88) to the gas tubing side indoor unit and connect the liquid socket tube (Ø6.35-Ø9.52) to the liquid tubing side indoor unit.
- *2 For piping connection for 7.1kW unit, connect the liquid socket tube (Ø6.35-Ø9.52) to the liquid tubing side indoor unit.

Specifications of R32 Compact Model R32

Capacity		3.4kW		4.6kW		5.7kW		6.8kW		9.5kW		12.1kW		13.4kW	
Model Name	Indoor Unit / Outdoor Unit	S-3650PF3E / U-36PZ3R5	S-3650PF3E / U-50PZ3R5	S-6071PF3E / U-60PZ3R5	S-6071PF3E / U-71PZ3R5	S-1014PF3E / U-100PZ3R5	S-1014PF3E / U-100PZ3R8	S-1014PF3E / U-125PZ3R5	S-1014PF3E / U-125PZ3R8	S-1014PF3E / U-125PZ3R5	S-1014PF3E / U-125PZ3R8	S-1014PF3E / U-140PZ3R5	S-1014PF3E / U-140PZ3R8		
Cooling capacity : Heating capacity	kW	3.4 (1.3 - 4.0) 3.6 (1.3 - 4.6)	4.6 (1.5 - 5.3) 5.0 (1.5 - 5.9)	5.7 (1.8 - 7.0) 5.7 (1.8 - 7.0)	6.8 (2.1 - 8.1) 6.8 (2.1 - 8.1)	9.5 (3.0 - 11.4) 9.5 (3.0 - 13.5)	9.5 (3.0 - 11.4) 9.5 (3.0 - 13.5)	12.1 (3.2 - 13.5) 12.1 (3.3 - 15.0)	12.1 (3.2 - 13.5) 12.1 (3.3 - 15.0)	13.4 (3.3 - 15.3) 13.4 (3.4 - 16.0)	13.4 (3.3 - 15.3) 13.4 (3.4 - 16.0)	13.4 (3.3 - 15.3) 13.4 (3.4 - 16.0)	13.4 (3.3 - 15.3) 13.4 (3.4 - 16.0)		
	BTU/h	11,600 (4,400 - 13,600) 12,300 (4,400 - 15,700)	15,700 (5,100 - 18,100) 17,100 (5,100 - 20,100)	19,400 (6,800 - 21,500) 19,400 (6,800 - 23,900)	23,200 (8,900 - 26,300) 23,200 (8,900 - 27,600)	32,400 (10,200 - 38,900) 32,400 (10,200 - 46,100)	32,400 (10,200 - 38,900) 32,400 (10,200 - 46,100)	41,300 (10,900 - 46,100) 41,300 (11,300 - 51,200)	41,300 (10,900 - 46,100) 41,300 (11,300 - 51,200)	45,700 (11,300 - 51,200) 45,700 (11,600 - 54,600)	45,700 (11,300 - 51,200) 45,700 (11,600 - 54,600)	45,700 (11,300 - 51,200) 45,700 (11,600 - 54,600)	45,700 (11,300 - 51,200) 45,700 (11,600 - 54,600)		
EER : COP	W/W	3.78 : 4.29	3.19 : 3.62	3.54 : 4.04	3.18 : 4.00	3.57 : 4.09	3.57 : 4.09	3.40 : 3.56	3.40 : 3.56	3.16 : 3.76	3.16 : 3.76	3.16 : 3.76	3.16 : 3.76		
COP@H2 condition	W/W	3.09	3.33	3.09	2.84	2.88	2.88	2.82	2.82	2.73	2.73	2.73	2.73		
Total power input	Cooling : Heating	0.900 : 0.840	1.44 : 1.38	1.61 : 1.41	2.14 : 1.70	2.66 : 2.32	2.66 : 2.32	3.56 : 3.40	3.56 : 3.40	4.24 : 3.56	4.24 : 3.56	4.24 : 3.56	4.24 : 3.56		
	Hot Climate	5.11 : 5.05	4.67 : 5.09	5.19 : 5.76	4.57 : 5.26	5.24 : 5.04	5.24 : 5.04	4.90 : 5.01	4.90 : 5.01	4.75 : 4.93	4.75 : 4.93	4.75 : 4.93	4.75 : 4.93		
TCSPF : HSPF	Residential	Average Climate	4.36 : 4.57	4.23 : 4.31	4.67 : 4.83	4.23 : 4.42	4.52 : 4.52	4.42 : 4.21	4.42 : 4.21	4.33 : 4.18	4.33 : 4.18	4.33 : 4.18	4.33 : 4.18		
		Cold Climate	4.36 : 4.06	4.29 : 3.79	4.82 : 4.13	4.34 : 3.82	4.62 : 4.06	4.62 : 4.06	4.52 : 3.68	4.52 : 3.68	4.47 : 3.63	4.47 : 3.63	4.47 : 3.63		
	Commercial	Hot Climate	5.77 : 5.01	5.22 : 5.13	5.69 : 5.77	5.01 : 5.33	5.87 : 4.99	5.87 : 4.99	5.40 : 5.06	5.40 : 5.06	5.26 : 5.01	5.26 : 5.01	5.26 : 5.01		
		Average Climate	5.84 : 4.72	5.96 : 4.69	6.00 : 5.23	5.53 : 4.86	5.91 : 4.68	5.91 : 4.68	5.81 : 4.60	5.81 : 4.60	5.78 : 4.59	5.78 : 4.59	5.78 : 4.59		
Cold Climate	6.41 : 4.31	6.69 : 4.19	6.54 : 4.60	6.11 : 4.27	6.49 : 4.31	6.49 : 4.31	6.36 : 4.10	6.36 : 4.10	6.40 : 4.05	6.40 : 4.05	6.40 : 4.05	6.40 : 4.05			
Indoor Unit															
Power source	Phase/Hz	1 Phase / 50Hz	1 Phase / 50Hz	1 Phase / 50Hz	1 Phase / 50Hz	1 Phase / 50Hz	1 Phase / 50Hz	1 Phase / 50Hz	1 Phase / 50Hz	1 Phase / 50Hz	1 Phase / 50Hz	1 Phase / 50Hz	1 Phase / 50Hz		
	V	230V 240V	230V 240V	230V 240V	230V 240V	230V 240V	230V 240V	230V 240V	230V 240V	230V 240V	230V 240V	230V 240V	230V 240V		
Dimensions	H x W x D	Indoor	mm	250 x 800 x 730	250 x 800 x 730	250 x 1,000 x 730	250 x 1,000 x 730	250 x 1,400 x 730	250 x 1,400 x 730	250 x 1,400 x 730	250 x 1,400 x 730	250 x 1,400 x 730	250 x 1,400 x 730		
Net weight	Indoor	kg	25	25	30	30	30	39	39	39	39	39			
Air volume (H/M/L)	Cooling : Heating	L/s	233 / 217 / 167 : 233 / 217 / 167	267 / 250 / 200 : 267 / 250 / 200	350 / 317 / 250 : 350 / 317 / 250	350 / 317 / 250 : 350 / 317 / 250	534 / 434 / 350 : 534 / 434 / 350	534 / 434 / 350 : 534 / 434 / 350	567 / 484 / 384 : 567 / 484 / 384	567 / 484 / 384 : 567 / 484 / 384	601 / 534 / 417 : 601 / 534 / 417	601 / 534 / 417 : 601 / 534 / 417			
External static pressure	Pa	30 (10 - 150)	30 (10 - 150)	30 (10 - 150)	30 (10 - 150)	40 (10 - 150)	40 (10 - 150)	50 (10 - 150)	50 (10 - 150)	50 (10 - 150)	50 (10 - 150)				
Sound pressure level (H/M/L)	Cooling : Heating	dB(A)	30 / 27 / 22 : 30 / 27 / 22	34 / 30 / 25 : 34 / 30 / 25	30 / 27 / 22 : 30 / 26 / 23	30 / 27 / 22 : 30 / 26 / 23	33 / 29 / 25 : 33 / 29 / 25	33 / 29 / 25 : 33 / 29 / 25	35 / 31 / 27 : 35 / 31 / 27	39 / 35 / 29 : 39 / 35 / 29	39 / 35 / 29 : 39 / 35 / 29				
Sound power level (H/M/L)	Cooling : Heating	dB	53 / 50 / 45 : 53 / 50 / 45	57 / 53 / 48 : 57 / 53 / 48	53 / 49 / 46 : 53 / 49 / 46	53 / 49 / 46 : 53 / 49 / 46	56 / 52 / 48 : 56 / 52 / 48	56 / 52 / 48 : 56 / 52 / 48	58 / 54 / 50 : 58 / 54 / 50	62 / 58 / 52 : 62 / 58 / 52	62 / 58 / 52 : 62 / 58 / 52				
Number of fan speeds			5	5	5	5	5	5	5	5	5				
Drain piping	mm	VP-20	VP-20	VP-20	VP-20	VP-20	VP-20	VP-20	VP-20	VP-20	VP-20				
Outdoor Unit															
Power source	Phase/Hz	1 Phase / 50Hz	1 Phase / 50Hz	1 Phase / 50Hz	1 Phase / 50Hz	1 Phase / 50Hz	3 Phase / 50Hz	1 Phase / 50Hz	3 Phase / 50Hz	1 Phase / 50Hz	3 Phase / 50Hz	1 Phase / 50Hz	3 Phase / 50Hz		
	V	230V 240V	230V 240V	230V 240V	230V 240V	230V 240V	400V 415V	230V 240V	400V 415V	230V 240V	400V 415V	230V 240V	400V 415V		
Current (rated)	Cooling : Heating	A	4.00 : 3.80 3.85 : 3.55	6.40 : 6.20 6.10 : 5.95	7.15 : 6.25 6.85 : 6.00	9.50 : 7.55 9.10 : 7.25	12.7 : 11.1 12.2 :								

Indoor Unit Ultra Slim Ducted

With a height of only 200 mm, it provides greater flexibility and adaptability for various applications. In addition, high efficiency and extreme low noise level make it highly suitable for apartments and hotels.



CS-Z25UD3RAW
CS-Z35UD3RAW
CS-Z50UD3RAW
CS-Z60UD3RAW



Wired remote controller included.



CZ-TACG1*1

Note: Product image not to scale.

- 
Self-diagnosing Function
- 
Automatic Fan Operation
- 
Dry mode
- 
Automatic Restart Function
- 
Built-in Drain Pump
- 
DC Motor

Technical focus

- Space saving 200mm height
- Easy maintenance and service by external electrical box
- Rear or Bottom Return Air Options
- 40 Pa static pressure enables ductwork to be fitted.
- Built-in Drain Pump
- DC fan motor greatly reduces power consumption

Ultra-slim profile for all models

200mm height for all models allows installation in very narrow ceilings.



Drain pump with increased power

Using the built-in high-lift drain pump, the drain piping rise height can be increased to 653 mm from the lower surface of the body.

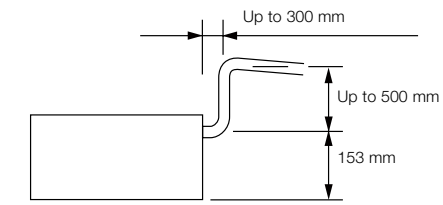

Specifications

Capacity		2.5KW	3.6KW	5.0KW	6.0KW
model Name	Indoor Unit	CS-Z25UD3RAW	CS-Z35UD3RAW	CS-Z50UD3RAW	CS-Z60UD3RAW
	Outdoor Unit	CU-Z25UBRA	CU-Z35UBRA	CU-Z50UBRA	CU-Z60UBRA
Cooling capacity :	kW	2.60 (0.85 - 3.20)	3.70 (0.85 - 4.00)	5.00 (0.90 - 5.70)	5.60 (0.90 - 6.50)
	Heating capacity	3.30 (0.85 - 4.90)	4.20 (0.85 - 5.60)	6.10 (0.90 - 7.20)	7.00 (0.90 - 8.00)
EER : COP	BTU/h	8,870 (2,900 - 10,900)	12,600 (2,900 - 13,600)	17,100 (3,070 - 19,400)	19,100 (3,070 - 22,200)
	W/W	11,300 (2,900 - 16,700)	14,300 (2,900 - 19,100)	20,800 (3,070 - 24,600)	23,900 (3,070 - 27,300)
Power input (min - max)	Cooling : Heating	4.48 : 4.23	3.85 : 4.08	3.57 : 3.63	3.29 : 3.24
	W/W	0.58 (0.24 - 0.85) : 0.78 (0.23 - 1.25)	0.96 (0.24 - 1.12) : 1.03 (0.23 - 1.57)	1.40 (0.26 - 1.78) : 1.68 (0.26 - 2.20)	1.70 (0.26 - 2.30) : 2.16 (0.26 - 2.60)
Indoor Unit					
Power source	Phase/Hz	1 Phase / 50Hz	1 Phase / 50Hz	1 Phase / 50Hz	1 Phase / 50Hz
	V	230V 240V	230V 240V	230V 240V	230V 240V
Dimensions	H x W x D	200 x 750 x 640	200 x 750 x 640	200 x 750 x 640	200 x 750 x 640
Net weight	kg	19	19	19	19
Air volume	Cooling : Heating	175 : 175	187 : 187	255 : 255	262 : 262
	L/s				
Sound pressure level (H/M/L)	Cooling : Heating	33 / 27 / 24 : 34 / 27 / 24	33 / 26 / 23 : 35 / 27 / 24	39 / 29 / 26 : 39 / 30 / 27	41 / 30 / 27 : 41 / 32 / 29
	dB(A)				
Sound power level (H/M/L)	Cooling : Heating	49 / 43 / 40 : 50 / 43 / 40	49 / 42 / 39 : 51 / 43 / 40	55 / 45 / 42 : 55 / 46 / 43	57 / 46 / 43 : 57 / 48 / 45
	dB(A)				
Outdoor Unit					
Power source	Phase/Hz	1 Phase / 50Hz	1 Phase / 50Hz	1 Phase / 50Hz	1 Phase / 50Hz
	V	230V 240V	230V 240V	230V 240V	230V 240V
Current (rated)	Cooling : Heating	2.80 : 3.50 2.70 : 3.40	4.30 : 4.70 4.20 : 4.50	6.30 : 7.40 6.10 : 7.20	7.50 : 9.50 7.30 : 9.30
Dimensions	H x W x D	542 x 780 x 289	619 x 824 x 299	695 x 875 x 320	695 x 875 x 320
Net weight	kg	33	35	42	43
Piping connections	Liquid / Gas	Ø6.35 / Ø9.52	Ø6.35 / Ø9.52	Ø6.35 / Ø12.70	Ø6.35 / Ø12.70
Pipe length	min. - max.	3 - 20	3 - 20	3 - 30	3 - 30
Elevation difference	m	15	15	20	20
Operation ranges	Cooling : Heating	-10 ~ +46 : -15 ~ +24	-10 ~ +46 : -15 ~ +24	-10 ~ +46 : -15 ~ +24	-10 ~ +46 : -15 ~ +24
	°C				

Notes:

The Rated Capacity, Power Input and Running Current are measured in accordance with AS/NZS 3823

- Cooling: Indoor temperature: 27°C DB/ 19°C WB, Outdoor temperature: 35°C DB/ 24°C WB
- Heating: Indoor temperature: 20°C DB/ 15°C WB, Outdoor temperature: 7°C DB/ 6°C WB
- Indoor and outdoor sound levels are determined in an anechoic chamber and may differ once the unit is installed due to ambient conditions
- Sound levels are measured in default status which is rear return air, when changing to bottom return air, sounds levels may be higher.
- Ultra Slim Ducted is not supported by PAC Smart Connectivity+.

*1 If you connect WLAN adaptor (CZ-TACG1) to an indoor unit other than wall mounted type and operate from the smartphone with Panasonic Comfort Cloud App, airflow direction may not be operated as it is shown on the display.

Indoor Unit 4-WAY Cassette

Featuring uniform cooling, easy installation, and with a sleek exterior, this unit is the perfect match for all commercial applications.

nanoe™ X
nanoe™ X as a standard*
*nanoe X Generator Mark 1

ECONAVI
ECONAVI ready

- Self-diagnosing Function
- Automatic Fan Operation
- Dry mode
- Intelligent Auto Swing
- Automatic Restart Function
- Auto Swing (Auto Flap Control)
- Built-in Drain Pump
- DC Motor



Technical focus

- Compact design
- Low sound levels
- DC fan motor for increased efficiency
- Powerful drain pump gives 850 mm lift
- Lightweight design
- Fresh air knockout
- Branch duct connection
- Optional air-intake plenum CZ-FDU3

360° Wide & Comfortable Airflow

Our design features wide-angle outlets and flaps that were designed through expert mechanics and prototype tests. Air from the center is sent farther and the air blown out of the larger, side flaps spreads throughout the room. The air comes from all for sides of the unit and expands gently in a circle centered on the indoor unit.

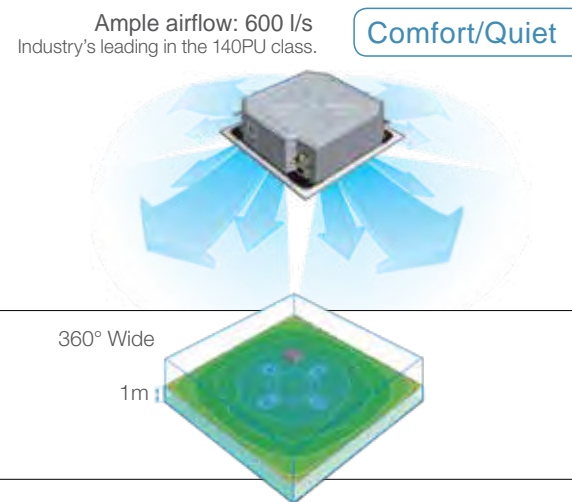

Wide Flap

Adding a sub flap and widening the main flap have reduced turbulence and increased airflow. Also, setting the jetting port at a wider angle allows the airflow to reach the corners of the room more quickly.

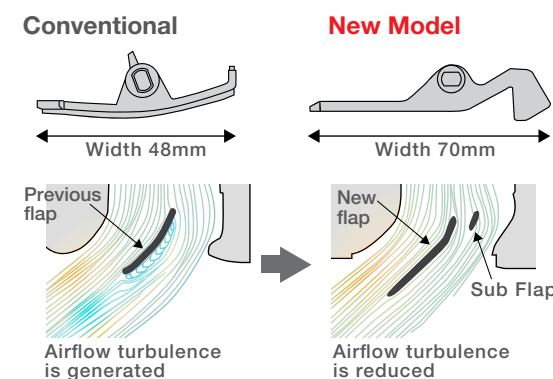

3D Turbo Fan

Using a twisted 3D blade made the unit slimmer and more compact, while also increasing the airflow. A 5-Speed mode allows the airflow to be adjusted in 5 steps to suit the situation.

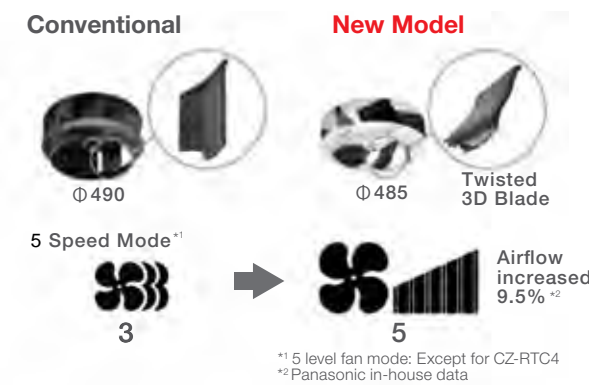

High-Ceiling Installation (Up to 5 m for 10.0kW+ models)

The units can be installed in rooms with high ceilings, where they provide ample floor-level heating in the winter. (See ceiling height guidelines below.)

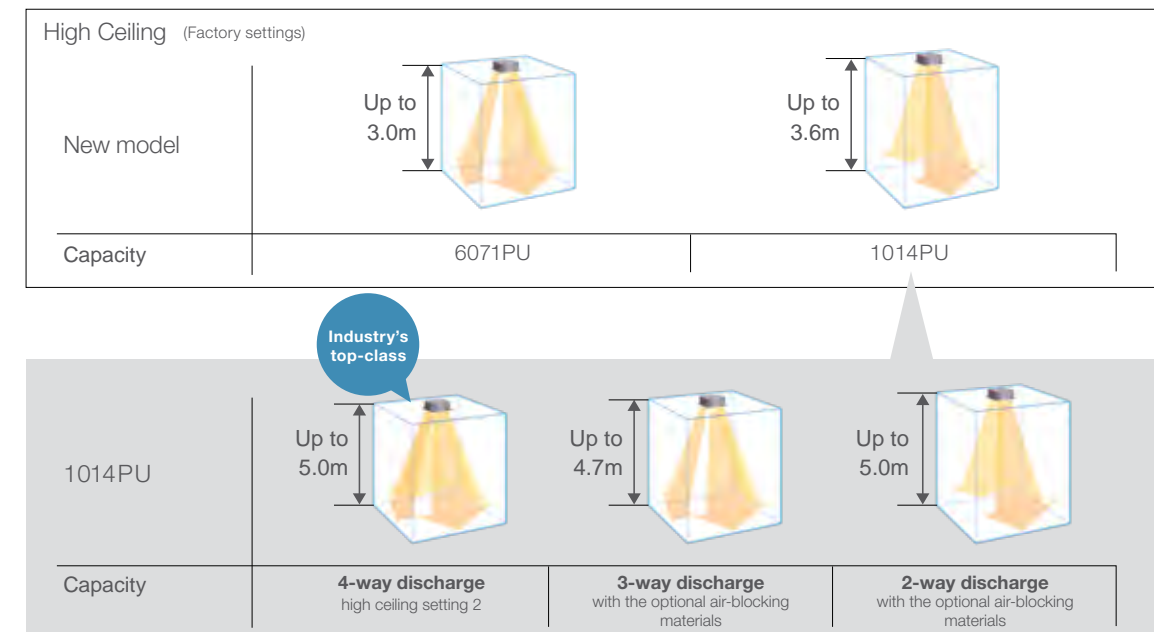

Ceiling height guidelines

Indoor unit	*3 settings 4-way discharge			3-way discharge (optional air-blocking materials)	2-way discharge (optional air-blocking materials) **
	Standard (Factory setting)	High ceiling setting 1	High ceiling setting 2		
6071PU	3.0	3.3	3.6	3.8	4.2
1014PU	3.6	4.3	5.0	4.7	5.0

*3 When using the unit in a configuration other than the factory settings, it is necessary to make settings on site to increase airflow.
** Use air-blocking materials (CZ-CFU3) to completely block two discharge outlets for 2-way airflow.

Indoor Unit: 4-WAY Cassette

Specifications of R32 Deluxe Model



Capacity		7.1kW		10.0kW		12.5kW		14.0kW	
Model Name	Indoor Unit	S-6071PU3E	S-1014PU3E	S-1014PU3E	S-1014PU3E	S-1014PU3E	S-1014PU3E	S-1014PU3E	S-1014PU3E
	Outdoor Unit	U-71PZH3R5	U-100PZH3R5	U-100PZH3R8	U-125PZH3R5	U-125PZH3R8	U-140PZH3R5	U-140PZH3R8	
Panel		Standard type:CZ-KPU3H ECONAVI type:CZ-KPU3A		Standard type:CZ-KPU3H ECONAVI type:CZ-KPU3A		Standard type:CZ-KPU3H ECONAVI type:CZ-KPU3A		Standard type:CZ-KPU3H ECONAVI type:CZ-KPU3A	
Cooling capacity	kW	7.1 (2.2 - 9.0)	10.0 (3.1 - 12.5)	10.0 (3.1 - 12.5)	12.5 (3.2 - 14.0)	12.5 (3.2 - 14.0)	14.0 (3.3 - 16.0)	14.0 (3.3 - 16.0)	
		8.0 (2.0 - 9.0)	11.2 (3.1 - 14.0)	11.2 (3.1 - 14.0)	14.0 (3.2 - 16.0)	14.0 (3.2 - 16.0)	16.0 (3.3 - 18.0)	16.0 (3.3 - 18.0)	
Heating capacity	BTU/h	24,200 (7,500 - 30,700)	34,100 (10,600 - 42,700)	34,100 (10,600 - 42,700)	42,700 (10,900 - 47,800)	42,700 (10,900 - 47,800)	47,800 (11,300 - 54,600)	47,800 (11,300 - 54,600)	
		27,300 (6,800 - 30,700)	38,200 (10,600 - 47,800)	38,200 (10,600 - 47,800)	47,800 (10,900 - 54,600)	47,800 (10,900 - 54,600)	54,600 (11,300 - 61,400)	54,600 (11,300 - 61,400)	
EER : COP	W/W	4.06 : 4.30	4.41 : 5.00	4.41 : 5.00	3.80 : 4.61	3.80 : 4.61	3.41 : 4.30	3.41 : 4.30	
COP@H2 condition	W/W	2.60	2.90	2.90	2.70	2.70	2.50	2.50	
Total power input	kW	Cooling : Heating	1.75 : 1.86	2.27 : 2.24	2.27 : 2.24	3.29 : 3.04	3.29 : 3.04	4.11 : 3.72	4.11 : 3.72
		Hot Climate	5.86 : 5.68	6.24 : 5.68	6.24 : 5.68	5.71 : 5.63	5.71 : 5.63	5.35 : 5.60	5.35 : 5.60
		Average Climate	5.10 : 4.77	5.53 : 5.15	5.53 : 5.15	5.20 : 4.88	5.20 : 4.88	4.93 : 4.71	4.93 : 4.71
		Cold Climate	5.16 : 4.11	5.64 : 4.63	5.64 : 4.63	5.39 : 4.28	5.39 : 4.28	5.17 : 4.01	5.17 : 4.01
		Hot Climate	6.58 : 5.81	6.96 : 5.66	6.96 : 5.66	6.36 : 5.74	6.36 : 5.74	5.96 : 5.76	5.96 : 5.76
		Average Climate	6.83 : 5.30	7.09 : 5.35	7.09 : 5.35	6.72 : 5.32	6.72 : 5.32	6.43 : 5.25	6.43 : 5.25
		Cold Climate	7.41 : 4.63	7.69 : 4.92	7.69 : 4.92	7.37 : 4.72	7.37 : 4.72	7.10 : 4.53	7.10 : 4.53
Indoor Unit		Phase/Hz		1 Phase / 50Hz		1 Phase / 50Hz		1 Phase / 50Hz	
Power source		V		230V 240V		230V 240V		230V 240V	
Dimensions	H x W x D	Indoor	mm	256 x 840 x 840	319 x 840 x 840	319 x 840 x 840	319 x 840 x 840	319 x 840 x 840	
		Panel	mm	33.5 x 950 x 950	33.5 x 950 x 950	33.5 x 950 x 950	33.5 x 950 x 950	33.5 x 950 x 950	
Net weight		kg		20 / 5		25 / 5		25 / 5	
Air volume (H/M/L)		L/s		367 / 267 / 217 : 367 / 267 / 217		601 / 434 / 300 : 601 / 434 / 300		617 / 450 / 317 : 617 / 450 / 317	
Sound pressure level (H/M/L)		dB(A)		37 / 31 / 28 : 37 / 31 / 28		45 / 38 / 32 : 45 / 38 / 32		46 / 39 / 33 : 46 / 39 / 33	
Sound power level (H/M/L)		dB		52 / 46 / 43 : 52 / 46 / 43		60 / 53 / 47 : 60 / 53 / 47		61 / 54 / 48 : 61 / 54 / 48	
Number of fan speeds				5		5		5	
Drain pipe size		mm		VP-25		VP-25		VP-25	
Outdoor Unit		Phase/Hz		1 Phase / 50Hz		3 Phase / 50Hz		1 Phase / 50Hz	
Power source		V		230V 240V		400V 415V		230V 240V	
Current (rated)		Cooling : Heating		A		8.25 : 8.70 7.95 : 8.35		10.7 : 10.6 10.3 : 10.1	
Dimension		H x W x D		mm		996 x 940 x 340		1,416 x 940 x 340	
Net weight		kg		66		99		99	
Air volume		Cooling : Heating		m³/min		1,018 : 1,002		1,970 : 1,803	
Sound pressure level (Silent mode)		Cooling : Heating		dB(A)		48 (46) : 50 (48)		52 (50) : 52 (50)	
Sound power level (Silent mode)		Cooling : Heating		dB		64 (62) : 66 (64)		68 (66) : 68 (66)	
Piping connections		Liquid / Gas		mm		Ø9.52 / Ø15.88		Ø9.52 / Ø15.88	
Pipe length range		min. - max.		m		5 - 50		5 - 85	
Elevation difference (OU located lower, OU located higher)		m		15, 30		15, 30		15, 30	
Maximum chargeless length		m		30		30		30	
Refrigerant at shipping, Additional gas amount		g		R32 1,950 / 45 (g/m)		R32 3,050 / 45 (g/m)		R32 3,050 / 45 (g/m)	
Operating range		Cooling : Heating		°C		-15 to 48 : -20 to 24		-15 to 48 : -20 to 24	

Notes:

- In the case of nanoe X OFF
- In case it is necessary to indicate the air flow volume in (l/s), the value in (m³/min) shall be multiplied by 16.7 and rounded down the decimal point.
- AER and ACOP classification is at 230V(400V) only in accordance with GEMS2019.
- TCSPP, HSPF and Total Energy consumption indicate the value of average temperature zone.
- Indoor and outdoor sound levels are determined in an anechoic chamber and may differ once the unit is installed due to ambient conditions
- H:High at setting 5 stage (Level 5), M:Middle at setting 5 stage (Level 3), L:Low at setting 5 stage (Level 1)

*1 For piping connection for 6.0kW unit, connect the gas socket tube (Ø12.7-Ø15.88) to the gas tubing side indoor unit and connect the liquid socket tube (Ø6.35-Ø9.52) to the liquid tubing side indoor unit.

*2 For piping connection for 7.1kW unit, connect the liquid socket tube (Ø6.35-Ø9.52) to the liquid tubing side indoor unit.

Specifications of R32 Compact Model



Capacity		6.0kW		7.1kW		10.0kW		12.5kW		14.0kW	
Model Name	Indoor Unit	S-6071PU3E	S-1014PU3E	S-1014PU3E	S-1014PU3E	S-1014PU3E	S-1014PU3E	S-1014PU3E	S-1014PU3E	S-1014PU3E	
	Outdoor Unit	U-60PZ3R5	U-71PZ3R5	U-100PZ3R5	U-100PZ3R8	U-125PZ3R5	U-125PZ3R8	U-140PZ3R5	U-140PZ3R8		
Panel		Standard type:CZ-KPU3H ECONAVI type:CZ-KPU3A		Standard type:CZ-KPU3H ECONAVI type:CZ-KPU3A		Standard type:CZ-KPU3H ECONAVI type:CZ-KPU3A		Standard type:CZ-KPU3H ECONAVI type:CZ-KPU3A		Standard type:CZ-KPU3H ECONAVI type:CZ-KPU3A	
Cooling capacity	kW	6.0 (2.0 - 7.1)	7.1 (2.6 - 7.7)	10.0 (3.0 - 11.5)	10.0 (3.0 - 11.5)	12.5 (3.2 - 13.5)	12.5 (3.2 - 13.5)	14.0 (3.3 - 15.0)	14.0 (3.3 - 15.0)		
		6.0 (1.8 - 7.0)	7.1 (2.1 - 8.1)	10.0 (3.0 - 14.0)	10.0 (3.0 - 14.0)	12.5 (3.3 - 15.0)	12.5 (3.3 - 15.0)	14.0 (3.4 - 16.0)	14.0 (3.4 - 16.0)		
Heating capacity	BTU/h	20,500 (6,800 - 24,200)	24,200 (8,900 - 26,300)	34,100 (10,200 - 39,200)	34,100 (10,200 - 39,200)	42,700 (10,900 - 46,100)	42,700 (10,900 - 46,100)	47,800 (11,300 - 51,200)	47,800 (11,300 - 51,200)		
		20,500 (6,100 - 23,900)	24,200 (7,200 - 27,600)	34,100 (10,200 - 47,800)	34,100 (10,200 - 47,800)	42,700 (11,300 - 51,200)	42,700 (11,300 - 51,200)	47,800 (11,600 - 54,600)	47,800 (11,600 - 54,600)		
EER : COP	W/W	3.82 : 4.48	3.40 : 4.23	3.82 : 4.93	3.82 : 4.93	3.58 : 4.43	3.58 : 4.43	3.23 : 4.18	3.23 : 4.18		
COP@H2 condition	W/W	3.19	3.30	3.27	3.27	2.88	2.88	2.70	2.70		
Total power input	kW	Cooling : Heating	1.57 : 1.34	2.09 : 1.68	2.62 : 2.03	2.62 : 2.03	3.49 : 2.82	3.49 : 2.82	4.34 : 3.35	4.34 : 3.35	
		Hot Climate	5.65 : 6.69	5.12 : 5.75	5.78 : 5.43	5.78 : 5.43	5.27 : 5.56	5.27 : 5.56	4.94 : 5.52	4.94 : 5.52	
		Average Climate	5.04 : 5.44	4.84 : 4.85	5.00 : 5.06	5.00 : 5.06	4.73 : 4.87	4.73 : 4.87	4.54 : 4.72	4.54 : 4.72	
		Cold Climate	5.23 : 4.45	4.83 : 4.14	5.10 : 4.62	5.10 : 4.62	4.85 : 4.17	4.85 : 4.17	4.69 : 3.97	4.69 : 3.97	
		Hot Climate	6.17 : 6.71	5.73 : 5.78	6.60 : 5.34	6.60 : 5.34	5.84 : 5.51	5.84 : 5.51	5.46 : 5.51	5.46 : 5.51	
		Average Climate	6.29 : 5.97	6.05 : 5.26	7.05 : 5.11	7.05 : 5.11	6.29 : 5.11	6.29 : 5.11	6.19 : 5.03	6.19 : 5.03	
		Cold Climate	6.75 : 5.06	6.79 : 4.61	7.94 : 4.78	7.94 : 4.78	6.95 : 4.53	6.95 : 4.53	6.89 : 4.40	6.89 : 4.40	
Indoor Unit		Phase/Hz		1 Phase / 50Hz		1 Phase / 50Hz		1 Phase / 50Hz		1 Phase / 50Hz	
Power source		V		230V 240V		230V 240V		230V 240V		230V 240V	
Dimensions	H x W x D	Indoor	mm	256 x 840 x 840	256 x 840 x 840	319 x 840 x 840	319 x 840 x 840	319 x 840 x 840	319 x 840 x 840		
		Panel	mm	33.5 x 950 x 950	33.5 x 950 x 950	33.5 x 950 x 950	33.5 x 950 x 950	33.5 x 950 x 950	33.5 x 950 x 950		
Net weight		kg		20 / 5		25 / 5		25 / 5		25 / 5	
Air volume (H/M/L)		L/s		350 / 267 / 217 : 350 / 267 / 217		367 / 267 / 217 : 367 / 267 / 217		601 / 434 / 300 : 601 / 434 / 300		617 / 450 / 317 : 617 / 450 / 317	
Sound pressure level (H/M/L)		dB(A)		36 / 31 / 28 : 36 / 31 / 28		37 / 31 / 28 : 37 / 31 / 28		45 / 38 / 32 : 45 / 38 / 32		46 / 39 / 33 : 46 / 39 / 33	
Sound power level (H/M/L)		dB		51 / 46 / 43 : 51 / 46 / 43		52 / 46 / 43 : 52 / 46 / 43		60 / 53 / 47 : 60 / 53 / 47		61 / 54 / 48 : 61 / 54 / 48	
Number of fan speeds				5		5		5		5	
Drain pipe size		mm		VP-25		VP-25		VP-25		VP-25	
Outdoor Unit		Phase/Hz		1 Phase / 50Hz		3 Phase / 50Hz		1 Phase / 50Hz		1 Phase / 50Hz	
Power source		V		230V 240V		400V 415V		230V 240V		400V 415V	
Current (rated)		Cooling : Heating		A		7.20 : 5.95 6.90 : 5.70		9.65 : 7.45 9.25 : 7.15		12.5 : 9.70 12.0 : 9.30	
Dimension		H x W x D		mm		695 x 875 x 320		996 x 980 x 370		996 x 980 x 370	
Net weight		kg		43		83		87		87	
Air volume		Cooling : Heating		m³/min		701 : 701		1,219 : 1,219		1,369 : 1,336	
Sound pressure level (Silent mode)		Cooling : Heating		dB(A)		48 (46) : 49 (47)		52 (50) : 52 (50)		55 (53) : 55 (53)	
Sound power level (Silent mode)		Cooling : Heating		dB		66 (64) : 67 (65)		70 (68) : 70 (68)		73 (71) : 73 (71)	
Piping connections		Liquid / Gas		mm		Ø6.35 / Ø12.7**		Ø6.35 / Ø15.88**		Ø9.52 / Ø15.88	
Pipe length range		min. - max.		m		3 - 40		5 - 50		5 - 50	
Elevation difference (OU located lower, OU located higher)		m		15, 30		15, 30		15, 30		15, 30	
Maximum chargeless length		m		30		30		30		30	
Refrigerant at shipping, Additional gas amount		g		R32 1,130 / 15 (g/m)		R32 1,320 / 17 (g/m)		R32 2,400 / 45 (g/m)		R32 2,400 / 45 (g/m)	
Operation ranges		Cooling : Heating		°C		-10 to 46 : -15 to 24		-10 to 46 : -15 to 24		-10 to 46 : -15 to 24	

Indoor Unit 4-WAY Mini Cassette

Designed to fit perfectly into a 60 x 60 cm ceiling grid without the need to alter the bar configuration, 4-WAY Mini Cassette is ideal for small commercial and retrofit applications.

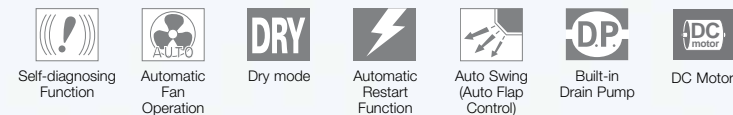

CS-Z25UB4RAW
CS-Z35UB4RAW
CS-Z50UB4RAW
CS-Z60UB4RAW



Panel CZ-BT30EW



Wireless remote controller included.



CZ-RD52CP



CZ-TACG1**

Note: Product image not to scale.

Technical focus

- Market Leading Energy Efficiency
- Compact Design (260mm high)
- Easy Installation
- Built-in Drain Pump
- Mini Cassette fits into a 60 x 60cm ceiling grid
- Powerful drain pump gives 750mm lift
- DC fan motor with variable speed and a new heat exchanger ensures efficient power consumption
- Fresh air knock out
- Multi-directional airflow

Compact design

The panel is a compact (70x70 cm) so it can be installed even in a small room where space is limited.

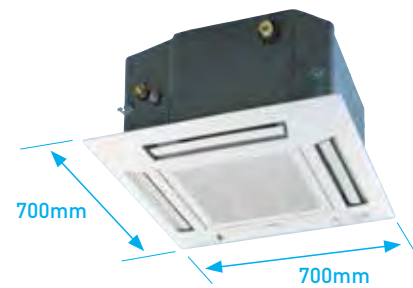

Lighter and slimmer, easier installation

When only 260mm of indoor body height, it can easily fit in limited spaces and tight spots. (Required 288mm from bottom of panel to top of the unit)

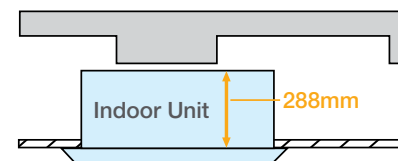

A drain height of up to 750 mm from the ceiling surface

The internal pump allows the drain pipe to be elevated up to 750mm above the base of the unit.

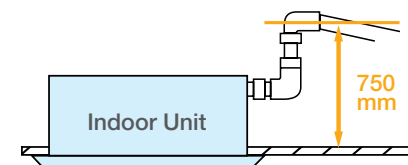

Specifications

Capacity		2.5KW	3.6KW	5.0KW	6.0KW
model Name	Indoor Unit	CS-Z25UB4RAW	CS-Z35UB4RAW	CS-Z50UB4RAW	CS-Z60UB4RAW
	Outdoor Unit	CU-Z25UBRA	CU-Z35UBRA	CU-Z50UBRA	CU-Z60UBRA
Cooling capacity :		2.50 (0.85 - 3.20)	3.50 (0.85 - 4.00)	4.80 (0.90 - 5.70)	5.70 (0.90 - 6.35)
	Heating capacity	3.20 (0.85 - 4.80)	4.00 (0.85 - 5.40)	5.00 (0.90 - 7.10)	6.00 (0.90 - 8.00)
	BTU/h	8,530 (2,900 - 10,900)	11,900 (2,900 - 13,600)	16,400 (3,070 - 19,400)	19,400 (3,070 - 21,700)
		10,900 (2,900 - 16,400)	13,600 (2,900 - 18,400)	17,100 (3,070 - 24,200)	20,500 (3,070 - 27,300)
EER : COP	W/W	4.55 : 4.16	3.89 : 3.92	3.38 : 3.38	3.29 : 3.30
Power input (min - max)	Cooling : Heating	0.55 (0.24 - 0.82) : 0.77 (0.23 - 1.32)	0.90 (0.24 - 1.18) : 1.02 (0.23 - 1.65)	1.42 (0.26 - 1.84) : 1.48 (0.26 - 2.41)	1.73 (0.26 - 2.20) : 1.82 (0.26 - 2.75)
Indoor Unit					
Power source	Phase/Hz	1 Phase/ 50Hz	1 Phase/ 50Hz	1 Phase/ 50Hz	1 Phase/ 50Hz
	V	230V 240V	230V 240V	230V 240V	230V 240V
Dimensions	H x W x D	mm 260 x 575 x 575	mm 260 x 575 x 575	mm 260 x 575 x 575	mm 260 x 575 x 575
Net weight	kg	18	18	18	18
Air volume	Cooling : Heating	L/s 175 : 180	L/s 175 : 195	L/s 192 : 197	L/s 237 : 253
Sound pressure level (H/M/L)	Cooling : Heating	dB(A) 34 / 25 / 22 : 35 / 28 / 25	dB(A) 34 / 26 / 23 : 37 / 28 / 25	dB(A) 38 / 28 / 25 : 39 / 29 / 26	dB(A) 43 / 32 / 29 : 45 / 32 / 29
Sound power level (H/M/L)	Cooling : Heating	dB(A) 50 / 41 / 38 : 51 / 44 / 41	dB(A) 50 / 42 / 39 : 53 / 44 / 41	dB(A) 54 / 44 / 41 : 55 / 45 / 42	dB(A) 59 / 48 / 45 : 61 / 48 / 45
Outdoor Unit					
Power source	Phase/Hz	1 Phase / 50Hz	1 Phase / 50Hz	1 Phase / 50Hz	1 Phase / 50Hz
	V	230V 240V	230V 240V	230V 240V	230V 240V
Current (rated)	Cooling : Heating	A 2.60 : 3.50 2.50 : 3.40	A 4.05 : 4.55 3.95 : 4.35	A 6.30 : 6.50 6.10 : 6.30	A 7.60 : 8.00 7.40 : 7.80
Dimensions	H x W x D	mm 542 x 780 x 289	mm 619 x 824 x 299	mm 695 x 875 x 320	mm 695 x 875 x 320
Net weight	kg	33	35	42	43
Piping connections	Liquid / Gas	mm Ø6.35 / Ø9.52	mm Ø6.35 / Ø9.52	mm Ø6.35 / Ø12.70	mm Ø6.35 / Ø12.70
Pipe length	min. - max.	m 3 - 20	m 3 - 20	m 3 - 30	m 3 - 30
Elevation difference	m	15	15	20	20
Operation ranges	Cooling : Heating	°C -10 ~ +46 : -15 ~ +24	°C -10 ~ +46 : -15 ~ +24	°C -10 ~ +46 : -15 ~ +24	°C -10 ~ +46 : -15 ~ +24

Notes:

The Rated Capacity, Power Input and Running Current are measured in accordance with AS/NZS 3823

• Cooling: Indoor temperature: 27°C DB/ 19°C WB, Outdoor temperature: 35°C DB/ 24°C WB

• Heating: Indoor temperature: 20°C DB/ 15°C WB, Outdoor temperature: 7°C DB/ 6°C WB

• Indoor and outdoor sound levels are determined in an anechoic chamber and may differ once the unit is installed due to ambient conditions

• 4-WAY Mini Cassette is not supported by PAC Smart Connectivity+.

** If you connect WLAN adaptor (CZ-TACG1) to an indoor unit other than wall mounted type and operate from the smartphone with Panasonic Comfort Cloud App, airflow direction may not be operated as it is shown on the display.

Indoor Unit Under Ceiling

Providing outstanding energy-saving performance, comfort and long-distance airflow distribution, these units are perfect for retail stores and schools.

nanoe™ X
nanoe™ X as a standard*
*nanoe X Generator Mark 2

ECONAVI





ECONAVI ready



S-6071PT3E



S-1014PT3E

-  Self-diagnosing Function
-  Automatic Fan Operation
-  Automatic Restart Function
-  DC Motor



CZ-RTC6BL CZ-RTC6BLW CZ-RTC5B CZ-RTC4 CZ-CAPWFC1 CZ-CENSC1
Note: Product image not to scale.

Compact Looking, Stylish, One-Motion Design

With its streamlined, one-motion form, the unit looks thin and compact when installed for a neat appearance in any room. When not operating, the louver closes to provide an elegant look while also keeping the unit clean.



Energy-Saving Technology Delivering Top-Class Efficiency

Optimisation of the shape of the casing and fan assures bigger air flow and higher efficiency. Energy-saving performance is top class in the industry.

Top Class Energy Saving

New DC fan motor



Large Diagonal Air Flow Fan

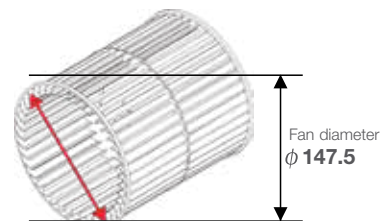

Comfortable, Long-Distance Airflow Distribution

The shape of the outlet has been optimised to provide long-distance air flow distribution. Even in long rooms, air flow reaches every corner for exceptionally comfortable air conditioning.

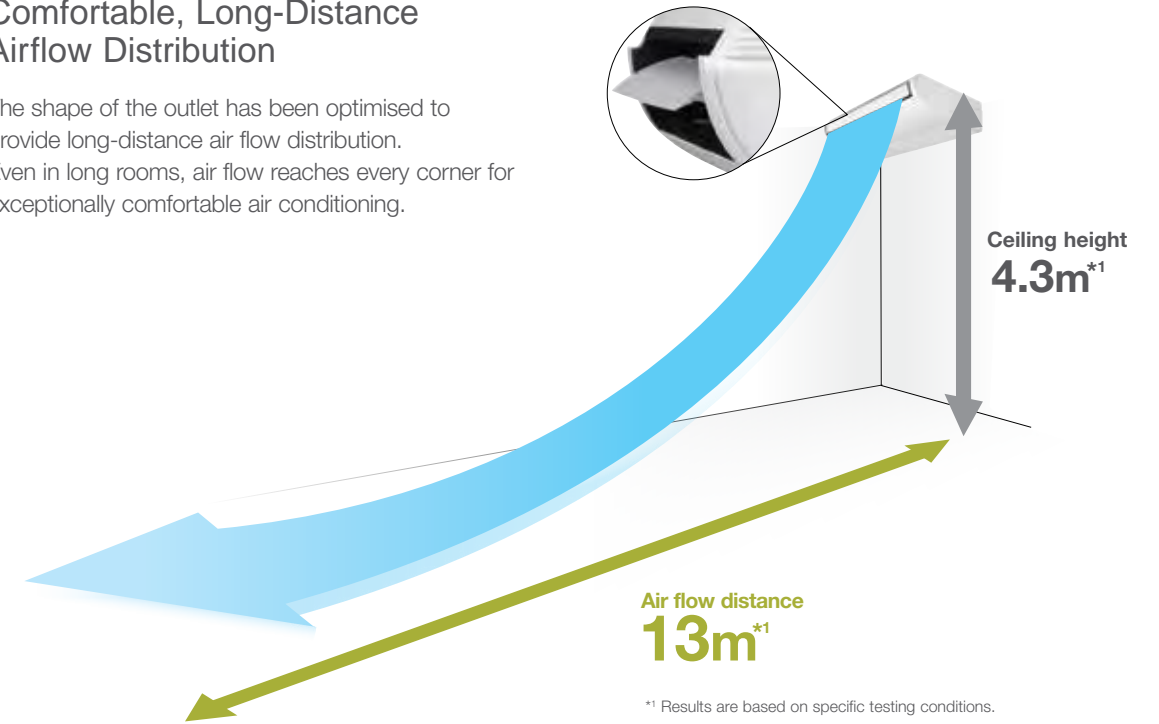

Air flow distance
13m*1

Ceiling height
4.3m*1

*1 Results are based on specific testing conditions.

High Ceiling Setting*2	Air flow distance		
	100	125	140
4.3m	Up to 12m	Up to 13m	Up to 13m

*2 Dedicated fan speed setting required.



Indoor Unit: Under Ceiling

Specifications of R32 Deluxe Model R32

Capacity		6.8kW		9.5kW		12.1kW		13.4kW	
Model Name	Indoor Unit	S-6071PT3E	S-1014PT3E	S-1014PT3E	S-1014PT3E	S-1014PT3E	S-1014PT3E	S-1014PT3E	S-1014PT3E
	Outdoor Unit	U-71PZH3R5	U-100PZH3R5	U-100PZH3R8	U-125PZH3R5	U-125PZH3R8	U-140PZH3R5	U-140PZH3R8	
Cooling capacity : Heating capacity	kW	6.8 (2.2 - 9.0) 8.0 (2.0 - 9.0)	9.5 (3.1 - 12.5) 11.2 (3.1 - 14.0)	9.5 (3.1 - 12.5) 11.2 (3.1 - 14.0)	12.1 (3.2 - 14.0) 14.0 (3.2 - 16.0)	12.1 (3.2 - 14.0) 14.0 (3.2 - 16.0)	13.4 (3.3 - 16.0) 16.0 (3.3 - 18.0)	13.4 (3.3 - 16.0) 16.0 (3.3 - 18.0)	
	BTU/h	23,200 (7,500 - 30,700) 27,300 (6,800 - 30,700)	32,400 (10,600 - 42,700) 38,200 (10,600 - 47,800)	32,400 (10,600 - 42,700) 38,200 (10,600 - 47,800)	41,300 (10,900 - 47,800) 47,800 (10,900 - 54,600)	41,300 (10,900 - 47,800) 47,800 (10,900 - 54,600)	45,700 (11,300 - 54,600) 54,600 (11,300 - 61,400)	45,700 (11,300 - 54,600) 54,600 (11,300 - 61,400)	
EER : COP	W/W	3.91 : 3.96	4.15 : 4.09	4.15 : 4.09	3.51 : 3.78	3.51 : 3.78	3.21 : 3.48	3.21 : 3.48	
COP@H2 condition	W/W	2.60	2.72	2.72	2.52	2.52	2.37	2.37	
Total power input	kW	1.74 : 2.02	2.29 : 2.74	2.29 : 2.74	3.45 : 3.70	3.45 : 3.70	4.17 : 4.60	4.17 : 4.60	
TCSPF : HSPF	Residential	Hot Climate	5.96 : 5.61	6.07 : 5.59	6.07 : 5.59	5.42 : 5.37	5.42 : 5.37	5.07 : 5.26	5.07 : 5.26
		Average Climate	5.13 : 4.63	5.25 : 4.74	5.25 : 4.74	4.85 : 4.44	4.85 : 4.44	4.61 : 4.22	4.61 : 4.22
		Cold Climate	5.24 : 4.00	5.33 : 4.21	5.33 : 4.21	5.03 : 3.84	5.03 : 3.84	4.82 : 3.58	4.82 : 3.58
	Commercial	Hot Climate	6.74 : 5.74	6.84 : 5.66	6.84 : 5.66	6.07 : 5.50	6.07 : 5.50	5.66 : 5.45	5.66 : 5.45
		Average Climate	6.92 : 5.18	6.95 : 5.18	6.95 : 5.18	6.41 : 4.97	6.41 : 4.97	6.10 : 4.83	6.10 : 4.83
		Cold Climate	7.55 : 4.53	7.54 : 4.66	7.54 : 4.66	7.03 : 4.35	7.03 : 4.35	6.71 : 4.13	6.71 : 4.13
Indoor Unit									
Power source	Phase/Hz	1 Phase / 50Hz	1 Phase / 50Hz	1 Phase / 50Hz	1 Phase / 50Hz	1 Phase / 50Hz	1 Phase / 50Hz	1 Phase / 50Hz	
	V	230V 240V	230V 240V	230V 240V	230V 240V	230V 240V	230V 240V	230V 240V	
Dimension	H x W x D	Indoor	mm	235 X 1,275 X 690	235 X 1,590 X 690	235 X 1,590 X 690	235 X 1,590 X 690	235 X 1,590 X 690	235 X 1,590 X 690
Net weight	Indoor	kg	34	40	40	40	40	40	
Air volume (H/M/L)	Cooling : Heating	L/s	350 / 300 / 258 : 350 / 300 / 258	501 / 417 / 384 : 501 / 417 / 384	501 / 417 / 384 : 501 / 417 / 384	567 / 467 / 400 : 567 / 467 / 400	567 / 467 / 400 : 567 / 467 / 400	584 / 484 / 417 : 584 / 484 / 417	584 / 484 / 417 : 584 / 484 / 417
Sound pressure level (H/M/L)	Cooling : Heating	dB(A)	39 / 35 / 30 : 39 / 35 / 30	42 / 37 / 34 : 42 / 37 / 34	42 / 37 / 34 : 42 / 37 / 34	46 / 40 / 35 : 46 / 40 / 35	46 / 40 / 35 : 46 / 40 / 35	47 / 41 / 36 : 47 / 41 / 36	47 / 41 / 36 : 47 / 41 / 36
Sound power level (H/M/L)	Cooling : Heating	dB	57 / 53 / 48 : 57 / 53 / 48	60 / 55 / 52 : 60 / 55 / 52	60 / 55 / 52 : 60 / 55 / 52	64 / 58 / 53 : 64 / 58 / 53	64 / 58 / 53 : 64 / 58 / 53	65 / 59 / 54 : 65 / 59 / 54	65 / 59 / 54 : 65 / 59 / 54
Number of fan speeds			5	5	5	5	5	5	
Drain piping	mm	VP-20	VP-20	VP-20	VP-20	VP-20	VP-20	VP-20	
Outdoor Unit									
Power source	Phase/Hz	1 Phase / 50Hz	1 Phase / 50Hz	3 Phase / 50Hz	1 Phase / 50Hz	3 Phase / 50Hz	1 Phase / 50Hz	3 Phase / 50Hz	
	V	230V 240V	230V 240V	400V 415V	230V 240V	400V 415V	230V 240V	400V 415V	
Current (rated)	Cooling : Heating	A	8.20 : 9.45 7.90 : 9.05	10.4 : 12.4	3.65 : 4.35 3.45 : 4.15	16.1 : 17.3 15.5 : 16.6	5.40 : 5.85 5.20 : 5.65	19.5 : 21.5 18.7 : 20.6	6.55 : 7.30 6.30 : 6.95
Dimension	H x W x D	mm	996 x 940 x 340	1,416 x 940 x 340	1,416 x 940 x 340	1,416 x 940 x 340	1,416 x 940 x 340	1,416 x 940 x 340	
Net weight	kg	66	99	99	99	99	99	99	
Air volume	Cooling : Heating	L/s	1,018 : 1,002	1,970 : 1,803	1,970 : 1,803	2,087 : 1,870	2,087 : 1,870	2,154 : 1,937	2,154 : 1,937
Sound pressure level (Silent mode)	Cooling : Heating	dB(A)	48 (46) : 50 (48)	52 (50) : 52 (50)	52 (50) : 52 (50)	53 (51) : 53 (51)	54 (52) : 54 (52)	54 (52) : 54 (52)	
Sound power level (Silent mode)	Cooling : Heating	dB	64 (62) : 66 (64)	68 (66) : 68 (66)	68 (66) : 68 (66)	69 (67) : 69 (67)	70 (68) : 70 (68)	70 (68) : 70 (68)	
Piping connections	Liquid / Gas	mm	Ø9.52 / Ø15.88	Ø9.52 / Ø15.88	Ø9.52 / Ø15.88	Ø9.52 / Ø15.88	Ø9.52 / Ø15.88	Ø9.52 / Ø15.88	
Pipe length range	min. - max.	m	5 - 50	5 - 85	5 - 85	5 - 85	5 - 85	5 - 85	
Elevation difference (OU located lower, OU located higher)	m	15, 30	15, 30	15, 30	15, 30	15, 30	15, 30	15, 30	
Maximum chargeless length	m	30	30	30	30	30	30	30	
Refrigerant at shipping / Additional gas amount	g	R32 1,950 / 45 (g/m)	R32 3,050 / 45 (g/m)	R32 3,050 / 45 (g/m)	R32 3,050 / 45 (g/m)	R32 3,050 / 45 (g/m)	R32 3,050 / 45 (g/m)	R32 3,050 / 45 (g/m)	
Operating range	Cooling : Heating	°C	-15 to 48 : -20 to 24	-15 to 48 : -20 to 24	-15 to 48 : -20 to 24	-15 to 48 : -20 to 24	-15 to 48 : -20 to 24	-15 to 48 : -20 to 24	

Specifications of R32 Compact Model R32

Capacity		6.0kW		6.8kW		10.0kW		12.5kW		13.6kW	
Model Name	Indoor Unit	S-6071PT3E	S-6071PT3E	S-1014PT3E	S-1014PT3E	S-1014PT3E	S-1014PT3E	S-1014PT3E	S-1014PT3E	S-1014PT3E	S-1014PT3E
	Outdoor Unit	U-60PZ3R5	U-71PZ3R5	U-100PZ3R5	U-100PZ3R8	U-125PZ3R5	U-125PZ3R8	U-140PZ3R5	U-140PZ3R8		
Cooling capacity : Heating capacity	kW	6.0 (2.0 - 7.1) 6.0 (1.8 - 7.0)	6.8 (2.1 - 7.7) 6.8 (2.1 - 8.1)	10.0 (3.0 - 11.5) 10.0 (3.0 - 14.0)	10.0 (3.0 - 11.5) 10.0 (3.0 - 14.0)	12.5 (3.2 - 13.5) 12.5 (3.3 - 15.0)	12.5 (3.2 - 13.5) 12.5 (3.3 - 15.0)	13.6 (3.3 - 15.0) 14.0 (3.4 - 16.0)	13.6 (3.3 - 15.0) 14.0 (3.4 - 16.0)		
	BTU/h	20,500 (6,800 - 24,200) 20,500 (6,100 - 23,900)	23,200 (8,900 - 26,300) 23,200 (7,200 - 27,600)	34,100 (10,200 - 39,200) 34,100 (10,200 - 47,800)	34,100 (10,200 - 39,200) 34,100 (10,200 - 47,800)	42,700 (10,900 - 46,100) 42,700 (11,300 - 51,200)	42,700 (10,900 - 46,100) 42,700 (11,300 - 51,200)	46,400 (11,300 - 51,200) 47,800 (11,600 - 54,600)	46,400 (11,300 - 51,200) 47,800 (11,600 - 54,600)		
EER : COP	W/W	3.82 : 4.41	3.33 : 4.22	3.64 : 4.24	3.64 : 4.24	3.32 : 3.89	3.32 : 3.89	3.15 : 3.70	3.15 : 3.70		
COP@H2 condition	W/W	3.19	3.24	2.70	2.70	2.57	2.57	2.53	2.53		
Total power input	kW	1.57 : 1.36	2.04 : 1.61	2.75 : 2.36	2.75 : 2.36	3.76 : 3.21	3.76 : 3.21	4.32 : 3.78	4.32 : 3.78		
TCSPF : HSPF	Residential	Hot Climate	5.18 : 5.97	5.02 : 5.60	5.24 : 5.58	5.24 : 5.58	4.98 : 5.36	4.98 : 5.36	4.81 : 5.25	4.81 : 5.25	
		Average Climate	4.54 : 4.88	4.45 : 4.76	4.63 : 4.78	4.63 : 4.78	4.44 : 4.45	4.44 : 4.45	4.33 : 4.25	4.33 : 4.25	
		Cold Climate	4.61 : 4.12	4.60 : 4.09	4.70 : 4.15	4.70 : 4.15	4.57 : 3.76	4.57 : 3.76	4.48 : 3.55	4.48 : 3.55	
	Commercial	Hot Climate	5.63 : 6.03	5.57 : 5.63	5.84 : 5.60	5.84 : 5.60	5.52 : 5.44	5.52 : 5.44	5.35 : 5.39	5.35 : 5.39	
		Average Climate	5.63 : 5.40	5.69 : 5.14	6.12 : 5.14	6.12 : 5.14	5.76 : 4.91	5.76 : 4.91	5.67 : 4.80	5.67 : 4.80	
		Cold Climate	5.98 : 4.66	6.18 : 4.53	6.63 : 4.57	6.63 : 4.57	6.25 : 4.25	6.25 : 4.25	6.20 : 4.09	6.20 : 4.09	
Indoor Unit											
Power source	Phase/Hz	1 Phase / 50Hz	1 Phase / 50Hz	1 Phase / 50Hz	1 Phase / 50Hz	1 Phase / 50Hz	1 Phase / 50Hz	1 Phase / 50Hz	1 Phase / 50Hz		
	V	230V 240V	230V 240V	230V 240V	230V 240V	230V 240V	230V 240V	230V 240V	230V 240V		
Dimension	H x W x D	Indoor	mm	235 X 1,275 X 690	235 X 1,275 X 690	235 X 1,590 X 690	235 X 1,590 X 690	235 X 1,590 X 690	235 X 1,590 X 690	235 X 1,590 X 690	
Net weight	Indoor	kg	34	40	40	40	40	40	40		
Air volume (H/M/L)	Cooling : Heating	L/s	334 / 283 / 242 : 334 / 283 / 242	350 / 300 / 258 : 350 / 300 / 258	501 / 417 / 384 : 501 / 417 / 384	501 / 417 / 384 : 501 / 417 / 384	567 / 467 / 400 : 567 / 467 / 400	567 / 467 / 400 : 567 / 467 / 400	584 / 484 / 417 : 584 / 484 / 417	584 / 484 / 417 : 584 / 484 / 417	
Sound pressure level (H/M/L)	Cooling : Heating	dB(A)	38 / 34 / 29 : 38 / 34 / 29	39 / 35 / 30 : 39 / 35 / 30	42 / 37 / 34 : 42 / 37 / 34	42 / 37 / 34 : 42 / 37 / 34	46 / 40 / 35 : 46 / 40 / 35	46 / 40 / 35 : 46 / 40 / 35	47 / 41 / 36 : 47 / 41 / 36	47 / 41 / 36 : 47 / 41 / 36	
Sound power level (H/M/L)	Cooling : Heating	dB	56 / 52 / 47 : 56 / 52 / 47	57 / 53 / 48 : 57 / 53 / 48	60 / 55 / 52 : 60 / 55 / 52	60 / 55 / 52 : 60 / 55 / 52	64 / 58 / 53 : 64 / 58 / 53	64 / 58 / 53 : 64 / 58 / 53	65 / 59 / 54 : 65 / 59 / 54	65 / 59 / 54 : 65 / 59 / 54	
Number of fan speeds			5	5	5	5	5	5	5		
Drain piping	mm	VP-20	VP-20	VP-20	VP-20	VP-20	VP-20	VP-20	VP-20		
Outdoor Unit											
Power source	Phase/Hz	1 Phase / 50Hz	1 Phase / 50Hz	1 Phase / 50Hz	3 Phase / 50Hz	1 Phase / 50Hz	3 Phase / 50Hz	1 Phase / 50Hz	3 Phase / 50Hz		
	V	230V 240V	230V 240V	230V 240V	400V 415V	230V 240V	400V 415V	230V 240V	400V 415V		
Current (rated)	Cooling : Heating	A	7.20 : 6.05 6.90 : 5.80	9.45 : 7.15 9.05 : 6.85	13.1 : 11.3 12.6 : 10.8	4.35 : 3.75 4.20 : 3.60	17.4 : 14.8 16.7 : 14.2	5.75 : 4.95 5.55 : 4.75	20.0 : 17.5 19.1 : 16.8	6.65 : 5.80 6.40 : 5.60	
Dimension	H x W x D	mm	695 x 875 x 320	695 x 875 x 320	996 x 980 x 370	996 x 980 x 370	996 x 980 x 370	996 x 980 x 370	996 x 980 x 370		
Net weight	kg	43	50	83	83	87	87	87	87		
Air volume	Cooling : Heating	L/s	701 : 701	746 : 766	1,219 : 1,219	1,219 : 1,219	1,369 : 1,336	1,369 : 1,336	1,402 : 1,369	1,402 : 1,369	
Sound pressure level (Silent mode)	Cooling : Heating	dB(A)	48 (46) : 49 (47)	49 (47) : 49 (47)	52 (50) : 52 (50)	52 (50) : 52 (50)	55 (53) : 55 (53)	55 (53) : 55 (53)	56 (54) : 56 (54)	56 (54) : 56 (54)	
Sound power level (Silent mode)	Cooling : Heating	dB	66 (64) : 67 (65)	67 (65) : 67 (65)	70 (68) : 70 (68)	70 (68) : 70 (68)	73 (71) : 73 (71)	73 (71) : 73 (71)	74 (72) : 74 (72)	74 (72) : 74 (72)	
Piping connections	Liquid / Gas	mm	Ø6.35 / Ø12.7*	Ø6.35 / Ø15.88*	Ø9.52 / Ø15.88	Ø9.52 / Ø15.88	Ø9.52 / Ø15.88	Ø9.52 / Ø15.88	Ø9.52 / Ø15.88		
Pipe length range	min. - max.	m	3 - 40	3 - 40	5 - 50	5 - 50	5 - 50	5 - 50	5 - 50		
Elevation difference (OU located lower, OU located higher)	m	15, 30	15, 30	15, 30	15, 30	15, 30	15, 30	15, 30	15, 30		
Maximum chargeless length	m	30	30	30	30	30	30	30	30		
Refrigerant at shipping / Additional gas amount	g	R32 1,130 / 15 (g/m)	R32 1,320 / 17 (g/m)	R32 2,400 / 45 (g/m)	R32 2,400 / 45 (g/m)	R32 2,800 / 45 (g/m)	R32 2,800 / 45 (g/m)	R32 2,800 / 45 (g/m)	R32 2,800 / 45 (g/m)		
Operating range	Cooling : Heating	°C	-10 to 46 : -15 to 24	-10 to 46 : -15 to 24	-10 to 46 : -15 to 24	-10 to 46 : -15 to 24	-10 to 46 : -15 to 24	-10 to 46 : -15 to 24	-10 to 46 : -15 to 24		

Notes:

- In the case of nanoe X OFF
- In case it is necessary to indicate the air flow volume in (l/s), the value in (m³/min.) shall be multiplied by 16.7 and rounded down the decimal point.
- AEEER and ACOP classification is at 23

Wall Mounted

Providing small, lightweight and low noise level design, it is ideal for small offices and other commercial applications. It also has a stylish smooth design with a washable front panel.

nanoe™ X
nanoe™ X as a standard*
*nanoe X Generator Mark 2

ECONAVI

ECONAVI ready



S-100PK3R

-
-
-
-
-
-
-



CZ-RTC6BL CZ-RTC6BLW CZ-RTC5B CZ-RTC4 CZ-CAPWFC1 CZ-CENSC1

Note: Product image not to scale.

Technical focus

- Closed discharge port when not in use
- Lighter and smaller units make installation easy
- Quiet operation
- Smooth and durable design
- Piping outlet in six directions
- Washable front panel
- Air distribution is automatically altered depending on the operational mode of the unit

Closed discharge port

When the unit is turned off, the flap closes completely to prevent entry of dust into the unit and to keep the equipment clean.

Quiet operation

Low operating noise level makes these units ideal for hotels and hospital applications.

Piping outlet in six directions

Piping outlet is possible in the six directions of right, right rear, right bottom, left, left rear, left bottom, making installation easier.

Washable front panel

The indoor unit's front panel can be easily cleaned for trouble-free maintenance.



Air distribution is automatically adjusted depending on the operational mode of the unit

Air outlet angle is automatically adjusted for cooling and heating operation.

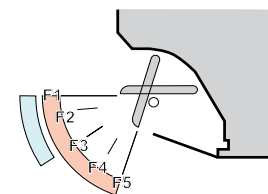

- Heating: F1 to F5
- Cooling: F1 to F3

Specifications R32 REFRIGERANT

Capacity		9.5kW		9.0kW		
Model Name	Indoor Unit / Outdoor Unit	S-100PK3R / U-100PZH3R5	S-100PK3R / U-100PZH3R8	S-100PK3R / U-100PZ3R5	S-100PK3R / U-100PZ3R8	
Cooling capacity : Heating capacity	kW	9.5 (3.1 - 10.5) / 9.5 (3.1 - 11.5)	9.5 (3.1 - 10.5) / 9.5 (3.1 - 11.5)	9.0 (3.0 - 9.7) / 9.0 (3.0 - 10.5)	9.0 (3.0 - 9.7) / 9.0 (3.0 - 10.5)	
	BTU/h	32,400 (10,600 - 35,800) / 32,400 (10,600 - 39,200)	32,400 (10,600 - 35,800) / 32,400 (10,600 - 39,200)	30,700 (10,200 - 33,100) / 30,700 (10,200 - 35,800)	30,700 (10,200 - 33,100) / 30,700 (10,200 - 35,800)	
EER : COP	W/W	3.26 : 3.97	3.26 : 3.97	3.47 : 3.93	3.47 : 3.93	
COP@H2 condition	W/W	2.50	2.50	2.53	2.53	
Total power input	Cooling : Heating kW	2.91 : 2.39 / 5.07 : 5.70	2.91 : 2.39 / 5.07 : 5.70	2.59 : 2.29 / 4.85 : 5.29	2.59 : 2.29 / 4.85 : 5.29	
	Hot Climate	5.07 : 5.70	5.07 : 5.70	4.85 : 5.29	4.85 : 5.29	
TCSPF : HSPF	Residential	Average Climate	4.52 : 4.74	4.52 : 4.74	4.21 : 4.55	4.21 : 4.55
		Cold Climate	4.72 : 4.10	4.72 : 4.10	4.27 : 3.99	4.27 : 3.99
	Commercial	Hot Climate	5.68 : 5.77	5.68 : 5.77	5.39 : 5.31	5.39 : 5.31
		Average Climate	5.85 : 5.20	5.85 : 5.20	5.42 : 4.87	5.42 : 4.87
Cold Climate	6.42 : 4.59	6.42 : 4.59	5.82 : 4.37	5.82 : 4.37		
Indoor Unit		Phase/Hz		1 Phase / 50Hz		
Power source	V	230V 240V		230V 240V		
Dimensions H x W x D	Indoor mm	302 x 1,120 x 236		302 x 1,120 x 236		
Net weight	kg	14		14		
Air volume (H/M/L)	Cooling : Heating L/s	367 / 308 / 250 / 367 / 308 / 250		367 / 308 / 250 / 367 / 308 / 250		
	Hot Climate	367 / 308 / 250		367 / 308 / 250		
Sound pressure level (H/M/L)	Cooling : Heating dB(A)	49 / 45 / 41 : 49 / 45 / 41		49 / 45 / 41 : 49 / 45 / 41		
Sound power level (H/M/L)	Cooling : Heating dB	65 / 61 / 57 : 65 / 61 / 57		65 / 61 / 57 : 65 / 61 / 57		
Number of fan speeds		5		5		
Drain pipe size	mm	VP-16		VP-16		
Outdoor Unit		Phase/Hz		1 Phase / 50Hz		
Power source	V	230V 240V		230V 240V		
Current (rated)	Cooling : Heating A	13.8 : 11.3 13.2 : 10.8		12.4 : 10.9 11.9 : 10.5		
Dimensions H x W x D	mm	1,416 x 940 x 340		996 x 980 x 370		
Net weight	kg	99		83		
Air volume	Cooling : Heating m³/min	1,970 : 1,803		1,219 : 1,219		
Sound pressure level (Silent mode)	Cooling : Heating dB(A)	52 (50) : 52 (50)		52 (50) : 52 (50)		
Sound power level (Silent mode)	Cooling : Heating dB	68 (66) : 68 (66)		70 (68) : 70 (68)		
Piping connections	Liquid / Gas mm	Ø9.52 / Ø15.88		Ø9.52 / Ø15.88		
Pipe length range	min. - max. m	5 - 85		5 - 50		
Elevation difference (OU located lower, OU located higher)	m	15, 30		15, 30		
Maximum chargeless length	m	30		30		
Refrigerant at shipping, Additional gas amount	g	R32 3,050 / 45 (g/m)		R32 2,400 / 45 (g/m)		
Operating range	Cooling : Heating °C	-15 to 48 : -20 to 24		-10 to 46 : -15 to 24		

- Notes:
- In the case of nanoe X OFF
 - In case it is necessary to indicate the air flow volume in (l/s), the value in (m³/min.) shall be multiplied by 16.7 and rounded down the decimal point.
 - AEER and ACOP classification is at 230V(400V) only in accordance with GEMS2019.
 - TCSPF, HSPF and Total Energy consumption indicate the value of average temperature zone.
 - Indoor and outdoor sound levels are determined in an anechoic chamber and may differ once the unit is installed due to ambient conditions
 - H:High at setting 5 stage (Level 5), M:Middle at setting 5 stage (Level 3), L:Low at setting 5 stage (Level 1)

Floor Console

This floor-type console's slender profile integrates unobtrusively into any interior, in a position that's also ideal when you want to warm your feet when it's cold.

nanoe™ X
nanoe™ X as a standard*
*nanoe X Generator Mark 1



CS-Z25UFRAW
CS-Z35UFRAW
CS-Z50UFRAW









Wireless remote controller included.



CZ-TACG1*1

Note: Product image not to scale.

-  Self-diagnosing Function
-  Automatic Fan Operation
-  DRY mode
-  Automatic Restart Function
-  Auto Swing (Auto Flap Control)
-  DC Motor

Technical focus

- A breakthrough design that integrates perfectly with the most modern environments.
- Compact design fits 50mm wall recess

Upper & Lower Vane Blow

Optimum air flow from the top and bottom of the unit assures that even your feet are kept comfortably warm. (Only during heating)

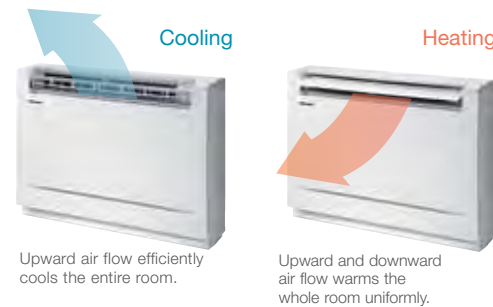

Compact Design

The design features a flat, elegant front panel that provides a neat appearance and the unit can be recessed into a wall up to 50 mm.



Super Quiet

The indoor and outdoor units deliver quiet operation and pressing the Quiet mode button lowers operation noise even further to just 19dB for indoor unit with low fan speed.

19dB*1
Indoor



*1 CS-Z25UFRAW & CS-Z35UFRAW: In the Quiet mode during heating operation with low fan speed.

Specifications of Current Model



Capacity		2.5kW	3.5kW	5.0kW
Model Name	Indoor Unit	CS-Z25UFRAW	CS-Z35UFRAW	CS-Z50UFRAW
	Outdoor Unit	CU-Z25UBRA	CU-Z35UBRA	CU-Z50UBRA
Cooling capacity : Heating capacity	kW	2.50 (0.85~3.40) 3.40 (0.85~5.00)	3.50 (0.85~3.80) 4.30 (0.85~6.00)	5.00 (0.90~5.70) 5.60 (0.90~8.10)
	BTU/h	8,530 (2,900~11,600) 11,600 (2,900~17,100)	11,900 (2,900~13,000) 14,700 (2,900~20,500)	17,100 (3,070~19,400) 19,100 (3,070~27,600)
EER : COP	W/W	5.00 : 4.59	4.07 : 4.06	3.65 : 3.81
Power input (min-max)	Cooling : Heating	0.50 (0.24-0.90) 0.74 (0.24-1.35)	0.86 (0.24-1.02) 1.06 (0.24-1.75)	1.37(0.26-1.81) : 1.47 (0.26-2.60)
	Hot Climate	5.70 : 4.12	5.46 : 4.49	5.51 : 4.48
TCSPF : HSPF	Residential	Average Climate	5.05 : 4.21	5.01 : 4.29
		Cold Climate	4.97 : 3.94	5.07 : 3.78
	Commercial	Hot Climate	6.22 : 3.89	6.01 : 4.18
		Average Climate	6.40 : 3.85	6.80 : 4.00
Cold Climate	6.97 : 3.78	7.31 : 3.80	8.46 : 3.76	
Indoor Unit				
Power source	Phase/Hz V	1 Phase / 50Hz 230V 240V	1 Phase / 50Hz 230V 240V	1 Phase / 50Hz 230V 240V
Dimensions	H x W x D	600 x 750 x 207	600 x 750 x 207	600 x 750 x 207
Net weight	kg	13	13	13
Air volume	Cooling : Heating	L/s	163 : 173	170 : 182
Sound pressure level (H/M/L)	Cooling : Heating	dB(A)	38 / 25 / 20 : 38 / 25 / 19	39 / 26 / 20 : 39 / 25 / 19
Sound power level (H/M/L)	Cooling : Heating	dB(A)	54 / 41 / 36 : 54 / 41 / 35	55 / 42 / 36 : 55 / 41 / 35
Outdoor Unit				
Power source	Phase/Hz V	1 Phase / 50Hz 230V 240V	1 Phase / 50Hz 230V 240V	1 Phase / 50Hz 230V 240V
Current (rated)	Cooling : Heating	A	2.40 : 3.40 2.30 : 3.25	3.90 : 4.80 3.70 : 4.60
Dimensions	H x W x D	mm	542 x 780 x 289	619 x 824 x 299
Net weight	kg	33	35	42
Piping connections	Liquid / Gas	m	Ø6.35 / Ø9.52	Ø6.35 / Ø9.52
Pipe length	min. - max.	m	3 - 20	3 - 30
Elevation difference	m	15	15	20
Piping connections	Cooling : Heating	°C	-10 to 46 : -15 to 24	-10 to 46 : -15 to 24

Notes:

The Rated Capacity, Power Input and Running Current are measured in accordance with AS/NZS 3823

- Cooling: Indoor temperature: 27°C DB/ 19°C WB, Outdoor temperature: 35°C DB/ 24°C WB
- Heating: Indoor temperature: 20°C DB/ 15°C WB, Outdoor temperature: 7°C DB/ 6°C WB
- Indoor and outdoor sound levels are determined in an anechoic chamber and may differ once the unit is installed due to ambient conditions.
- Floor console is not supported by PAC Smart Connectivity+.

*1 If you connect WLAN adaptor (CZ-TACG1) to an indoor unit other than wall mounted type and operate from the smartphone with Panasonic Comfort Cloud App, airflow direction may not be operated as it is shown on the display.

Indoor Unit Dimensions

HIGH STATIC PRESSURE DUCTED

Dimensions (6.0kW – 16.0kW)

S-60PE3R / S-71PE3R / S-100PE3R / S-125PE3R / S-140PE3R / S-160PE3R

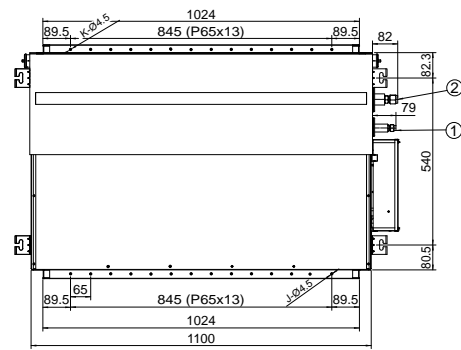

TYPE	E	F	G	H	J	K
S-60PE3R	130 (P65x2)	33.1	290	118	34	34
S-71PE3R S-100PE3R	195 (P65x3)	35.7	360	50	36	36
S-125PE3R S-140PE3R S-160PE3R	260 (P65x4)	38.2	430	121.5	38	38

- ① Refrigerant liquid tubing (Flare) $\phi 9.52$
 - ② Refrigerant gas tubing (Flare) $\phi 15.88$
 - ③ Air intake High Static Pressure duct connecting side flange
 - ④ Air discharge High Static Pressure duct connecting side flange
 - ⑤ Drain port
- The PZ3 series type 60 and 71 outdoor unit refrigerant pipe is different dimension from indoor unit. Refer to technical data for more details.

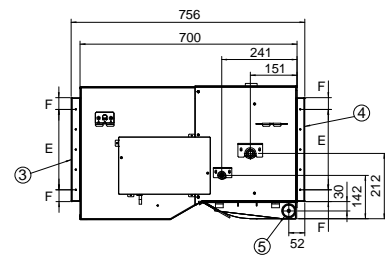
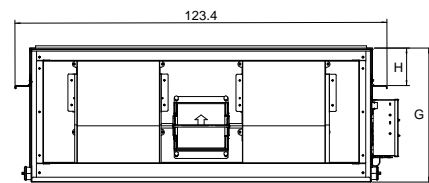

unit: mm

HIGH STATIC PRESSURE SPLITTABLE DUCTED

Dimensions (18.0kW – 22.4kW)

S-180PE3R5B / S-200PE3R5B / S-224PE3R5B

- 1 Refrigerant liquid tubing (Flare)
Type 180 : $\phi 9.52$
Type 200/224 : $\phi 12.7$
- 2 Refrigerant gas tubing (Brazing)
 $\phi 19.05$
(Type 180 (50 - 75m) :
Connection tubing $\phi 19.05 \rightarrow \phi 25.4$
Type 200/224 (30 - 60m) :
Connection tubing $\phi 19.05 \rightarrow \phi 25.4$)
- 3 Power supply port
- 4 Communication port
- 5 Drain port
- 6 Air intake duct connecting side flange
- 7 Air discharge duct connecting side flange

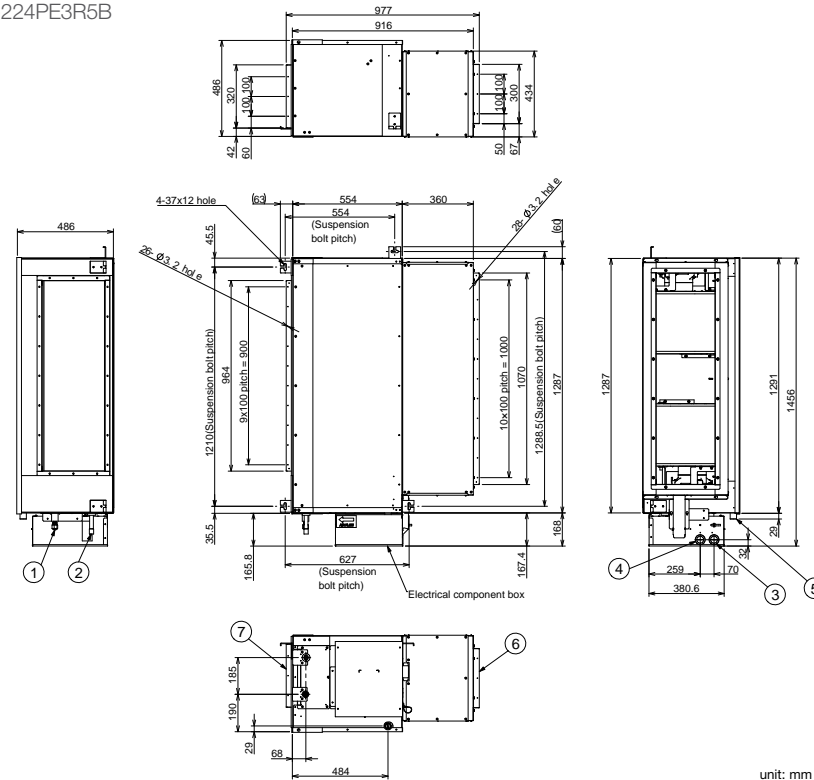

unit: mm

HIGH STATIC PRESSURE ADAPTIVE DUCTED

Dimensions (3.6kW – 14.0kW)

S-3650PF3E / S-6071PF3E / S-1014PF3E

Detailed dimensions of indoor unit

Type	A	B	C	D	E	F
3650	867	800	450 (Pitch 150 x 3)	71	592	12
6071	1,067	1,000	750 (Pitch 150 x 5)	21	792	16
1014	1,467	1,400	1,050 (Pitch 150 x 7)	71	1,192	20

- a) Refrigerant tubing joint (liquid tube)
- b) Refrigerant tubing joint (gas tube)
- c) Upper drain port VP20 ($\phi 26$ mm)
200 mm flexible hose supplied
- d) Bottom drain port VP20 ($\phi 26$ mm)
- e) Suspension lug (4 – 12 x 30 mm)
- f) Power supply outlet
- g) Fresh air intake port ($\phi 100$ mm)
- h) Flange for flexible air outlet duct
- i) Electrical component box

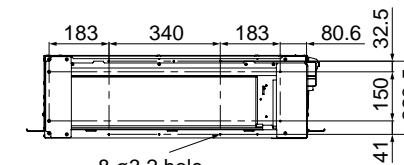

8- $\phi 3.2$ hole
For M4 self-tapping screw

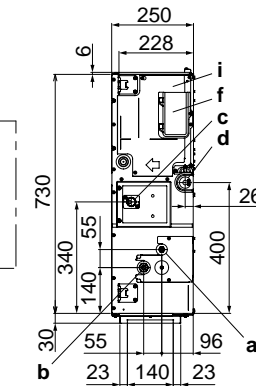
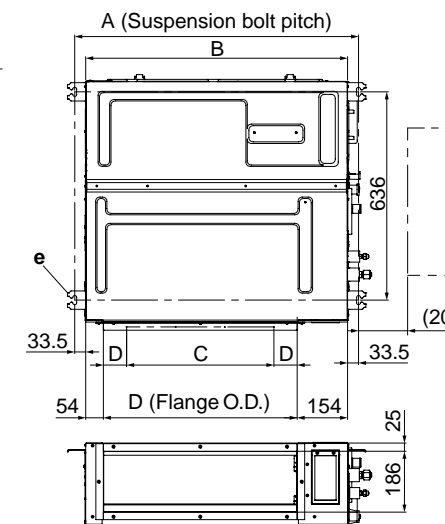
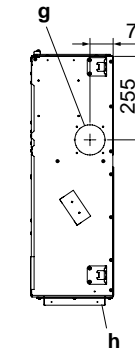

unit: mm

Indoor Unit Dimensions

ULTRA SLIM DUCTED

Dimensions (2.6kW – 5.6kW)

CS-Z25UD3RAW / CS-Z35UD3RAW / CS-Z50UD3RAW / CS-Z60UD3RAW

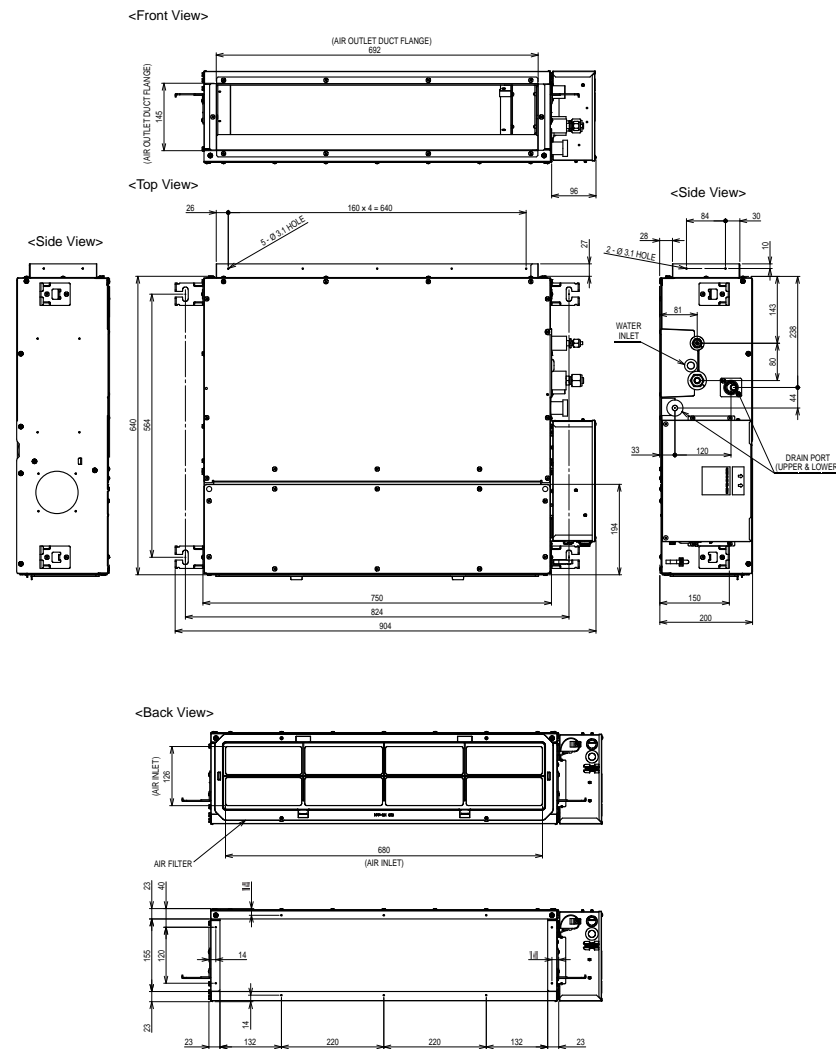

unit: mm

4-WAY CASSETTE

Dimensions (6.0kW – 14.0kW)

S-6071PU3E / S-1014PU3E

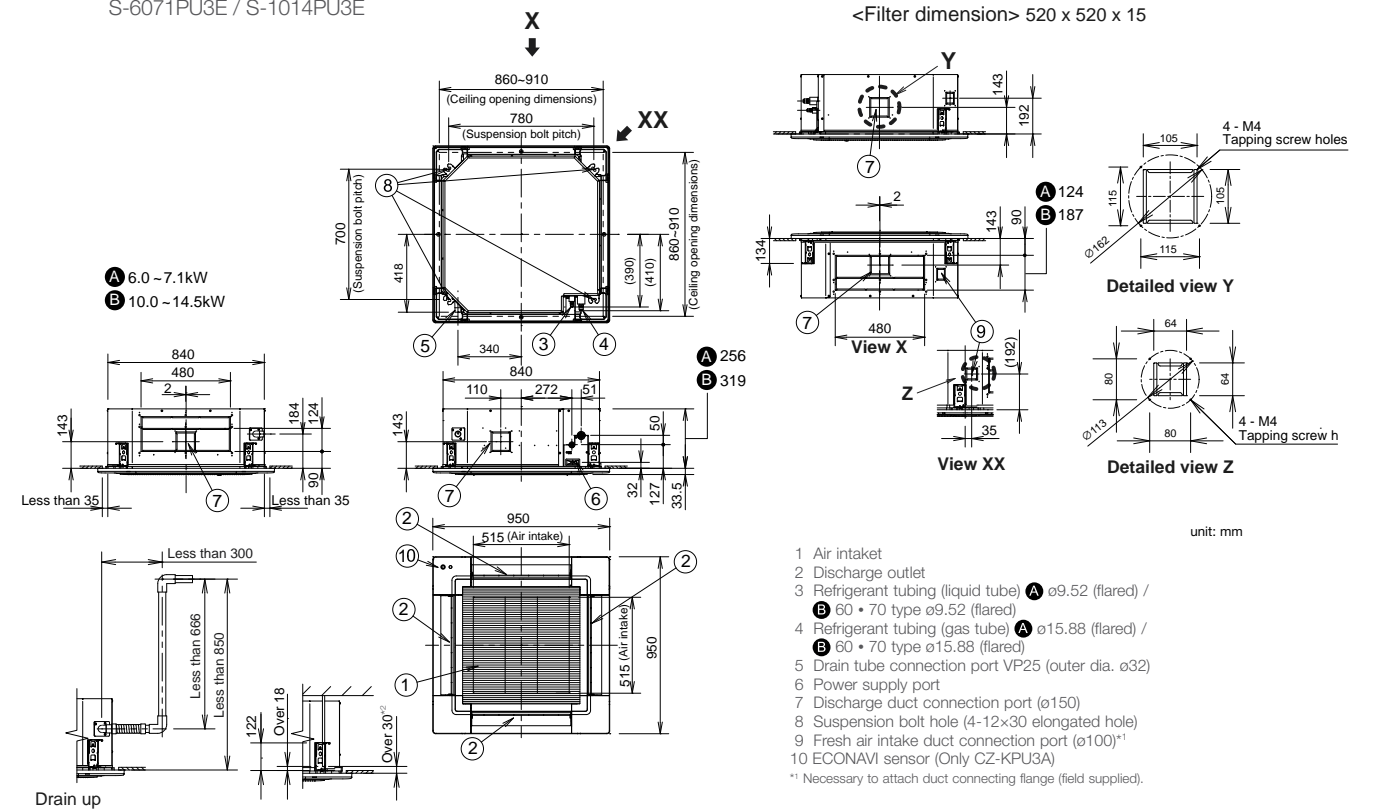

*2 Adjust the suspension bolt length so that the gap from the lower ceiling surface becomes 30 mm or more (18 mm or more from the lower surface of the body) as shown in the figure. When the suspension bolt length is long, it hits the ceiling panel and installation is not possible.

4-WAY MINI CASSETTE

Dimensions (2.5kW – 5.7kW)

CS-Z25UB4RAW / CS-Z35UB4RAW / CS-Z50UB4RAW / CS-Z60UB4RAW

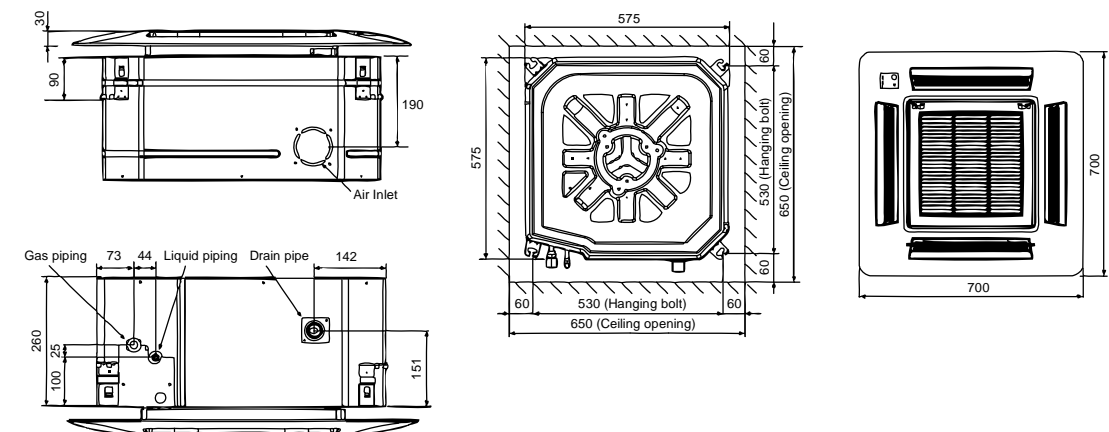

unit: mm

Indoor Unit Dimensions

UNDER CEILING

Dimensions (6.0kW – 14.0kW) S-6071PT3E

- 1 Drain port VP20 (inside diameter ϕ 26mm, drain hose supplied)
- 2 Left drain position
- 3 Refrigerant liquid tubing (ϕ 9.52mm, flare connection)
- 4 Refrigerant gas tubing (ϕ 15.88mm, flare connection)
- 5 Left side drain hose outlet port (cutout)
- 6 Tubing hole on wall surface (ϕ 100mm)
- 7 Upper side tubing port
- 8 Right side drain hose outlet port (cutout)
- 9 Wireless remote controller receiver installation location

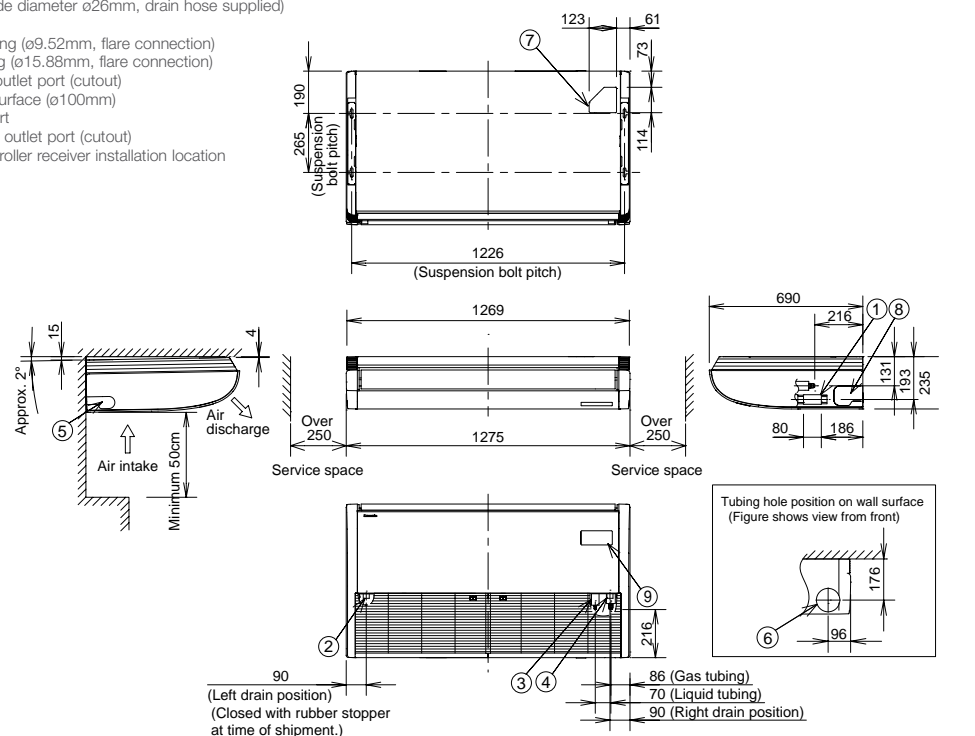

unit: mm

S-1014PT3E

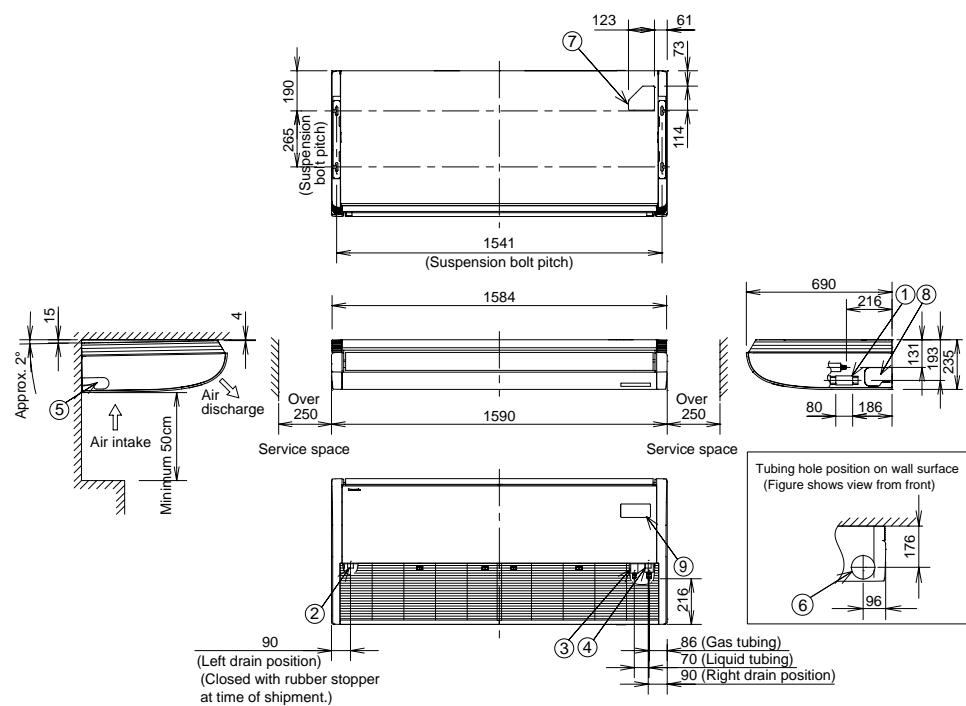

unit: mm

WALL MOUNTED

Dimensions (9.5kW) S-100PK3R

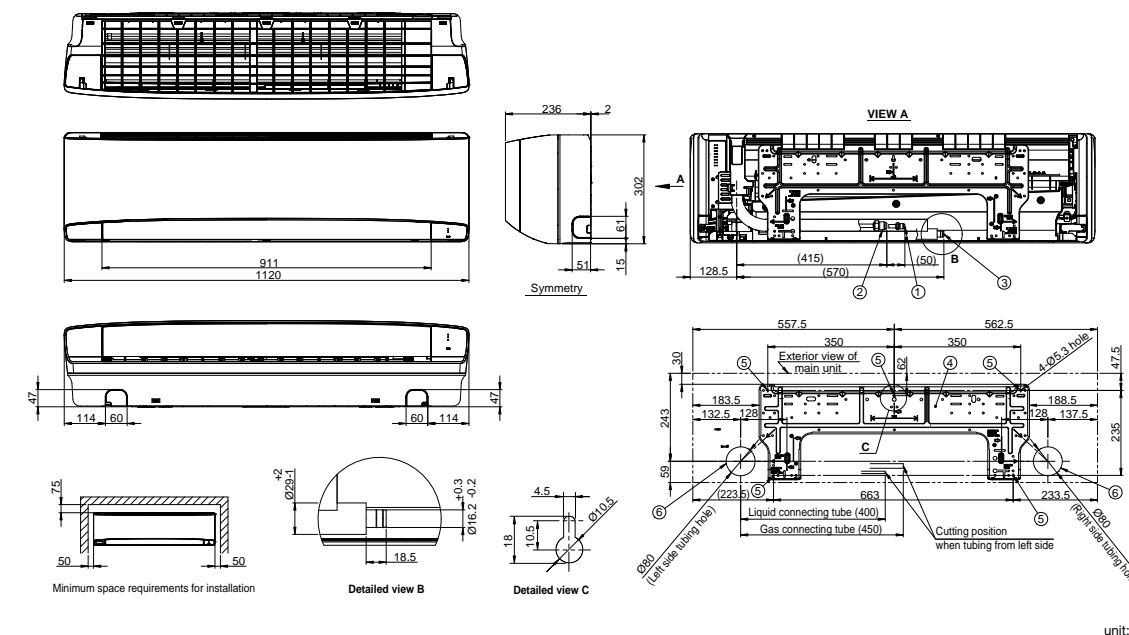

unit: mm

FLOOR CONSOLE

Dimensions (2.5kW – 5.0kW)

CS-Z25UFRW / CS-Z35UFRW / CS-Z50UFRW

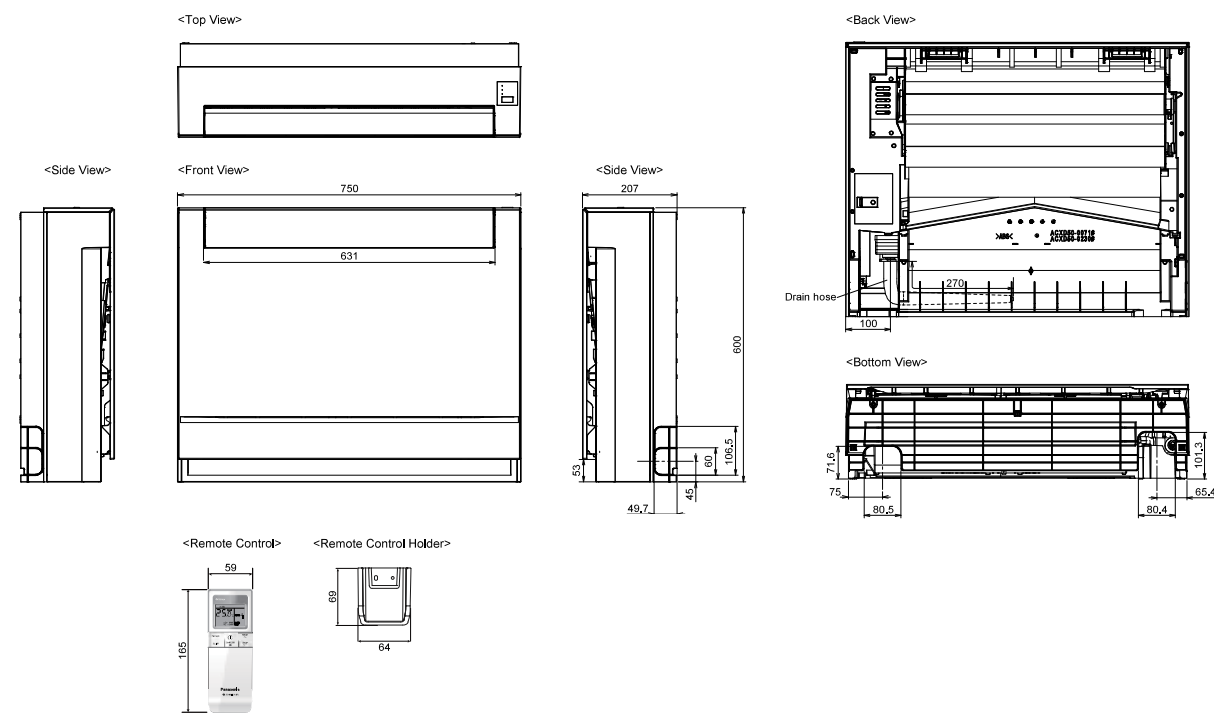

unit: mm

Smart Connectivity and Control Solutions

Panasonic offers a range of smart connectivity and control solutions for residential and commercial applications that allow you to conveniently manage and monitor air conditioning units in single or multiple locations from one mobile device. Add solutions for partners such as contractors and service providers that simplify everything from configuration to repair diagnosis and discover a streamlined, next-generation air conditioning ecosystem.



For Residential

Panasonic Comfort Cloud Home Automation Ready

Personal Control Solutions Panasonic Comfort Cloud

- Remotely manage and monitor multiple air conditioning units in your home**
Easily control and access all features of the air conditioning units with smart centralised control.
- Intuitive voice control**
Control air conditioning units by voice command connecting to smart speaker.



PLUG & PLAY FOR HOME AUTOMATION

Easily connect with integrated controllers to become part of your automated home network.



Note: For further information, please check CLIPSAL® website.

For Light Commercial

Panasonic Comfort Cloud **PAC Smart Connectivity+**

Cost effective Energy Management Solution



- Multiple location control at your convenience with Comfort Cloud**
Gain control of multiple zones and sites intuitively adjusting temperature by areas with differentiated user rights settings.
- Indoor Air Quality (IAQ) and efficient energy usage with PAC Smart Connectivity+**
 - Ultimate cooling comfort with sensing technology and automatic IAQ control.
 - Simplified Plug & Play installation with BMS connection for better energy consumption.

Wide Range of Smart Control Solutions for All Needs

Whether you're a contractor or service provider looking for solutions to streamline everything from configuration to repair diagnosis, a facility manager overseeing multiple sites or a single office, or you're simply managing a home system, we offer a range of innovative, next-generation smart control solutions to suit your needs.

For end users and facility managers

Panasonic Comfort Cloud
Intuitive and scalable air conditioning control solution using a personal mobile device.

PAC Smart Connectivity+
Offers efficient energy management with high indoor air quality (IAQ) control.

Panasonic AC Smart Cloud
Monitor and manage energy consumption of multiple location through a cloud computing system.

For contractors/service providers

H&C Diagnosis APP
H&C Control APP
Connect to APP via Bluetooth for greatly improved convenience during configuration and repair diagnosis.

For Multiple Building Management

Panasonic AC Smart Cloud

Full Control of All Installations From A Single Internet Connection Panasonic AC Smart Cloud

- Manage and monitor energy consumption patterns**
Analyse energy usage, running time and optimise temperatures to reduce energy costs.
- Centralised control solution with zero downtime**
Receive real-time status updates to prevent breakdowns.
- Flexible and scalable solution for expanding businesses and multi sites**
Adaptable solutions that can easily be upgraded for new features, meet user demand and better IT management.

*1 CZ-TACG1 or CZ-CAPWFO1 Network Adaptor required per unit. Requires an Internet connection and the App downloaded from the App Store or GooglePlay Store on your smartphone or tablet with the latest Operating System available. To use Amazon Alexa to control your air conditioner, you will need an Amazon Echo device. To use Google Assistant to control your air conditioner, you will need a Google Assistant device. Google is a trademark of Google LLC. Amazon, Alexa and all related logos are trademarks of Amazon.com, Inc. or its affiliates. Google Home and Alexa are compatible with the air conditioning systems shown on pages 4 and 5. Google and Alexa functionality is only available with complete air conditioning systems (including Panasonic controllers).

Panasonic Comfort Cloud

Control air conditioning units from wherever and whenever with your smartphone, by using Panasonic Comfort Cloud and WLAN smart adaptor. This scalable solution is ideal for one system, one site or multiple locations. Coupling the adapter with the already feature rich systems, makes it an ideal solution for both residential and commercial applications.



For Residential

Remotely manage and monitor air conditioning units from anywhere anytime.

For Light Commercial

Gain control of multiple zones and sites intuitively up to 200 indoor units.

Panasonic Comfort Cloud features

Voice Control

Control air conditioning units by voice command intuitively connecting to smart speaker.*1



Multiple User

The Panasonic Comfort Cloud App allows multiuser access control. Restrict user access to specific units.



From 1 to 200 units

User can control up to 200 indoor units. 10 different sites, with up to 20 units / groups per site.



Easy Scheduling

Complex weekly scheduling made simple. Not only for one units, but across multiple sites and from a smartphone.

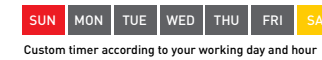

Energy Monitor

See the estimated power consumption and compare with other periods to see how energy bill can be reduced even more.*2

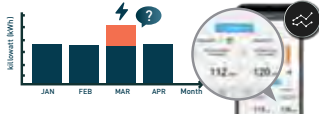

Error Codes

Error code notification through the App, provides early notification and allows for faster repair.



Application Examples



Centralised control from reception.



Multiple location control for small business.

System configuration

Network Adaptor
CZ-TACG1 CZ-CAPWFC1



Connection Diagram



Indoor Unit

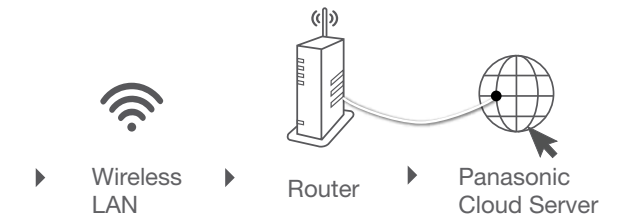

In conformity with IEEE 802.11

CZ-TACG1: For products for small sized project.
CZ-CAPWFC1: Available for all types of VRF and PAC indoor unit.

WLAN Smart Adaptor specification

	CZ-TACG1	CZ-CAPWFC1
Input Voltage	DC 12V (Supplied from indoor unit)	
Power Consumption	Maximum 0.66W	Maximum 2.4W
Size [H x W x D]	66 x 36 x 12mm	120 x 70 x 25mm
Weight	Approx. 85g	190g (including communications lines)
Interface	Wireless LAN	
Wireless LAN Standard	IEEE 802.11 b/g/n	
Frequency range	2.4GHz band	
Encryption	WPA2-PSK(TKIP/AES)	
Operation range	0-55°C, 20 - 80RH%	

*1 CZ-TACG1 or CZ-CAPWFC1 Network Adaptor required per unit. Requires an Internet connection and the App downloaded from the App Store or GooglePlay Store on your smartphone or tablet with the latest Operating System available. To use Amazon Alexa to control your air conditioner, you will need an Amazon Echo device. To use Google Assistant to control your air conditioner, you will need a Google Assistant device. Google is a trademark of Google LLC. Amazon, Alexa and all related logos are trademarks of Amazon.com, Inc. or its affiliates. Google Home and Alexa are compatible with the air conditioning systems shown on pages 4 and 5. Google and Alexa functionality is only available with complete air conditioning systems (including Panasonic controllers).
*2 Function available depending on the model.



Comfort Cloud App



Compatible Device and Browsers

1. IOS 9.0 or above
2. Android 5.0 or above

Plug & Play for Home Automation

Easily connect with integrated controllers to become part of your automated home network. Plug & Play with Clipsal solutions to enjoy simplicity you've been waiting for, empowering you to take control of your home's technology.



Easy Design / Plug & Play

Clipsal control solution brings you smart home technologies and enables you to control devices at your fingertips from any smart phone or tablet. Panasonic air conditioners are ready for this smart home automation with just plug-and-play connectivity.



Easy Design
Plug & Play

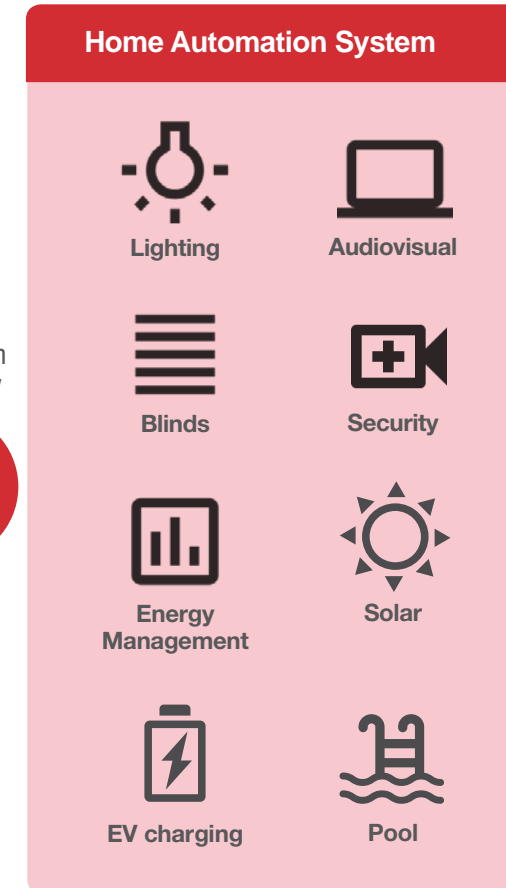

Applies to selected Panasonic Air Conditioning systems only, please consult with Panasonic for more details.

Case study

Panasonic VRF system was selected for the smart apartments, Lilydale Grove, which integrates robust automation technology to simplify your life. While other air conditioner brands need a adaptor to connect to HEMS, Panasonic can seamlessly connect with Schneider's Home automation, one of the market leaders in the HEMS industry.



- Air conditioning system FSV Heat Recovery (20 systems)
FSV Heat Pump (4 systems)
- Cooling Capacity 742kW
- Indoor units 278 units
- Control System SE8000 series 278units

Note: System combination as of July 2020

Panasonic

Schneider Electric

Panasonic partnering with Schneider Electric offering home automation solution with CLIPSAL interfaces and devices.

CLIPSAL
by Schneider Electric

Note: For further information please check CLIPSAL® website.

PAC Smart Connectivity+

Through thorough energy management, Panasonic's PAC Smart Connectivity+*1 is a completely new, state-of-the-art solution providing energy saving and comfort as well as simple installation, operation and maintenance.



PAC Smart Connectivity+ ~New SE8000 series~

1. Quality Air Control

Optimum IAQ is realized using the CO₂ & humidity sensors. The interior remains comfortable, while heating and cooling costs are minimized.

The CO₂ sensor controls ventilation systems which contributes to improving the room's air quality.



2. Room Key Card or Key Cardless Solutions for Hotels

Solutions are provided that meet the needs of various regions and hotel grades.

Whilst the previous model's automatic detection function offered optimal air conditioning with or without a hotel room key card, the latest model enables conventional key cards to control air conditioners and other devices coordinately. The increase in the types of devices that can be connected enables customized control of any hotel room.

3. Other Equipment Control

One room controller manages various devices including lighting and the blinds. A ventilation system and other external connection devices can be connected by using HRC*2 or SE8350 so that various control is possible with this controller alone, even without BMS.



PAC Smart Connectivity+

PAC Smart Connectivity+ offers efficient energy management and a new air conditioning control solution with high IAQ (Indoor Air Quality).

Energy Management System for Rooms

Each room is monitored by high-precision sensors, making it possible to make every room's temperature comfortable without wasting energy.

Management System for the Entire Building

A Building Energy Management System (BMS) can also be connected for Plug & Play centralised control of the building's entire energy consumption.

Advantages



Dramatic Reduction of OpEx with Outstanding IAQ.

- 3 Built-in sensors: Temperature, RH and Occupancy
- ZigBee wireless sensors: CO₂/Temperature/RH%, window/door, ceiling/wall



Ultimate Customisation.

- Background colour customisable
- Custom display/icons, messages
- Programmable logic (also stand alone)
- Various controls and various external connection devices



User-/Owner-friendly.

- Colour touch screen
- Ease and simply of use
- 22 Languages
- Easy-to-understand error description



Easy Design and Plug and Play to Reduce CapEx.

- Simple Plug & Play connection to Building Energy Management System (BMS)
- Stand alone or BMS connected
- Easy Installation of Zigbee Sensors

*1 Not compatible with Ultra Slim Ducted, 4-Way Mini Cassette and Floor Console systems.

*2 Available through a Schneider Electric distribution channel.

Energy Management System for Rooms

By installing a ceiling motion sensor, wall motion temperature sensor, window/door sensor, and CO₂ sensor in the room, ideal, waste-free air conditioning is achieved.

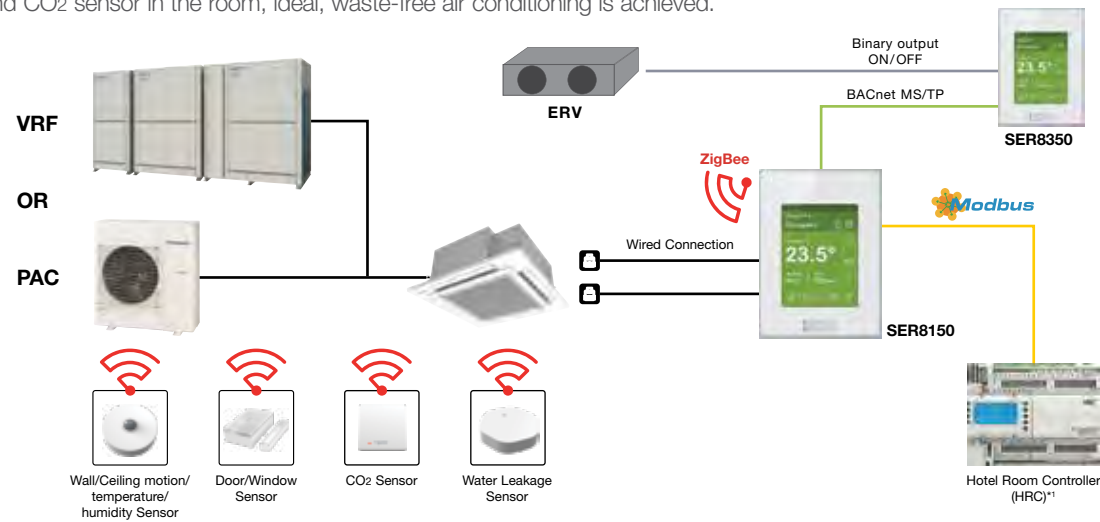

Sensing & Control technology

Using sensors from Schneider Electric, high-quality occupancy control and automatic IAQ control were realised. The sensors detect the presence or absence of occupants, and the opening and closing of doors and windows to achieve the most efficient energy management for exceptional air-conditioned comfort. Flexible installation is possible to match different applications and building features such as walls, ceilings and proximity to doors and windows. No wiring means extra installation versatility.

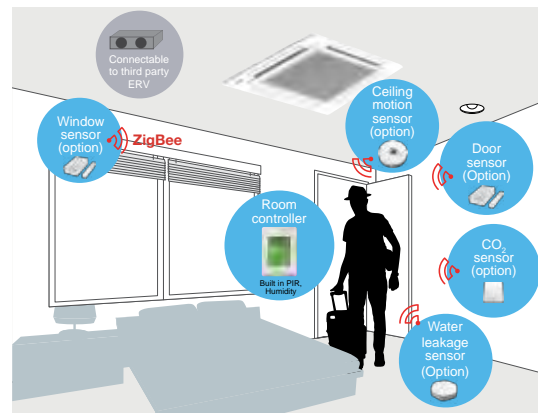

Batteries last for up to five years (10-year battery for CO₂ sensor) and are easy to install and replace.

<p>Door/Window Sensor Door and window contact detection sensor to monitor opening and closing.</p>	<p>Wall/Ceiling motion/temperature/humidity Sensor Wall and ceiling sensor to detect the presence or absence of occupants.</p>	<p>CO₂ Sensor Monitor indoor air quality, review data on interfacing devices, and control fresh air inside customizable zones.</p>
<p>Water Leakage Sensor Two sensing pads under the body activate when water is present between the two pads. Detecting the water, the sensor reports the event to the controller.</p>	<p>SER8350 Programmable controller for HVAC equipment. Includes local memory to store control sequence.</p>	<p>Hotel Room Controller (HRC)^{*1} The Hotel Room Controller controls connected guest room devices and aggregates data, making it visible to guest room and property management systems.</p>

^{*1} Available through a Schneider Electric distribution channel.

Management System for the Entire Building^{*2}

The smarter solution to simplify energy management, optimise building efficiency and drive savings.

Plug and Play BMS connection.

With the SER8150, connection to BMS is extremely easy. Better still, a remote controller is all that's needed to enable use as a stand-alone system. In addition to dramatically reducing the burden on system integrators, this cuts costs.

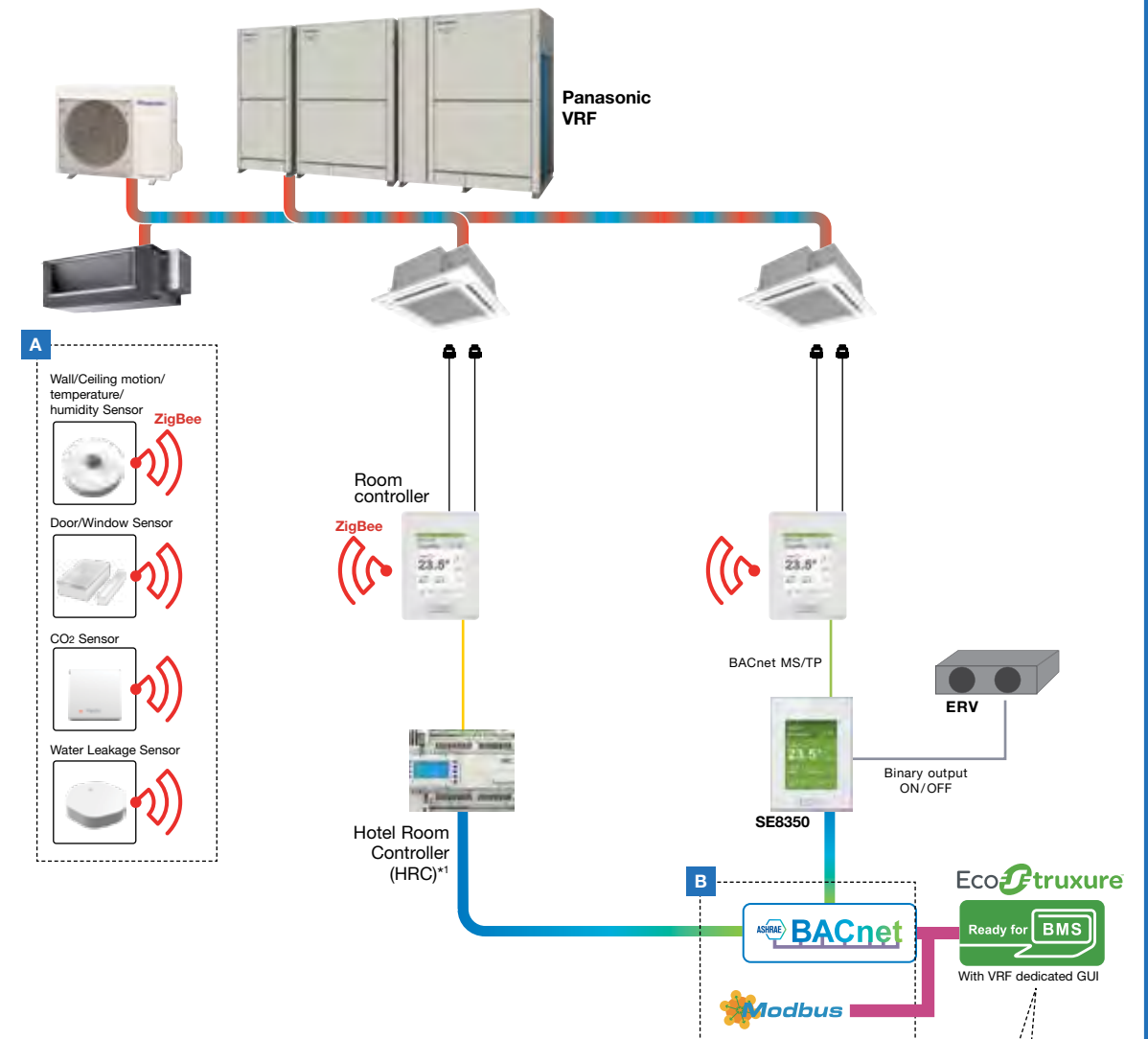

- A** SER8150 smart controller with direct hub to ZigBee[®] Pro sensors. Great Occupancy and IAQ control. Ex: Hotel room occupancy check by PIR sensor, IAQ by CO₂ sensor, Door / Window contacts.
- B** BACnet MS/TP or Modbus RTU communication are selectable
- C** For Schneider Electric BMS connection, Panasonic VRF widgets enable easy Plug and Play. Better understanding for VRF as a chiller system.

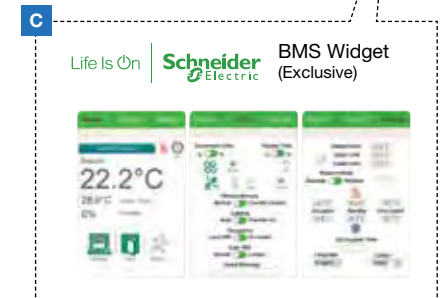

^{*2} Graphic shows combination of products from Panasonic, Schneider Electric and others. Currently, some products might not available in Australia, please consult authorised dealer for more details.

Smart Management Solutions

1 Hotels

Room Key Card or Key Cardless Solutions for Hotels

The SER8150 and ZigBee Sensor automatic detection function offer optimal air conditioning regardless of whether there is a hotel room key or not. Sensors detect the presence or absence of occupants and the opening and closing of doors and windows for the optimum air-conditioned environment guests expect. Automatic control ensures the most efficient operation when guests are away or when windows are open. This contributes to an appreciable reduction in operation costs.



2 Small and Medium Offices



CO2 sensors (option) and Humidity sensors

CO2 sensors (option) take measurements in units of ppm, and humidity sensors enable fine air quality control. This creates the most comfortable space for occupants while contributing to improved employee satisfaction.

3 Super Markets



Humidity sensors

Humidity sensors enable automatic dehumidification for the optimum IAQ regardless of climatic conditions. This creates an even more comfortable environment for customers, employees, and products themselves.

1. Remote sensing & IAQ control

In addition to detecting a room's temperature, humidity and CO2 concentration, ZigBee remote sensors detect the opening/closing of windows and doors, and the presence/absence of people in a room. Various IAQ controls and detailed energy savings are possible by using SE8350 based on this detected information.

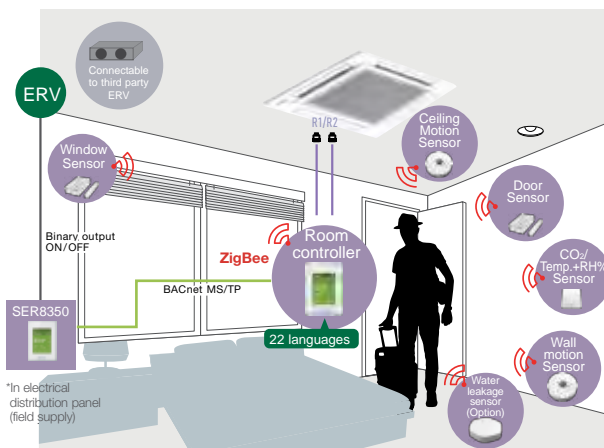

2. BMS Connectivity

By setting HRC*1 as the guestroom controller, sensing, control and BMS connection can be realized in coordination with SER8150!

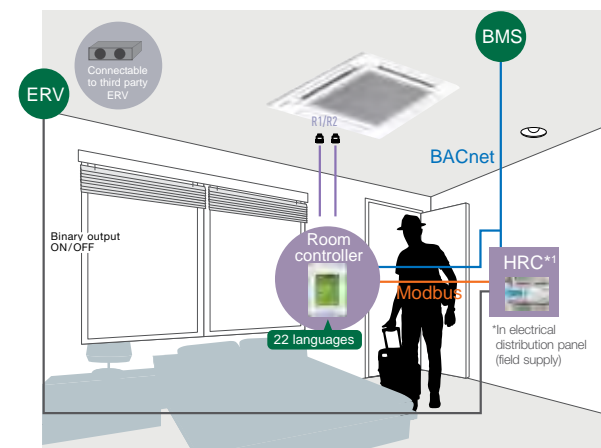

3. Key Cardless control

The introduction of SE8350 and HRC enables conventional wired keycards to be connected to the system so that it is possible to meet the specific requirements of various hotel and room types.

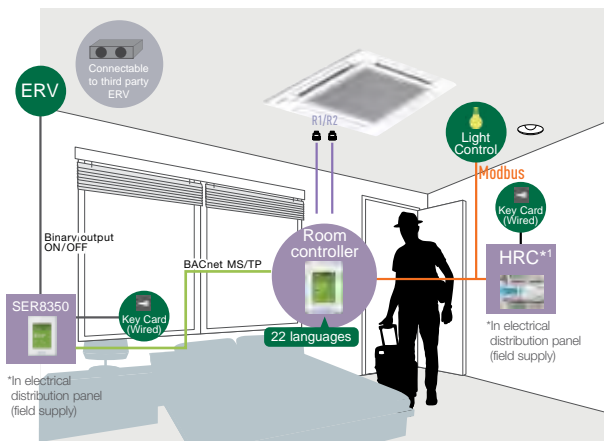

4. Other control

The introduction of SE8350 and HRC enables the on/off control of devices having dry contact input, such as ventilation, lighting and blinds.

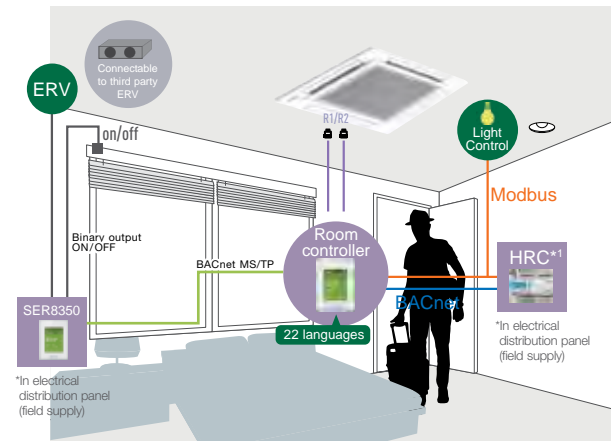

Innovative and Unrivalled Advantages

Colour and Design to Match Office Interiors

Colour combinations and design can be set to match different facilities.



Customisation in 22 Languages Possible

The display can be customised to match the native languages of guests to enable smooth, stress-free communication for hospitality at its finest.



Easy-to-Understand Error Description

Error description during an emergency is easy to understand, enabling staff to respond quickly.



Programmable Logic

Full customisation of remote control logic possible, and updating to match conditions.



Smart Connectivity Devices

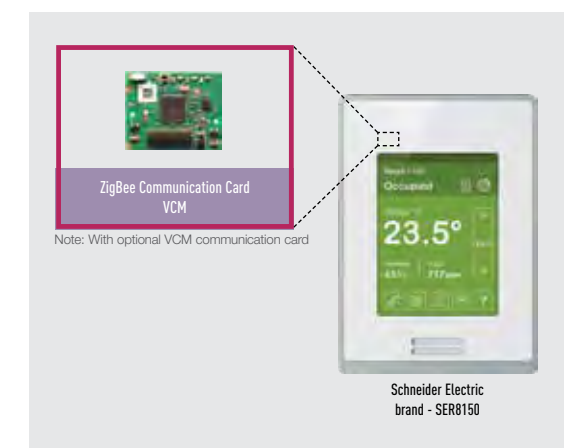

- Features**
- Up to 5-year battery life batteries included (CO2 sensor is 10 years)
 - Battery level is a point
 - Sensor points visible when SER8150 is integrated via BACnet MS/TP
 - Sensor status and battery level visible when SER8150 is integrated via ZigBee® Pro

*1 Available through a Schneider Electric distribution channel.

Reference	Description
SER815OR0B1194	Pana Net Con, RH, No PIR, SE Brand, R1R2
SER815OR5B1194	Pana Net Con, RH, PIR, SE Brand, R1R2
VCM8000V6094P	Wireless ZigBee Pro communication card
SE8350	
SE8350U0800	BACnet MS/TP, 24VAC, 7UI/4U0/4D0
HRC**	
HRCPE14R	Hotel Room Expansion Module 14IO
HRCPB628R	Hotel Room Controller 28IO
HRCPD642R	Hotel Room Controller w/Display 42IO

Reference	Description
ZigBee Sensors	
SED-CO2-G-5045	Sensor with Room CO ₂ , Temperature and Humidity
SED-TRH-G-5045	Sensor with Room Temperature and Humidity
SED-WDC-G-5045	Door/Window Sensor
SED-MTH-G-5045	Wall/Ceiling motion/temperature/humidity Sensor
SED-WLS-G-5045	Water Leakage Sensor

PAC Smart Connectivity+ controller external dimensions

Room Controller for SER8150

Dimensions

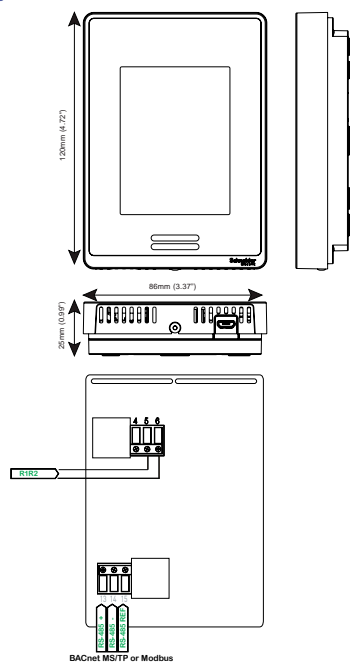

Specifications

Dimensions
 Height: 12cm/4.72in
 Width: 8.6cm/3.39in
 Depth: 2.7cm/1.06in

Power Requirements
 16 Vdc from Panasonic R-R IDU connectors
 50/60 Hz, 4VA, Class 2 Supply

Range from Indoor Unit
 Recommended 500ft (150m)

Operating Conditions
 0 °C to 50 °C (32 °F to 122 °F)
 0% to 95% R.H. non-condensing

Storage Conditions
 -30 °C to 50 °C (-22 °F to 122 °F)
 0% to 95% R.H. non-condensing

Temperature Sensor
 Local 10 K NTC type 2 thermistor

Temperature Sensor Resolution
 ± 0.1 °C (± 0.2 °F)

Temperature Sensor Accuracy
 ± 0.5 °C (± 0.9 °F) @ 21 °C (70 °F) typical calibrated

Humidity Sensor and Calibration
 Single point calibrated bulk polymer type sensor

Humidity Sensor Precision
 Reading range from 10 to 20% R.H. non-condensing 10 to 20% precision: 10%
 20% to 80% precision: 5%
 80% to 90% precision: 10%

Humidity Sensor Stability
 Less than 1.0 % yearly (typical drift)

Wiring
 Maximum wire length between last indoor unit to SER8150Rx81194 equals 490ft (150m) with AWG #18 wire (0.82 mm²). Refer to Panasonic VRF guidelines "Wiring System Diagram for Remote Controller" for this limitation.

Approximate Shipping Weight
 0.34 kg (0.75 lb)

Check with your local government for instruction on disposal of these products.

THIS PRODUCT FOR COMMERCIAL USE ONLY

Water Leakage Sensor

Dimensions



Specifications

Dimensions
 70.8mmx66.7mmx19mm

Colour
 White

Weight
 64g

Communication
 ZigBee 3.0 HA

Battery Voltage
 3V

Battery Cell
 LR03 AAA (2pcs)

Battery Life
 Up to 5 years

Rated Power
 ≤ 90 mW

Maximum Transmitted Power
 ≤ 5 dBm

Ambient Temperature
 -10° - +50°C

Frequency Band
 2405-2480 MHz

Check with your local government for instruction on disposal of these products.

Wall/Ceiling Wireless Sensor SED-MTH-G-5045

Dimensions

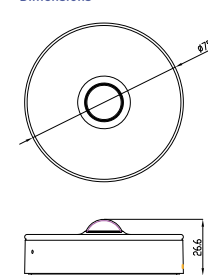

Specifications

Dimensions
 70mm diam. x 26.6mm

Colour
 White

Weight
 59g

Communication
 ZigBee 3.0 HA

Detection Range
 Ceiling:
 Ø4m (installation height 2.5m)
 Wall:
 R5m (installation height 1.2m)

Battery Voltage
 3V

Battery Cell
 LR03 AAA (2pcs)

Battery Life
 Up to 5 years

Ambient Temperature
 -10° - +50°C

Check with your local government for instruction on disposal of these products.

Door/Window Wireless Sensor SED-WDC-G-5045

Dimensions

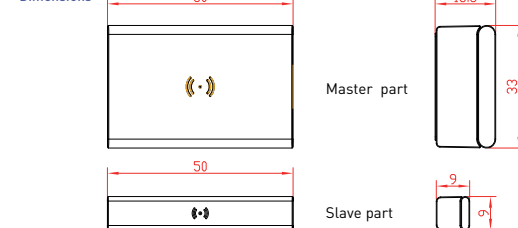

Specifications

Dimensions
 Master part: 50mmx33mmx16.3mm Slave part: 50mmx9mmx9mm

Colour
 White/transp.

Weight
 30g

Communication
 ZigBee 3.0 HA

Detection Range
 Trigger "close": wood 30mm, metal 18mm
 Trigger "open": wood 32mm, metal 20mm

Battery Voltage
 3V

Battery Cell
 CR2450

Battery Life
 Up to 5 years

Ambient Temperature
 -10° - +50°C

Check with your local government for instruction on disposal of these products.

CO₂ Sensor SED-CO₂-G-5045

Dimensions

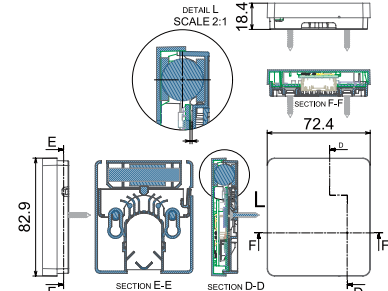

Specifications

Dimensions
 3.26in x 2.85in x 0.72in
 82.9 mm x 72.4 mm x 18.4 mm

Operating Temperature
 0°C to 50°C (32°F to 122°F)

Temperature Accuracy
 ±0.3°C (0.54 °F) typical within operating range

Humidity Range
 0% to 100%

Humidity Accuracy
 ± 3% RH (typical within 0% to 80% RH)

Measurement Range
 0 to 5000 ppm

Measurement/Transmission Intervals
 2.5 minutes (day), 10 minutes (evening)
 Note: Battery life will be reduced should interval be shortened (i.e. using remote temperature/humidity functions)

CO₂ Accuracy at NTP
 ±60ppm +3% of reading (400 - 2,000ppm range)

Communication
 Zigbee 3.0 Green Power (encrypted, bi-directional)

Battery Voltage
 3.6 V

Battery Cell
 AA Lithium ion

Battery Life
 10+ years (non-replaceable)
 Note: Battery life can be reduced when sensor is operated at temperatures approaching the operating limits.
 -30°C to 70°C

Check with your local government for instruction on disposal of these products.

SE8350**

Dimensions

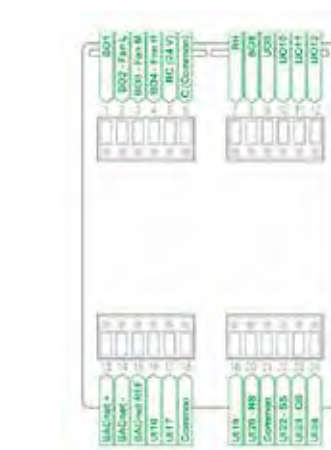
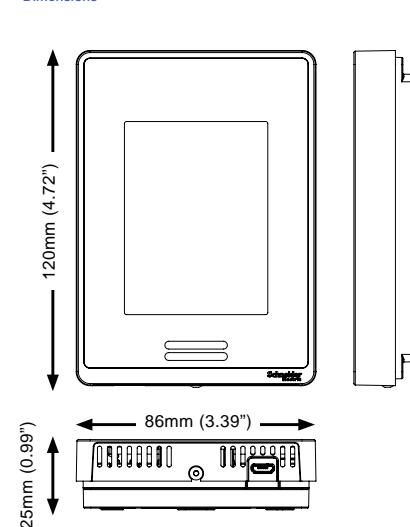

Main Specifications

Item	Description
Dimensions	12cm/4.72in (H) x 8.6cm/3.38in (W) x 2.5cm/1in (D)
Power Requirements	Input: 24VAC ±15% recommended, Absolute Max 29.5VAC, 50/60Hz or 24Vdc ±15% Peak device consumption: up to 6VA with CO ₂ sensor or Wi-Fi module Plus Output Load (max total 94VA) Transformer maximum rating: 100VA, 4.17 A
Output Ratings	Nine Electronic Relays : 24VAC or 24Vdc ±15% same as input power 1.0 Amp, in-rush = 3.0 Amps; Four Analog Outputs : 0 - 10 Vdc, 5mA maximum, (2 kilo-ohm resistance) Configurable Output Analog/Electronic Relay
Operating Conditions	0 °C to 50 °C (32 °F to 122 °F) 0% to 95% R.H. non-condensing
Storage Conditions	-30 °C to 50 °C (-22 °F to 122 °F) 0% to 95% R.H. non-condensing
Temperature Sensor	Local 10 K NTC type 2 thermistor
Temperature Sensor Resolution	± 0.1 °C (± 0.2 °F)
Temperature Control Accuracy	±0.5 °C (± 0.9 °F) @ 21 °C (70 °F) typical
Humidity Sensor Precision	Reading range from 10-90 % R.H. non-condensing 10 to 20% precision: 10% 20% to 70% precision: 5% 70% to 90% precision: 10%
Humidity Sensor Stability	Less than 0.25 % yearly (typical drift)
Dehumidification Setpoint Range	30% to 95% R.H.
Occ, Unocc and Standby Cooling Setpoint Range	12.0 °C to 37.5 °C (54 °F to 100 °F)
Occ, Unocc and Standby Heating Setpoint Range	4.5 °C to 32 °C (40 °F to 90 °F)
Room and Outdoor Air Temperature Display Range	-40 °C to 50 °C (-40 °F to 122 °F)
Proportional Band for Room Temperature Control	Cooling and Heating: Default: 1.8°C (3.2°F)
Analog Inputs	Modulating 0-10 VDC across UI19, UI24 to Common
Binary Inputs	Dry contact across terminals UI16, UI17 to Common
Remote Temperature Sensor	10 K NTC type 2 thermistor UI20, UI22, UI23
Wire Gauge	Power supply: 16 or 18 gauge Communications: 22 gauge typical, 24 gauge minimum
Shipping Weight	0.34 kg (0.75 lb)

** SE8350 does not connect directly to the air conditioner itself

Hotel Room Controller HRC**

Dimensions

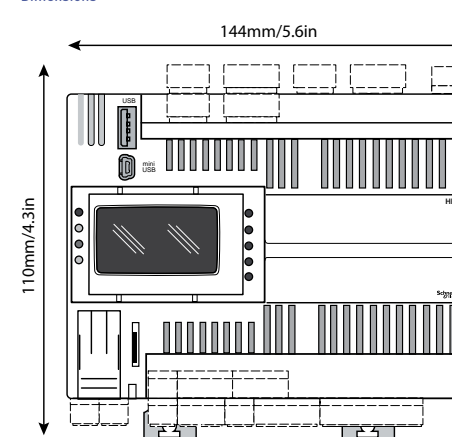

Specifications

Dimensions
 5.6in x 4.3in x 2.4in
 144mm x 110mm x 60.5mm

Digital Inputs
 12

High Voltage Relay
 10 x 3 A SPST +250 VAC relays

Analog Inputs
 12 x configurable analog inputs
 DI: voltage free DI, 10 kΩ input impedance
 0-20mA: range 0, 1000, < 150 Ω impedance
 0-10V: range 0, 1000 > 10 kΩ impedance
 6 x 0-10 V outputs. Load impedance > 700 Ω

Analog Outputs
 24 VAC + 10% NOT ISOLATED
 +20...38 Vdc NOT ISOLATED

Supply Frequency
 50/60 Hz

Power Cycle
 35 VA / 15 W

Operating Temperature
 -20 to 60 °C (-4 to 140 °F) conforming to UL 60730-1

Storage Temperature
 -30 to 70 °C (-22 to 158 °F)

Certification

Check with your local government for instruction on disposal of these products.

** Available through a Schneider Electric distribution channel.

Panasonic AC Smart Cloud

With Panasonic AC Smart Cloud, have your business under control, and start saving!



Key functions and uniqueness

Multi site monitoring

- It doesn't matter how many sites you have, easy to manage, operate, compare sites, locations, rooms.



Schedule setting

- Yearly / weekly / holiday timer setting as you want



Powerful statistics for energy savings

- Power consumption, capacity, efficiency level can be compared with different parameters (Yearly / monthly / weekly / daily bases)



Maintenance notification

- Error notification by email and with floor layout
- Maintenance notification of PAC / VRF outdoor units
- Remote service checker function

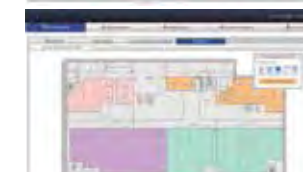

User customisation*2

Site administrator can create users as desired and assign customised profiles.

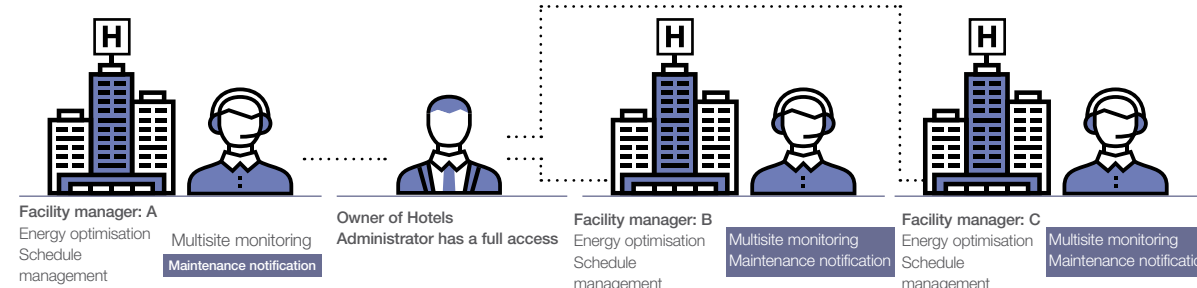

Flexible and scalable solution

- Energy saving
- Zero downtime
- Site(s) management

Centralise control of your business premises, from wherever you are, 24/7/365. It doesn't matter how many sites you have, or where they are! The AC Smart Cloud system from Panasonic allows you to have complete control of all your installations, from your tablet or from your computer. In a simple click, all your units from several locations, receive status updates in real-time of all your installations, preventing breakdowns and optimising costs.

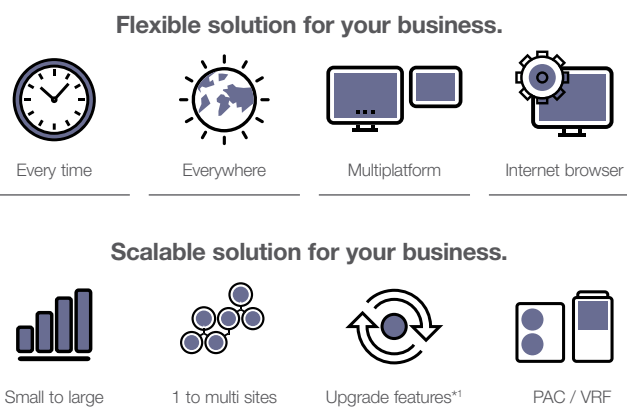

*1 Customised to meet user demand / Continuous upgrades: new functions and product introductions / IT smart management.

Panasonic AC Smart Cloud offers continuous improvement always thinking about users

New e-CUT function

E-CUT functions are newly available in Panasonic AC Smart Cloud. 5 energy saving settings reduces automatically its energy consumption.

1. Set temperature auto return. When you want to return to the set temperature after a certain time even if the temperature is changed.
2. Unattended auto shut OFF. When you want to operate outside of a schedule but to monitor and stop automatically.
3. Set temperature range limit. When you want to limit the temperatures that can be set.
4. Energy saving timer / Efficient operation setting. Specify time slots when you want operation capacity reduced.
5. Demand / peak shaving settings/ Peak cut settings. Specify time slots when you want operation capacity of the outdoor units reduced.

Main functions per user type

Function / Main Tab	Sub-Tab	Basic type (Eg.: Owners, facility managers)	Professional type (Eg.: Installers, maintenance companies)
AC setting	I_U / O_U operation details	✓	✓
	Cloud adapter (CZ-CFUSCC1) details	✓	✓
	AC maintenance	✓	✓
	Map view	✓	✓
Energy saving function	NEW e-CUT	✓	✓
	Yearly, weekly schedule setting / view	✓	✓
Schedule	Power consumption	✓	✓
	Capacity	✓	✓
Powerful statistics	Efficiency ranking	✓	✓

Function / Main Tab	Sub-Tab	Basic type (Eg.: Owners, facility managers)	Professional type (Eg.: Installers, maintenance companies)
Maintenance function	Notification overview / details	✓	✓
	Maintenance settings	✓	✓
	Map view	✓	✓
	Remote service checker	✓	✓
User account *2	New / update user registration	✓	✓
	Distribution group overview / details	✓	✓
System setting	Cut OFF request	✓	✓
	Map editor	✓	✓

*2 Cloud service fee is additionally required. Please contact an authorised Panasonic dealer.

Remote service checker function

- Zero down time**
 - Quick analysis & response
 - Time & Cost saving for service maintenance task

Recording service checker parameters from wherever you are!

- Data duration: Maximum 120 minutes
- Data frequency: 10 – 90 seconds
- Mode selection: With test run or Without test run
- Count down schedule setting available

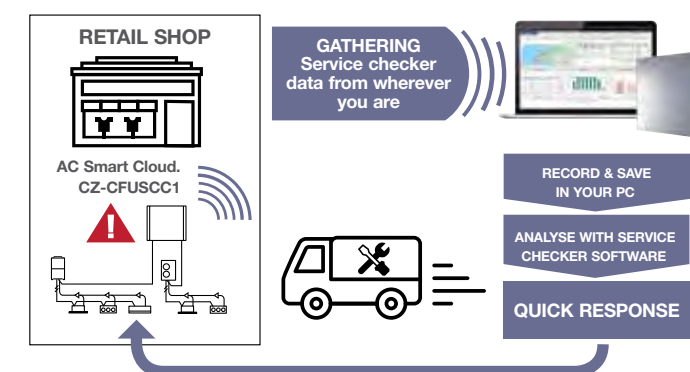

Panasonic AC Smart Cloud parts lists

CZ-CFUSCC1 AC Smart Cloud communication adaptor. Up to 128 groups. 128 units control

Note: Please contact an authorized Panasonic dealer.

Controllers

A wide variety of control options to meet the requirements of different applications.



Next Generation Control Solutions



WLAN Control







Smart Cloud Control









BMS Plug & Play

Note: Additional accessories or devices are required. Please consult Panasonic for details.

OPERATION SYSTEM	INDIVIDUAL CONTROL SYSTEMS				
	Requirements	Simplified high-spec operation	High-spec operation	Normal operation	Operation from anywhere in the room
External appearance					
Type, model name	Simplified high-spec Wired Remote Controller CZ-RTC6BL CZ-RTC6BLW	Deluxe Wired Remote Controller CZ-RTC5B	Timer Remote Controller (Wired) CZ-RTC4	Wireless Remote Controller Controller: CZ-RWS3 Receiver: CZ-RWRU3 CZ-RWRL3 CZ-RWRD3 CZ-RWRT3 CZ-RWRC3	Wired Remote Controller CZ-RD52CP
Built-in thermostat	●	●	●	—	—
nanoe™ X on/off control <small>*not applies to Floor Console</small>	●	●	—	●	—
ECONAVI on/off control	●	●	●	●	—
Number of indoor units which can be controlled	1 group, 8 units	1 group, 8 units	1 group, 8 units	1 group, 8 units	1 unit
Use limitations	<ul style="list-style-type: none"> CZ-RTC6BL : Up to 2 controllers can be connected per group(no combination possible with CZ-RTC6BL or CZ-RTC6BLW) CZ-RTC6BLW :Up to 1 controller can be connected per group 	<ul style="list-style-type: none"> Up to 2 controllers can be connected per group (When using ECONAVI sensor, only one remote controller is possible to connect at indoor unit) 	<ul style="list-style-type: none"> Up to 2 controllers can be connected per group. (When using ECONAVI sensor, only one remote controller is possible to connect at indoor unit) 	<ul style="list-style-type: none"> Up to 2 controllers can be connected per group. 	<ul style="list-style-type: none"> Only 1 controller for 1 indoor unit.
Function ON/OFF	●	●	●	●	●
Mode setting	●	●	●	●	●
Fan speed setting	●	●	●	●	●
Temperature setting	●	●	●	●	●
Air flow direction	●	●	●	● ^{*1}	●
Permit/Prohibit switching	—	—	—	—	—
Weekly program	● ^{*2}	●	●	—	—

^{*1} Setting is not possible when a remote controller unit is present (use the remote controller for setting).
^{*2} CZ-RTC6BL with H&C Control App, CZ-RTC6BLW with H&C Control App or Comfort Cloud App.
 Note: Product images not to scale.

CENTRALISED CONTROL SYSTEMS			SMART CONTROL SYSTEMS			
Requirements	Operation with various function from centre station	Only ON/OFF operation from centre station	Simplified load distribution ratio (LDR) for each tenant	Connection with 3rd Party Controller	Cloud connectivity, operation from anywhere	Schneider Electric room controller
External appearance						
Type, model name	System Controller CZ-64ESMC3	ON/OFF Controller CZ-ANC3	Intelligent Controller CZ-256ESMC3 (CZ-CFUNC2)	Seri-Para I/O unit for outdoor unit CZ-CAPDC2 Interface adaptor CZ-CAPC3 Seri-Para I/O unit for each indoor unit CZ-CAPBC2 Communication Adaptor CZ-CFUNC2 LonWorks Interface CZ-CLNC2	WLAN Smart Adaptor Comfort Cloud App CZ-TACG1 / CZ-CAPWFC1	PAC smart connectivity+ SER8150 (room controller)
Number of indoor units which can be controlled	64 groups, max. 64 units	16 groups, max. 64 units	64 units x 4 links, max. 256 units	1 adaptor : 1 group, 8 units. Multiple adaptors for each indoor units : 200 units(10 location x 20 units)	1 group, 8 units	1 group, 8 units
Use limitations	<ul style="list-style-type: none"> Up to 10 controllers, can be connected to one system. Main unit/sub unit (1 main unit + 1 sub unit) connection is possible. Use without remote controller is possible. 	<ul style="list-style-type: none"> Up to 8 controllers (4 main units + 4 sub units) can be connected to one system. Use without remote controller is impossible. 	<ul style="list-style-type: none"> A communication adaptor (CZ-CFUNC2) must be installed for three or more links. 	<ul style="list-style-type: none"> Mobile device, free App and internet router is required separately. Wired remote controller (master) required. 	<ul style="list-style-type: none"> Comparing to RTC5B, up to 1 controller can be connected per IDU. Wired to R1/R2. VRF and PAC(S-link) model only. 	
Function ON/OFF	●	●	●	●	●	●
Mode setting	●	—	●	●	●	●
Fan speed setting	●	—	●	●	●	●
Temperature setting	●	—	●	●	●	●
Air flow direction	● ^{*1}	—	● ^{*1}	●	●	●
Permit/Prohibit switching	●	●	●	—	—	—
Weekly program	●	—	●	●	—	—

Simplified high-spec wired remote controller (CZ-RTC6BL / CZ-RTC6BLW)



Dimensions
H 86 x W 86 x
D 25mm

CONEX

Deluxe wired remote controller (CZ-RTC5B)



Dimensions
H 120 x W 120 x
D 16 mm

	CZ-RTC6BL(W) + H&C CONTROL APP	CZ-RTC5B
Energy Saving		
ECONAVI on/off	●	●
Temperature Auto Return	●*1	●
Temperature Setting range	●*1	●
Auto Shutoff	●*1	●
Schedule peak cut	●*1	●
Repeat off timer	●*1	●
Basic Operation		
Individual Louver Control(Lock individual flap for 4-WAY cassette)	●*1	●
ON/OFF timer	●*1	●
Weekly timer	●*1	●
Filter information	●*1*2	●*2
Outing function	●	●
Quiet operation mode	●*1*2	●*2
Power consumption monitor	●*1*2	●*2
Energy saving	●*1*2	●*2
initial settings	—	●
Ventilation	●*1	●
nanoe™ X	●*1*2	●*2
Maintenance Function		
Outdoor unit error data	—	—
Service Contact address	●*1	—
RC setting mode	●	●
Test run	●	●
Sensor information	●*2	●*2
Service check	●	●
Simple/Detailed Settings	●	●
Auto address	●*3	●
Initial Settings		
Rotation operation	●*1	●
Backup operation	●*1	●
Support operation	●*1	●

*1 Only with H&C Control App *2 Subject to the connected model *3 Only with remote controller operation
Note: Product images not to scale.

New service checker interface



The new service checker interface provides easy access to service parameters and service checker data via Bluetooth®.

- A new service checker interface*4 for PAC NX Series
- Bluetooth® connection
- Panasonic H&C Diagnosis App

*4 Available as a spare part, compatible with new PAC NX Series.

Input voltage	220-240 V ~ 50-60 Hz (supplied from outdoor unit)
Power consumption	Maximum 2.4 W (including outdoor units)
Size (H x W x D)	175 x 125 x 50 mm
Weight	—
Interface	Bluetooth® 4.2 or later
Frequency range	2.4 GHz band
Operation range - Temperature / Humidity	0 ~ 40 °C / 20 ~ 80 % (no condensation)

* Frequency band in which the ratio equipment operates; 2402 - 2480 MHz.
* Maximum radio-frequency power transmitted in the frequency bands in which the ratio equipment operates; +0 dBm.

Individual Control Systems

Control contents	Part name, model No.	Quantity
Standard Control • Control of the various operations of the indoor unit by wired or wireless remote controller. • Cooling or heating mode of the outdoor unit is decided by the first priority of the remote controller.	Wired remotd controller CZ-RTC4 / CZ-RTC5B / CZ-RTC6BL / CZ-RTC6BLW Wireless remote controller + Receiver CZ-RWS3 (Wall Mounted / Mini Cassette) CZ-RWS3 + CZ-RWRU3 (4-WAY Cassette) CZ-RWS3 + CZ-RWRT3 (Under Ceiling) CZ-RWS3 + CZ-RWRC3 (All split type)	1 unit each
(1) Group control • Batch remote control on all indoor units. • Operation of all indoor cells in the same mode. • Up to 8 units can be connected. • The sensor is the body sensor, and thermostat ON/OFF setting in regard to the temperature set by the remote controller is possible for each indoor unit.	Wired remotd controller CZ-RTC4 / CZ-RTC5B / CZ-RTC6BL / CZ-RTC6BLW Wireless remote controller + Receiver CZ-RWS3 (Wall Mounted / Mini Cassette) CZ-RWS3 + CZ-RWRU3 (4-WAY Cassette) CZ-RWS3 + CZ-RWRT3 (Under Ceiling) CZ-RWS3 + CZ-RWRC3 (All split type)	As required
(2) Main/sub remote control • Max 2 remote controllers per indoor unit. (Main remote controller can be connected) • The button pressed last has priority. • Timer setting is possible even with the sub remote controller. When using ECONAVI sensor, only one remote controller is possible to connect at indoor unit.	Main or sub Wired remotd controller CZ-RTC4 / CZ-RTC5B / CZ-RTC6BL Wireless remote controller + Receiver CZ-RWS3 (Wall Mounted / Mini Cassette) CZ-RWS3 + CZ-RWRU3 (4-WAY Cassette) CZ-RWS3 + CZ-RWRT3 (Under Ceiling) CZ-RWS3 + CZ-RWRC3 (All split type)	As required

SYSTEM EXAMPLE

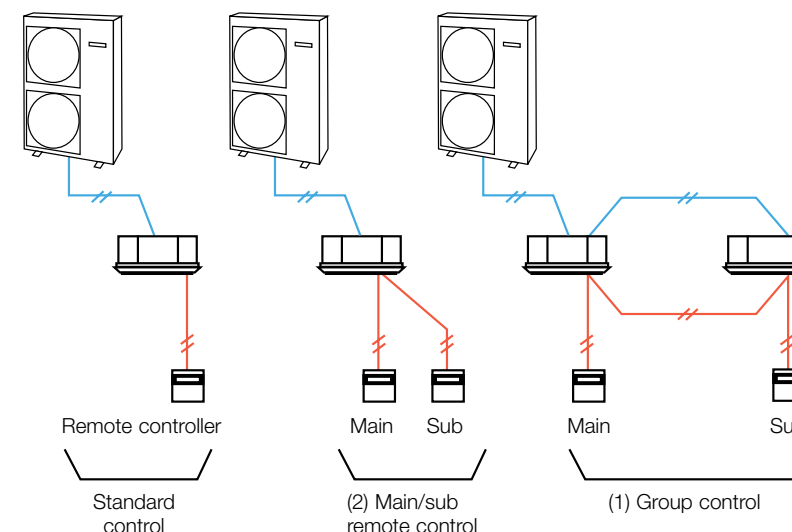

Note: Connectable number of controllers, controller combination, connectable indoor units, remote control maximum wiring length are different between the controller. Please confirm the Installation Instructions of controller or consult with Panasonic service center.

New wired RC & Monitor adaptor & App compatibility*1

*1 End User App Recommendation
CZ-RTC6BL - H&C Control App
CZ-RTC6BLW - Comfort Cloud App

			Wired RC BLUETOOTH CZ-RTC6BL Bluetooth	Wired RC BLUETOOTH & WLAN CZ-RTC6BLW Bluetooth	WLAN adaptor CZ-CAPWFC1	Monitor adaptor for diagnosis New service checker Bluetooth
PZH2 / PZ2 series			✓	✗	✓	✗
NX series	PZH3 / PZ3 Series ODU ✗ NX series IDU		✓	✓	✓	✓
	PZH2 / PZ2 series ODU ✗ NX series IDU		✓	✓	✓	✗

Note: Power supply is available only when using NX IDU

Timer remote controller (CZ-RTC4)



Dimensions
H 120 x W 120 x D 20 mm

Basic remote controller ON/OFF

- Operation mode changeover (Cooling, Heating, Dry, Auto, Fan).
- Temperature setting (Cooling / Dry: 18-30 °C Heating: 16-30 °C).
- Fan speed setting H / M / L and Auto.
- Air flow direction adjustment.
- ECONAVI on / off*2

Time Function 24 hours real time clock

- Day of the week indicator.

Weekly Programme Function

- A maximum of 6 settings/day and 42 settings/week can be programmed.

Outing Function

- This function can prevent the room temperature from dropping or rising when the occupants are out for a long time.

Sleeping Function

- This function controls the room temperature for comfortable sleeping.

Maximum 8 indoor units can be controlled from one remote controller

Remote control by main remote controller and sub controller is possible

Maximum 2 remote controllers (main remote controller and sub controller) can be installed for one indoor unit.

*2 Depending on the model, some menus cannot be used.

Note: Product images not to scale.

Wireless remote controller



For 4-WAY Cassette type
CZ-RWS3
+CZ-RWRC3



For all Ducted types
CZ-RWS3
+CZ-RWRC3



For Under Ceiling type
CZ-RWS3
+CZ-RWRT3

Remote control by main remote controller and sub controller is possible

- Maximum 2 remote controllers (main remote controller and sub controller) can be installed for one indoor unit.

When CZ-RWS3+CZ-RWRC3 is used, wireless control becomes possible for all indoor units

- When a separate receiver is set up in a different room, control from that room also becomes possible.
- Automatic operation by means of the emergency operation button is possible even when the remote controller has been lost or the batteries have been exhausted.

In addition, there are other functions such as temperature setting, operation switching, wind direction/fan speed setting, etc

Ventilation independent operation is possible

When commercial ventilation fans or heat-exchange ventilation fans have been installed, they can be operated with this remote control (interlocked operation with the indoor unit or independent ventilation ON/OFF).

Wired remote controller (CZ-RD52CP)



Note: Product images not to scale.

T10 Terminal for External Control (Digital Connection)

Connecting an indoor unit to an external device is easy. The T10 Terminal featured in the electronic circuit board of all indoor units enables digital connection to external devices.



1. T10 Terminal Specification (T10:CN061 at indoor unit PCB)

- Control items: 1. Start/stop input
2. Remote controller prohibit input
3. Start signal output
4. Alarm signal output

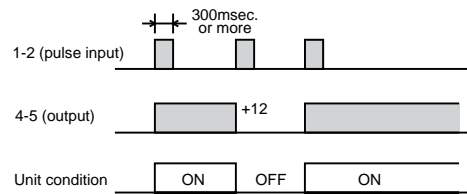

NOTE: The wire length from indoor unit to the Relay must be within 2.0m. Pulse signal changeable to static with JP cutting. (Refer to JP001)

Example of wiring

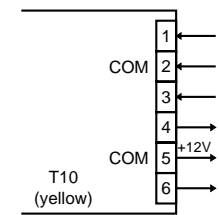

Condition

- 1-2 (Pulse input): Unit ON/OFF condition switching with a pulse signal. (1 pulse signal: shortage status more than 300msec.or more)
- 2-3 (Static input): Open/ Operation with Remote is permitted.(Normal condition) Close/ Remote controller is prohibited.
- 3-4-5 (Static output): 12V output during the unit ON. / No output at OFF.
- 4-5-6 (Static output): 12V output when some errors occur / No output at normal.

2. Usage Example

Forced OFF control

Condition

1-2 (Static input): Close/ Operation with Remote is permitted. (Normal condition) Open/ Unit is forcibly OFF and Remote controller operation is prohibited.

Example of wiring

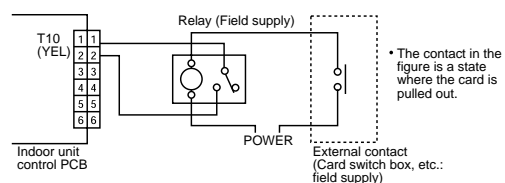

Note: The wire length from indoor unit to the Relay must be within 2.0m

Operation ON/OFF signal output

Condition

4-5 (Static output): 12V output during the unit ON / No output at OFF

Example of wiring

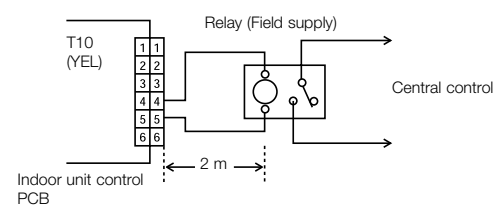

Note: The wire length from indoor unit to the Relay must be within 2.0m. Pulse signal changeable to static with JP cutting. (Refer to JP001)



Reducing inefficient air conditioning

Providing outstanding energy-saving performance, Panasonic's large capacity air conditioners can be connected to ECONAVI to detect when energy is being wasted.

ECONAVI senses the presence or absence of people and the level of activity in each area of a room. When unnecessary heating or cooling is detected, indoor units are individually controlled to match room conditions for energy-saving operation.



ECONAVI Sensor CZ-CENSC1

• please check specific models for compatibility

How 2 sensors work for human detection



Detection of the level of activity enables optimum power saving

Presence or absence of people and the level of activity in the room are detected in real time. Set temperature is automatically adjusted to optimise the power consumption.



Sensors are remotely located to maximise the energy-saving effect

When sensors are built into the indoor unit, pillars, walls, cabinets and other fittings can obstruct the sensors, reducing the area of detection and lowering the energy-saving effect. Panasonic sensors can be located any where in the room which enables the optimum layout for sensors in any location.

Case study at coffee shop



In the morning
Reduced cooling when there are fewer people.



In the afternoon
Thorough cooling when there is a high level of activity.



At night
Automatic Thermo Off depending on conditions at the end of the day.

Wide detection area

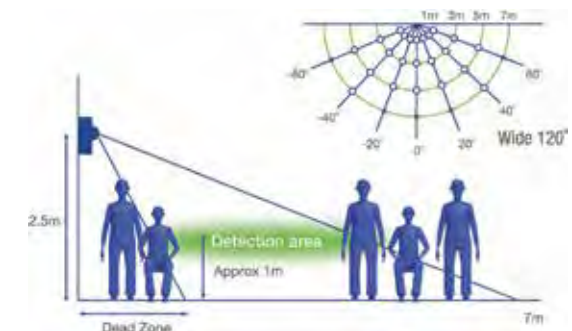

A sensor is remotely set to maximise the detection area.

Installation flexibility for indoor unit layout changes.

Remote Controller External Dimensions

SIMPLIFIED HIGH-SPEC WIRED REMOTE CONTROLLER (CZ-RTC6BL / CZ-RTC6BLW)

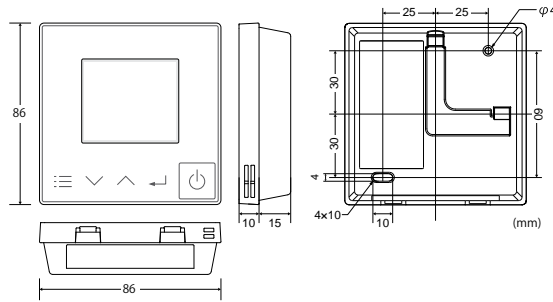

DELUXE WIRED REMOTE CONTROLLER (CZ-RTC5B)

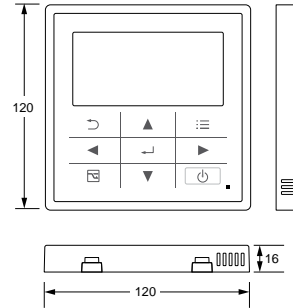

TIMER REMOTE CONTROLLER (CZ-RTC4)

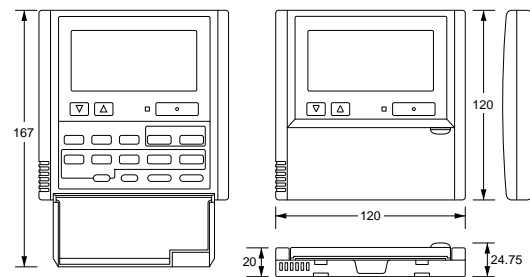

WIRELESS REMOTE CONTROLLER (CZ-RWS3)

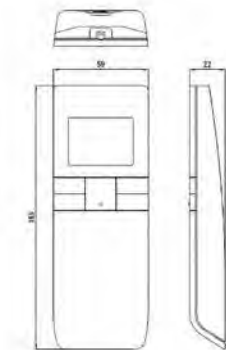

SEPARATE RECEIVER FOR WIRELESS REMOTE CONTROLLER (CZ-RWRC3)

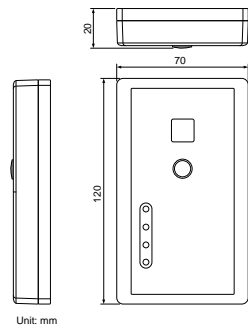

REMOTE SENSOR (CZ-CSRC3)

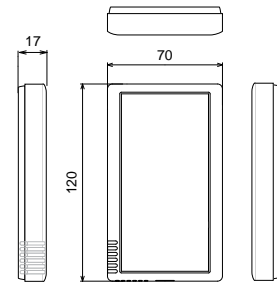

ECONAVI SENSOR (CZ-CENSC1)

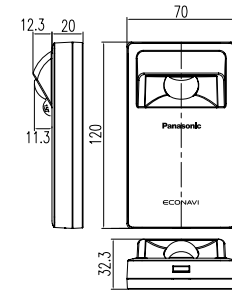

SYSTEM CONTROLLER (CZ-64ESMC3)

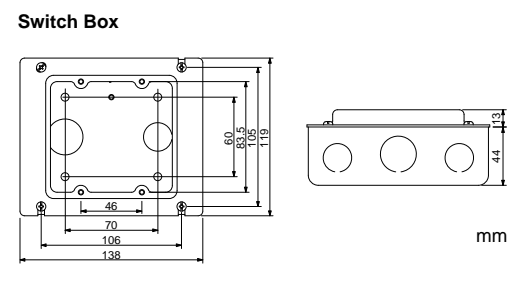
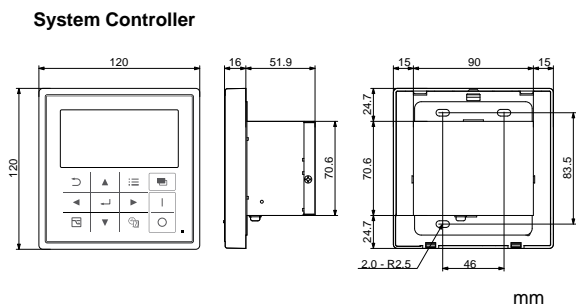

Remote Controller External Dimensions

COMMUNICATION ADAPTOR (CZ-CFUNC2)

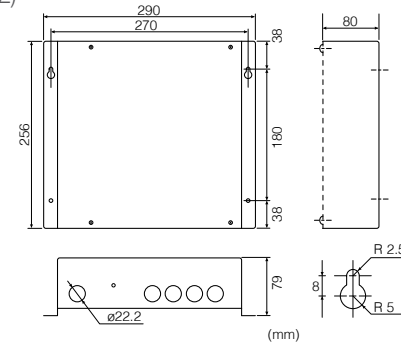

INTELLIGENT CONTROLLER (CZ-256ESMC3)

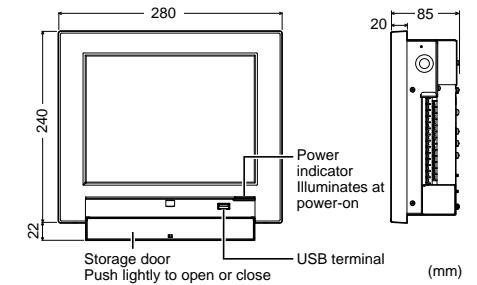

ON/OFF CONTROLLER (CZ-ANC3)

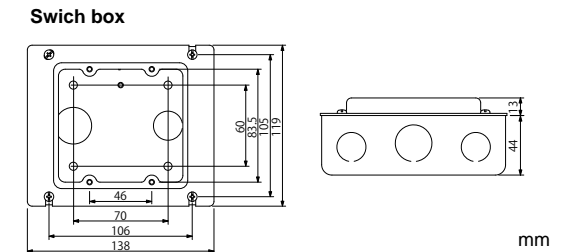
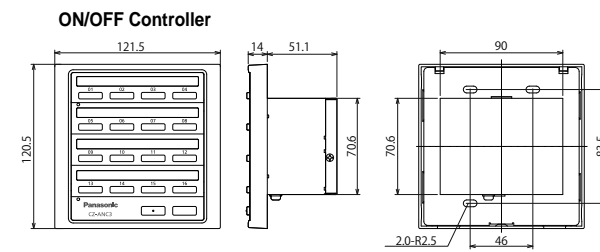

SERI-PARA I/O UNIT FOR EACH INDOOR UNIT (CZ-CAPBC2)

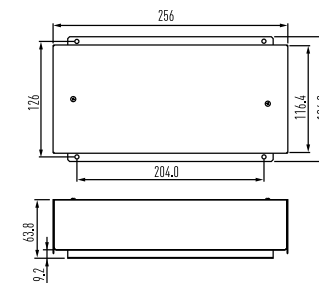

WIRED REMOTE CONTROLLER FOR RESIDENTIAL MODEL (CZ-RD52CP)

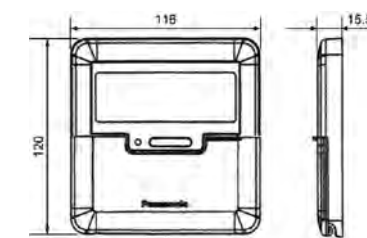

SERI-PARA I/O UNIT FOR OUTDOOR UNIT (CZ-CAPDC2)

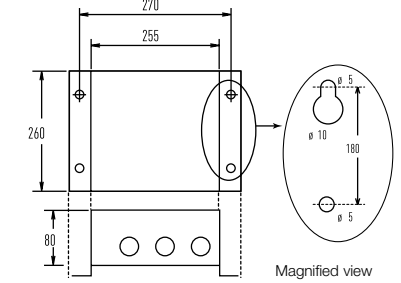

WLAN ADAPTOR (CZ-TACG1)

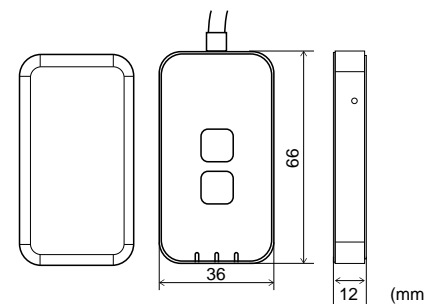

WLAN ADAPTOR (CZ-CAPWFC1)

