

DAIKIN

PCVAU1809B

VRV

Heat Pump / Heat Recovery 50 Hz

R-410A

Next generation **VRV** system featuring VRT now with Airside Control



First launched in Japan in 1982, the Daikin **VRV** system has been embraced by world markets for over 35 years. Now, Daikin proudly introduces the new **VRV H** and **R** series. By uniting advanced software and hardware technologies, **VRV H** series / **R** series is able to attain greater heights in energy savings and comfort.

VRV
H SERIES / R SERIES

Contents

New Products Information	3	
History of VRV development	5	
VRV User Benefits	7	
VRV Overview	9	
VRV H Series	13	
VRV R Series	31	
VRV IV S Series	53	
VRV IV Q Series	63	
VRV IV W Series	81	
VRV WS Series	105	
Indoor Unit Overview	111	
VRV Indoor Units	Type	
FXFSQ-A	Ceiling Mounted Cassette (Round Flow with Sensing)	113
FXFQ-P	Ceiling Mounted Cassette (Round Flow)	123
FXZQ-A2	Ceiling Mounted Cassette (Compact Multi Flow)	125
FXUQ-A	4-Way Flow Ceiling Suspended	126
FXCQ-A	Ceiling Mounted Cassette (Double Flow)	127
FXEQ-A	Ceiling Mounted Cassette (Single Flow)	129
FXDQ-T	Slim Ceiling Mounted Duct (Compact Series)	131
FXDQ-PD/ND	Slim Ceiling Mounted Duct (Standard Series)	133
FXDQ-MA	Ceiling Concealed Duct	134
FXSQ-PA	Middle Static Pressure Ceiling Mounted Duct	135
FXMQ-P(A)	Ceiling Mounted Duct	137
FXHQ-MA / A	Ceiling Suspended	139
FXAQ-A	Wall Mounted	141
FXLQ-MA	Floor Standing	143
FXNQ-MA	Concealed Floor Standing	144
Residential Indoor Units	Type	
FFQ-B	Ceiling Mounted Cassette (Compact Multi Flow)	145
FDXS-C	Slim Ceiling Mounted Duct	147
FTXS-K(A)	Wall Mounted	148
Branch Provider Units / Branch Selector Units	149	
Air Handling Unit	151	
Air Treatment Equipment Lineup	153	
Outdoor Air Processing Unit	155	
Heat Reclaim Ventilator with DX-Coil and Humidifier	159	
Heat Reclaim Ventilator	163	
Control Systems	171	
Option List	185	
Daikin Engineering Supports	197	

New Products Information

Ceiling Mounted Cassette (Double Flow) Type P.128

Stylish unit blends easily with any interior.



FXCQ-A



- This model features a stylish flat panel with fresh white colour for a new sophisticated appearance.
- Airflow direction can be individually adjusted for each air discharge outlet to deliver optimal air distribution.
- Control of airflow rate has been improved from 3-step to 5-step. Auto airflow rate is newly available.

Position 0
(Fixed airflow to highest position)

Swing
(Up / Down)

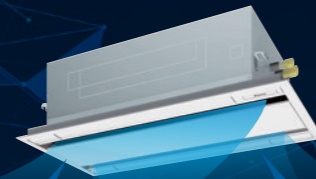

Ceiling Suspended Type P.139

New 125 / 140 models provide greater capacity for large spaces



FXHQ-A



- The technology of the DC fan motor, wide sirocco fan, and large heat exchanger combine for greater airflow and quiet operation.
- Control of airflow rate has been improved from 2-step to 3-step.

• Suitable for high ceilings

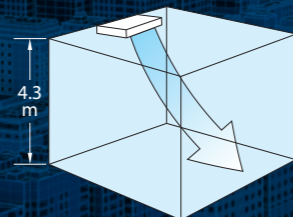

Wall Mounted Type P.141

Stylish flat panel design harmonised with your interior décor



FXAQ-A

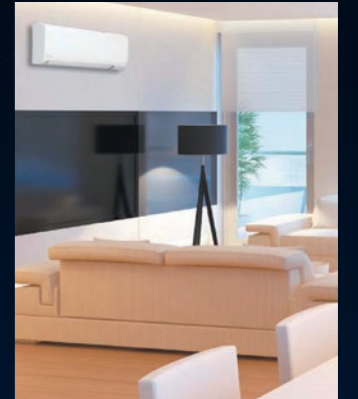

- Higher airflow is achieved to enhance comfort.

- Whisper quiet in operation, with sound levels as low as 28.5 dB(A).

Simplified Remote Controller P.173

Easy operation with new intuitive design

Using only six buttons, users have direct access to basic functions. This enables them to easily set comfort to their preference.



Operation mode selection

Airflow rate (Fan speed)

ON/OFF button

Temperature setting (+/-)

Airflow direction



BRC2E61

History of VRV development

The 1st Generation

VRV series released in 1982

<The birth of innovative products that changed the history of air conditioning technology>



- 2.5-year development term
- Completion of development in May, 1982
- Technical award of Japan Society of Refrigerating & Air-conditioning Engineers in 1983

Development history

To meet the needs of the times, we've been continuously developing technologies as the leading air conditioning manufacturer in the world.

Expansion of the country of sale

Sales is undergoing in more than 70 countries

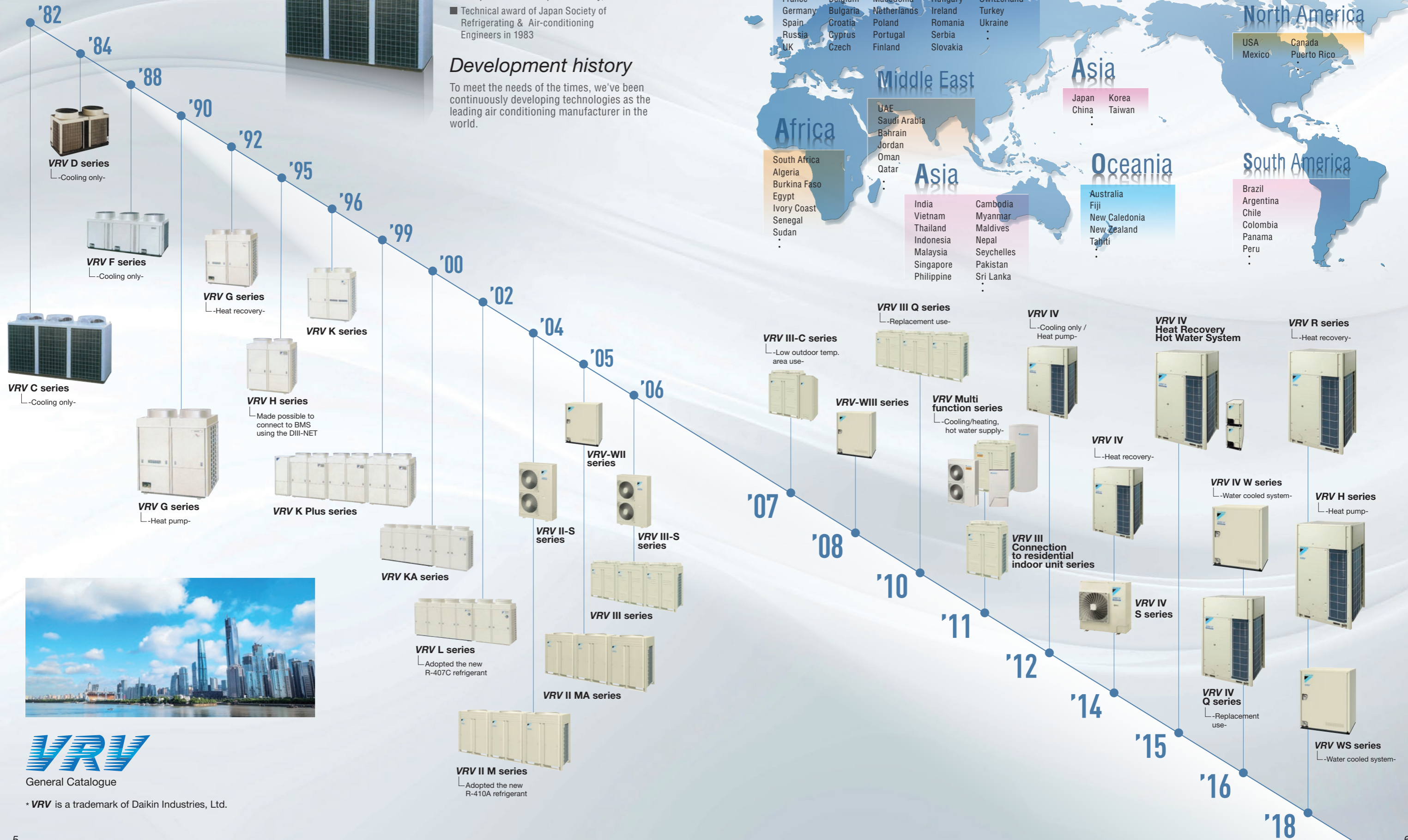
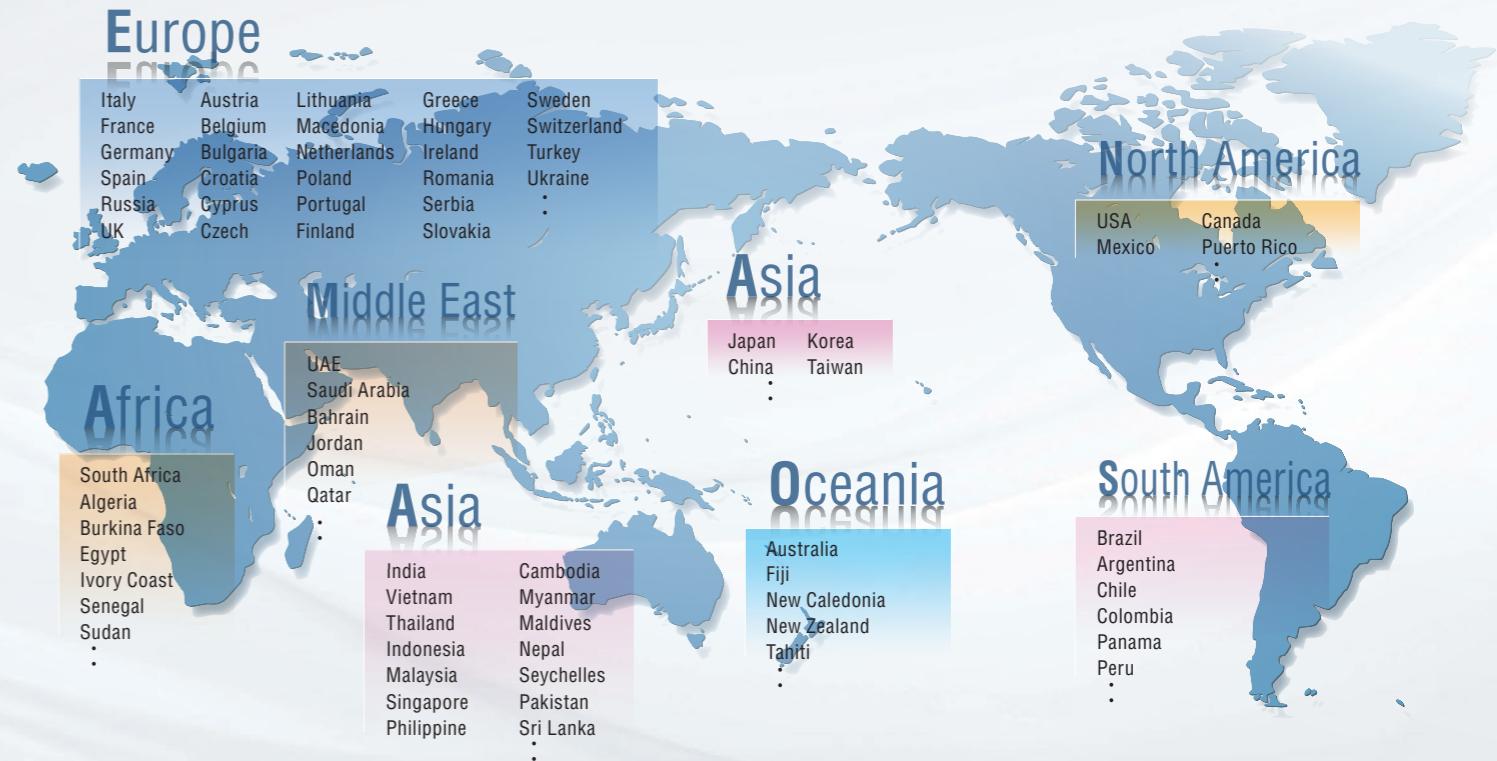

General Catalogue
 • VRV is a trademark of Daikin Industries, Ltd.

VRV User Benefits

For property OWNERS

First launched in 1982, the Daikin VRV system has been providing comfort and reliability to building owners and their tenants for over 35 years. Leveraging the latest in energy-saving technology, Daikin has further improved energy savings while reducing space requirements. This added value is one reason why Daikin is the right choice for building owners.

Energy saving & comfortable environment

Based on the idea of using only as much space as absolutely required, Daikin first launched its commercial multi-split air conditioning systems in 1982. Since then, customers have benefitted from much increased energy efficiency. Now, our revolutionary new systems dramatically reduce energy with VRT Smart Control. During operating periods, control programs ensure thermal loading is generally low, thus boosting energy efficiency. This greatly reduces the amount of energy required for building air conditioning.



While optimally operating at low load, it maintains a comfortable indoor environment.

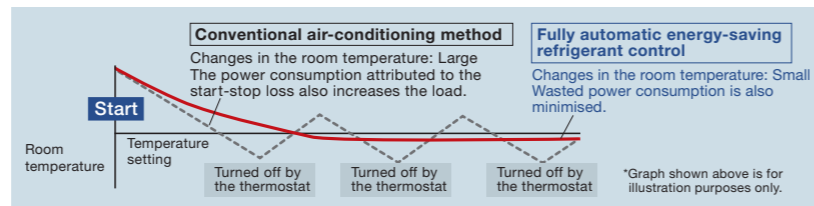

Efficient space utilisation

Daikin VRV system can be used to develop a large-scale air conditioning system on a single refrigerant system, thus reducing the space required for air conditioning equipment. Because the difference in height between the indoor and the outdoor unit can be as large as 90 m, even with a 20-storey building all of the outdoor units can be placed on the rooftop for more efficient utilisation of space.

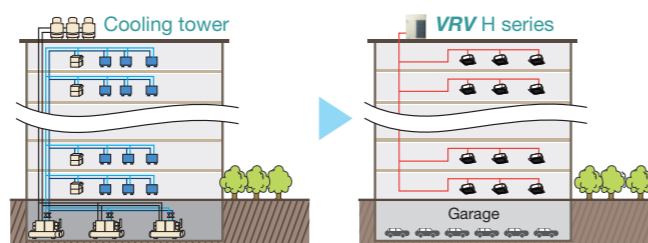

High reliability

Double backup operation

Daikin VRV outdoor unit goes beyond just highly reliable compressors with a backup system that ensures continued operation.

Unit backup

Should one outdoor unit in a multiple unit system fail, the other outdoor units switch to emergency operation. If for some reason a failure occurs, the system for that unit does not completely stop, and air conditioning is maintained.

Compressor backup

Since units are equipped with two compressors, even if one compressor fails, the other compressor carries on in emergency mode.

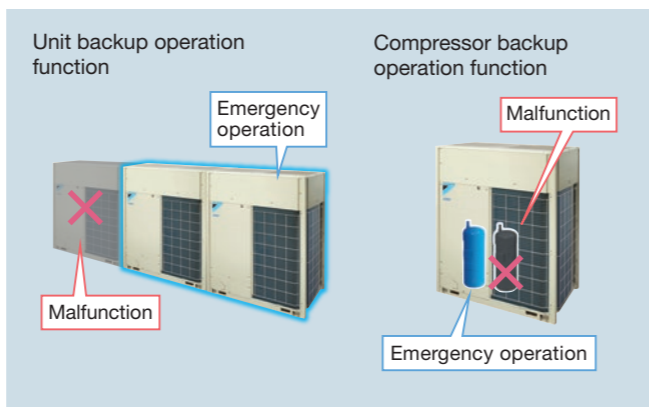

For USERS

Comfortable environment

While operating optimally at low load, VRT smart operation maintains the indoor temperature and ensures a comfortable environment.



Residential indoor units

Because indoor units developed for residential use can be connected, it is possible to realise quiet operation. You can include indoor units that operate at min. 22 dB(A), and to reduce the noise of refrigerant passing through the piping by remotely installing an BP unit.

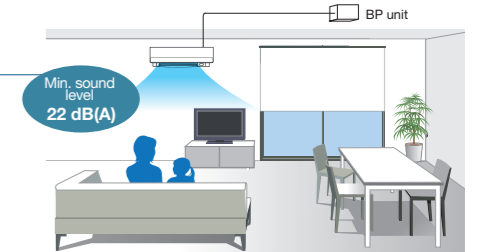

For CONSULTANT and DESIGN OFFICES

Varied lineup of models

System applications range from family residences to large commercial buildings. With various types of indoor units available, comfortable airflow is ensured in every space.

Long piping provides more flexible system design

Greater design freedom is provided because equivalent piping between indoor and outdoor unit can run as large as 190 m and reach a maximum height difference of 90 m.

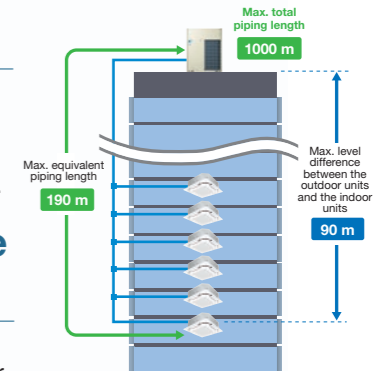

Compatible with engineering software

We at Daikin provide the software, the simulation results, and drawing materials to support the business-information modeling (BIM) currently entering the mainstream in construction industries.

Energy efficient

Daikin's innovative energy-saving technology helps you to achieve your green building solution.



For INSTALLERS

Lightweight and compact large-capacity single units

Systems can be configured with single modules providing up to 20 class. The lightweight and compact bodies are both easy to install and can be transported in elevators.



Simple piping, easy wiring

The REFNET piping system and DIII-NET system simplify refrigerant piping and control wiring installation.

Wide variety of series models to supply total air solutions

From residential houses to large buildings, and from newly constructed to renovated buildings, **VRV** system meets a wide range of air conditioning needs and supplies total air solutions.

VRV H SERIES

P.13

Heat Pump



RXYQ-A

Lineup

class	6	8	10	12	14	16	18	20	22	24	26	28	30	32	34	36	38	40	42	44	46	48	50	52	54	56	58	60	
High-COP Type				●	●	●	●	●	●	●	●	●	●	●	●	●	●	●	●	●	●	●	●	●	●	●	●	●	●
Standard Type	●	●	●	●	●	●	●	●	●	●	●	●	●	●	●	●	●	●	●	●	●	●	●	●	●	●	●	●	●

3-phase 4-wire system, 380-415 V/380 V, 50/60 Hz

Saves space and delivers excellent performance

The **VRV H** series achieves high efficiency in a design that is more compact and lightweight. It also offers comfort, easy installation, and high reliability to meet the needs in various buildings.

VRV R SERIES

P.31

Heat Recovery



REYQ-TA

Lineup

class	6	8	10	12	14	16	18	20	22	24	26	28	30	32	34	36	38	40	42	44	46	48	50	52	54	56	58	60	
High-COP Type				●	●	●	●	●	●	●	●	●	●	●	●	●	●	●	●	●	●	●	●	●	●	●	●	●	●
Standard Type	●	●	●	●	●	●	●	●	●	●	●	●	●	●	●	●	●	●	●	●	●	●	●	●	●	●	●	●	●

3-phase 4-wire system, 380-415 V, 50 Hz

Maximum comfort via simultaneous cooling and heating

The **VRV R** series enables simultaneous operation of cooling and heating within a single refrigerant piping circuit by controlling the BS unit. This series also substantially improves energy efficiency by recycling exhaust heat.

VRV IV S SERIES

P.53

Heat Pump



RXYMQ-A

Lineup

class	3.5	4	5	6	8	9
Heat Pump	●	●	●	●	●	●

3.5-6 class 1-phase, 220-230 V/220 V, 50/60 Hz

8-9 class 3-phase, 380-415 V, 50 Hz

Especially designed for residential houses, small offices and shops

VRV IV S series is the system that aims to provide sufficient capacity, along with the compact size required by residential houses, small offices and shops. Outdoor units are designed to be slim and space saving, and offer 6 models to select from, providing the power that suits your needs.

VRV IV Q SERIES

P.63

Heat Pump



VRV IV Q series Heat Pump RQYQ-T

3-phase 4-wire system, 380-415 V, 50 Hz



VRV III Q series Heat Recovery RQCEQ-P

3-phase 4-wire system, 380-415 V, 50 Hz

Lineup

		class	6	8	10	12	13	14	16	18	20	22	24	26	28	30	32	34	36	38	40	42	44	46	48	
VRV IV Q series	Heat Pump	Standard Type	●	●	●	●	●	●	●	●	●	●	●	●	●	●	●	●	●	●	●	●	●	●	●	●
		Space Saving Type								●	●	●	●	●	●	●	●	●	●	●	●	●	●	●	●	●
VRV III Q series	Heat Recovery		●	●	●	●	●	●	●	●	●	●	●	●	●	●	●	●	●	●	●	●	●	●	●	●

For quick & high quality replacement use

VRV IV Q series/VRV III Q series, a replacement **VRV** unit, can be installed using existing refrigerant piping, so renovation of the air conditioning system can be carried out quickly and smoothly. This minimises inconveniences to activities and users in the building.

VRV IV W SERIES

P.81

Heat Pump / Heat Recovery



RWEYQ-T

3-phase 4-wire system, 380-415 V/380 V, 50/60 Hz

Lineup

class	6	8	10	12	14	16	18	20	22	24	26	28	30	32	34	36
Heat Pump	●	●	●	●	●	●	●	●	●	●	●	●	●	●	●	●
Heat Recovery	●	●	●	●	●	●	●	●	●	●	●	●	●	●	●	●

Water cooled system suitable for tall multi-storey buildings

Water cooled **VRV IV W** series utilises water as a heat source. The temperature of heat source water can be from 10°C to 45°C, and outdoor air temperature does not affect cooling capacity. The outside unit is compact and saves space in the machine room.

VRV WS SERIES

P.105

Heat Pump



RWXYQ-A

1-phase, 220-240 V, 50 Hz

Lineup

class	3	4	5	6
Heat Pump	●	●	●	●

Water cooled system suitable for residential houses

Water cooled **VRV WS** series outside units are designed to be compact and lightweight, and single phase power supply enables simplified installation in residential applications.

Wide range indoor unit lineup creating

various comfortable airflow

VRV indoor units

● New lineup

Type	Model Name	Capacity Range(kW)	20	25	32	40	50	63	71	80	100	125	140	145	160	180	200	250
			2.2	2.8	3.6	4.5	5.6	7.1	8	9	11.2	14	16	16.2	18	20	22.4	28
			Capacity Index	20	25	31.25	40	50	62.5	71	80	100	125	140	145	160	180	200
Ceiling Mounted Cassette (Round Flow with Sensing)	FXFSQ-AVM		●	●	●	●	●		●	●	●	●						
Ceiling Mounted Cassette (Round Flow)	FXFQ-PVE		●	●	●	●	●		●	●	●							
Ceiling Mounted Cassette (Compact Multi Flow)	FXZQ-A2VEB		●	●	●	●	●											
4-Way Flow Ceiling Suspended	FXUQ-AVEB								●		●							
Ceiling Mounted Cassette (Double Flow)	New FXCQ-AVM		●	●	●	●	●	●		●		●						
Ceiling Mounted Cassette (Single Flow)	FXEQ-AV36		●	●	●	●	●	●										
Slim Ceiling Mounted Duct (Compact Series)	FXDQ-TV1B(A)		●	●	●	●	●											
Slim Ceiling Mounted Duct (Standard Series)	FXDQ-PDVE (700mm width type)		●	●	●													
	FXDQ-NDVE (900 / 1100mm width type)					●	●	●										
Ceiling Concealed Duct	FXDYQ-MAV1								●	●	●	●		●				
Middle Static Pressure Ceiling Mounted Duct	FXSQ-PAVE		●	●	●	●	●	●		●	●	●	●					
Ceiling Mounted Duct	FXMQ-PAVE		●	●	●	●	●	●		●	●	●	●					
	FXMQ-PV1A														●	●	●	●
Outdoor-Air Processing Unit	FXMQ-MFV1											●					●	●
Ceiling Suspended	FXHQ-MAVE				●			●			●							
	New FXHQ-AVM											●	●					
Wall Mounted	New FXAQ-AVM		●	●	●	●	●	●										
Floor Standing	FXLQ-MAVE		●	●	●	●	●	●										
Concealed Floor Standing	FXNQ-MAVE		●	●	●	●	●	●										
Heat Reclaim Ventilator with DX-Coil and Humidifier	VKM-GA(M)V1		Airflow rate 500-1000 m³/h															
Heat Reclaim Ventilator	VAM-GJVE		Airflow rate 150-2000 m³/h															
Air Handling Unit	AHUR		6-60 class															

Residential indoor units with connection to BP units

Type	Model Name	Rated Capacity (kW)	20	25	35	50	60	71
			2.0	2.5	3.5	5.0	6.0	7.1
			Capacity Index	20	25	35	50	60
Ceiling Mounted Cassette (Compact Multi Flow)	FFQ-BV1B			●	●	●	●	
Slim Ceiling Mounted Duct	FDXS-CVMA (900/1,100 mm width type)			●	●	●	●	
Wall Mounted	FTXS-KVMA		●	●	●			
	FTXS-KAVMA					●	●	●

Note: For indoor units connectability, please refer to the indoor unit product lineups under individual outdoor unit series.

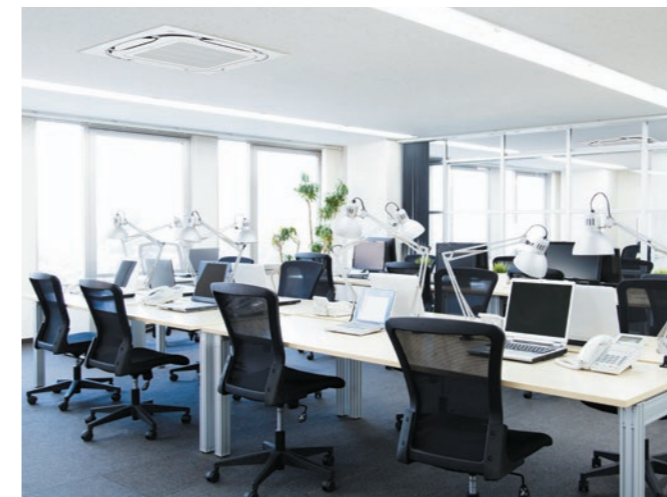

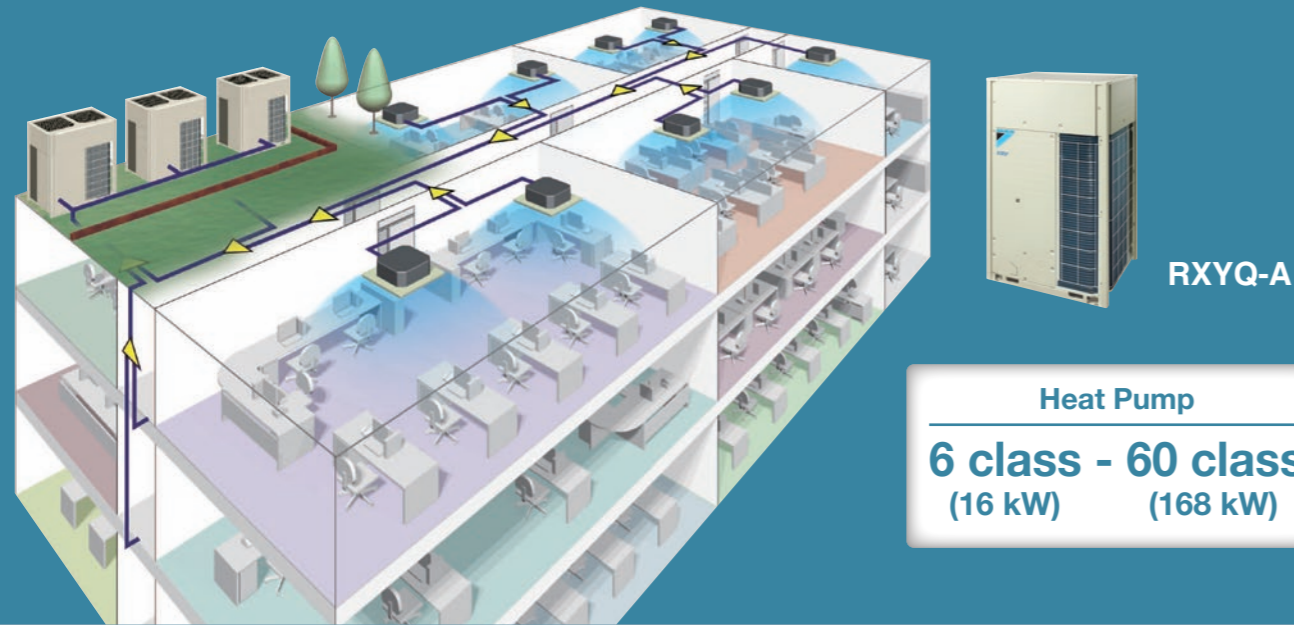

Heat Pump
6 class - 60 class
 (16 kW) (168 kW)

Greater energy savings during low-load operation

The key to innovative energy savings is to increase efficiency during low-load operation.

Using data gathered from actual operation, Daikin discovered that air conditioning systems operate at a load factor of 50% or less for 80% of their annual operation period.*

This inspired us to develop new technologies to enhance energy efficiency during low-load operation.

Utilising these technologies, Daikin's new VRV H series raises the standard of energy efficiency.

- * Main factors for frequent operation at low load of 50% or lower
- Because individual control is possible for VRV system, air conditioning is turned OFF to unoccupied rooms such as conference rooms, private rooms, and storage rooms.
- Maximum number of people assumed at the time of design has not been reached.
- There are zones without tenants such as the tenants' office building.

•Correlation between the load factor for the rated capacity and operation time (in office buildings in Singapore)
 *According to a survey by Daikin (based on Air Conditioning Network Service System data)

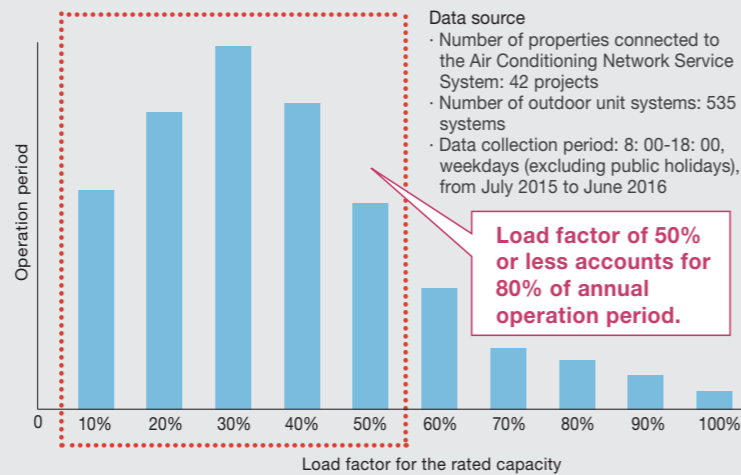

Higher Coefficient of Performance (COP)

COP for 10 class

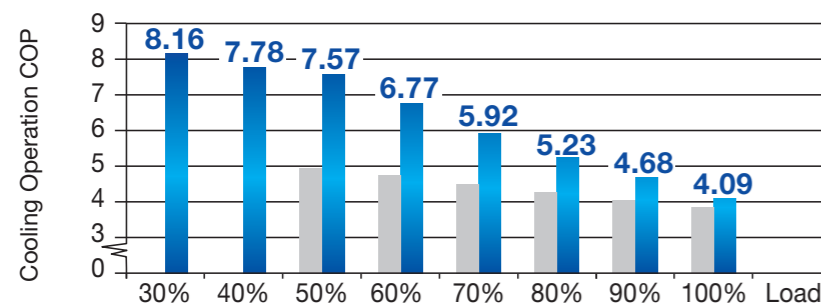

Annual power consumption 14%* lower

- * Simulation conditions :
- Location : Bangkok, Thailand
- System : Outdoor unit (10 class) x 1
- Indoor unit (2 class, Round Flow with Sensing type) x 5
- Operation time : 8:00-20:00 5 days/week
- Outdoor units :
- New model : RXYQ10A (VRV H series)
- Conventional model : RXYQ10T (VRV IV)

VRV IV (RXYQ10T)

VRV H SERIES

*Cooling operation conditions: Indoor temp. of 27°CDB, 19°CWB, and outdoor temp. of 35°CDB.

Advanced technologies for greater energy savings

By uniting advanced software and hardware technologies, VRV H Series is able to attain greater heights in energy savings and comfort.

VRT Smart Control (Fully Automatic Energy-saving Refrigerant Control)

Software technology

Daikin's VRT Smart technology takes comfort and energy performance to the next level. Building on our variable refrigerant temperature technology which enables the evaporating temperature to adjust to meet the varying load, VRT Smart is now also able to automatically adjust the indoor unit airflow rate (Airside Control) to ensure optimal comfort and energy performance is delivered at all times.



VRT Smart Control Function movie

•Overview of the control (system control flow)

Different automatic energy-saving refrigerant control applies depending on the indoor units connected.

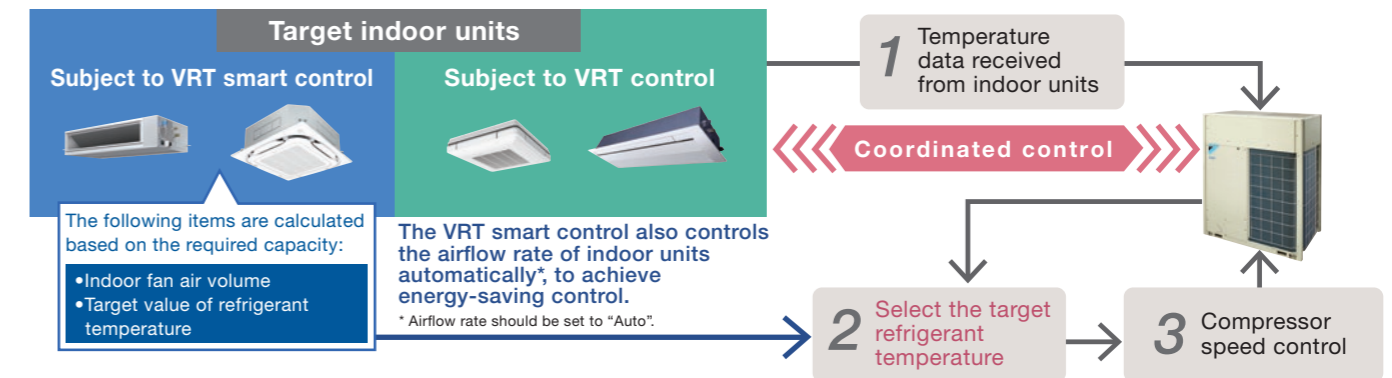

The smooth control (which keeps the compressor running) saves energy and ensures comfort during low-load operation.

•Changes in the room temperature during low-load operation*

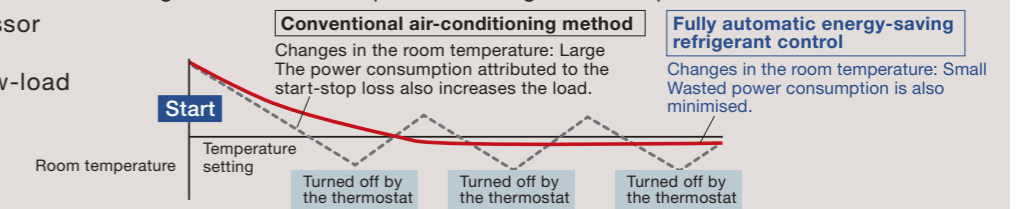

*Graph shown above is for illustration purposes only.

Note:

- For the classification of indoor units (VRT smart control and VRT control), refer to pages 25-26.
- If a system has indoor units subject to both VRT smart and VRT control, the system is operated under VRT control.
- If a system has both outdoor-air processing air conditioners and outdoor-air processing type indoor units, VRT smart control and VRT control are disabled.

Optimum utilisation of VRT Smart Control and VRT Control

VRT Smart and VRT control is most effective when all the indoor units operate under low load conditions in a similar manner. Low load conditions is the time when room temperature approaches set temperature.

For this reason, please note the following to maximise efficacy.

•When selecting indoor units

Indoor units are installed in a system so that they operate largely under the same conditions.

Energy efficiency decreases for the installation patterns indicated below.

Example:

- 1) A load imbalance occurs because an indoor unit on the same system is installed near the perimeter of the room or in the vicinity of a room entrance.
- 2) Different operating hours for indoor units.
- 3) Energy efficiency decreases when the set temperature of a specified indoor unit is set to an extreme during cooling operation. E.g. 18°C

New Scroll Compressor*

Hardware technology

Refrigerant leakage is minimised during low-load operation.

Operational loss due to refrigerant leakage is reduced with the inclusion of a proprietary back pressure control mechanism to ensure stable low-load operation.



New Scroll Compressor movie

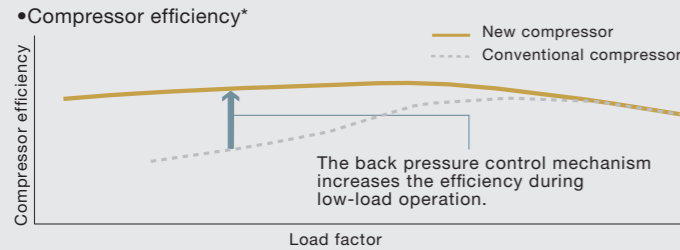

*Graph shown above is for illustration purposes only.

Back pressure control mechanism

Conventional mechanism

The orbiting scroll is engaged by the pressure difference between high and low pressures. The force engaging the orbiting scroll decreases during low-load operation, resulting in compression leakage from movable parts.

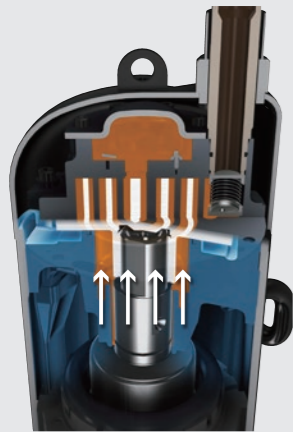

The force pressing the orbiting scroll decreases during low-load operation.

New intermediate pressure mechanism

The pressure on the orbiting scroll is optimised according to operating conditions. As a result, the orbiting scroll has been stabilised to increase efficiency during low-load operation.

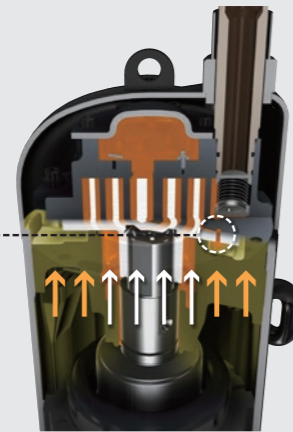

The intermediate pressure maintains pressure on the orbiting scroll during low-load operation.

Intermediate pressure adjustment port

The intermediate pressure (back pressure) optimises the pressure on the orbiting scroll depending on the operating condition.

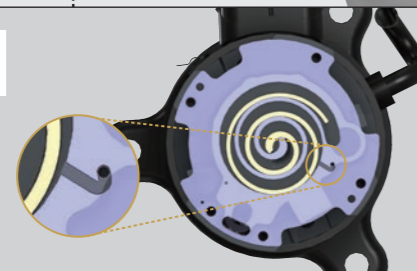

* The new mechanism is only applicable to RXYQ10, 12 and 20A models.

Advanced oil temperature control

Standby power consumption is reduced

The advanced oil temperature control reduces standby power consumption by up to 82.7%* annually compared to conventional models. Standby power needed for preheating refrigerator oil, which consumed substantial standby power, was reduced to save energy when the air conditioner is stopped.

* Operation calculation conditions: VRV H series 14 class
Location: Singapore
Operation time: 08:00-18:00 on weekdays.

High reliability

New inverter PC board

The control functions of inverter technology have been integrated on printed circuit boards. As well as improving reliability, this has reduced the number of parts and enabled downsizing.

- New waveform control improves tolerance of variations in power supply voltage. Even if the power supply has irregularities, rises in current are suppressed and operation continues.
- Durability of the inverter printed circuit board improved by changing the electrolytic capacitors for the compressor to film capacitors.

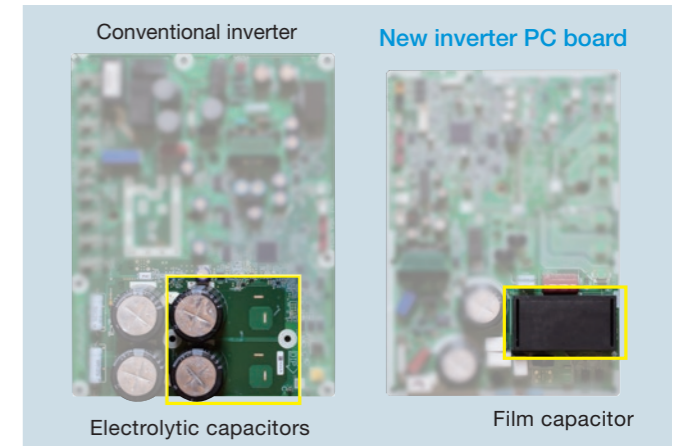

■ Comfort

Low operation sound

High efficiency heat exchanger helps to achieve low operation sound.

	Sound level(dB(A))			
	6/8 class	10 class	12 class	14/16 class
VRV H SERIES	56	57	59	60

Large airflow, high static pressure and quiet technology

Advanced analytic technologies are utilised to optimise fan design and increase airflow rate and high external static pressure.

Streamlined air grille

It promotes the discharge of swirling airflow, further reducing pressure loss.



Streamlined scroll fan

The curvature of each fan blade edge reduces both vibration and pressure loss.

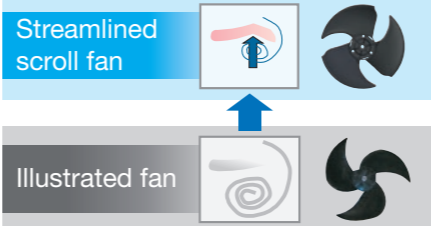



Nighttime quiet operation function

For areas with stringent restrictions placed on outdoor sound levels, the outdoor unit can be set for low operation sound during the nighttime to meet sound restrictions.

The automatic night quiet mode will initiate 8 hours*1 after the peak temperature is reached in the daytime, and normal operation will resume 9 hours*2 after that.

*1. Initial setting is 8 hours. Can be selected from 6, 8 and 10 hours.
*2. Initial setting is 9 hours. Can be selected from 8, 9 and 10 hours.
*3. In case of 10 class outdoor unit.

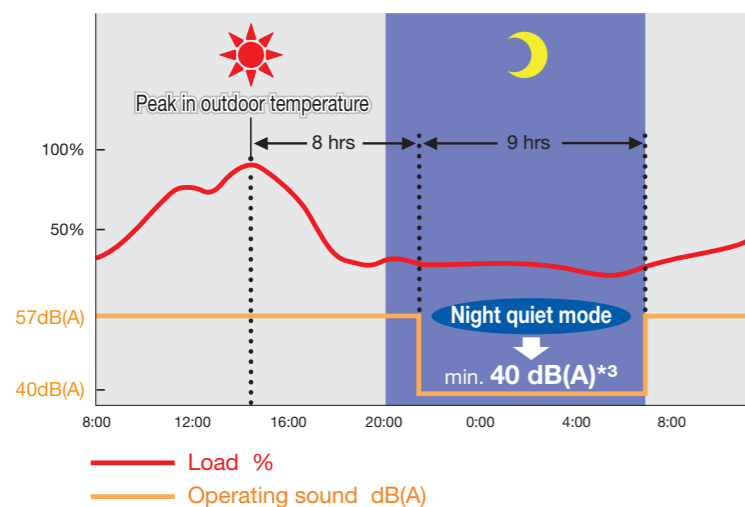

Note:
· The night quiet mode lowers operating sound by reducing capacity. This function is available in setting at site.
· The operating sound in quiet operation mode is the actual value measured by our company. Because priority is given to protection mode, such as for oil recovery, the operating sound may become higher temporarily.
· The relationship of outdoor temperature (load) and time shown above is just an example.

■ Compact design with high performance

Highly integrated heat exchanger

The unique 4-sided all round heat exchanger ensures sufficient surface area for the heat exchanger. This improves the heat exchanger performance without increasing the footprint.

Waffle Fin
A waffled-shaped fin with fin pitch of 1.4 mm was adopted to realise sufficient heat exchanger area for optimum unit efficiency.

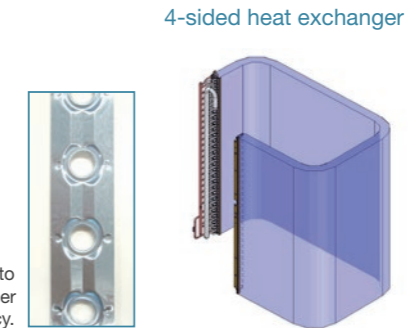

High efficiency heat exchanger is realised by reducing airflow resistance with adoption of small cooling tubes with a diameter of $\Phi 7$.

Optimised inner design to ensure smooth airflow

Electric components were downsized and positioned in the dead space of the bell mouth side to decrease airflow resistance.

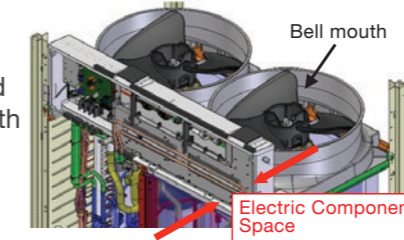

Sufficient cooling for electrical components

The VRV H series is designed with the electrical box strategically positioned between a region of positive and negative pressure. This design allows large airflow from negative pressure to positive pressure due to the high pressure difference.

• High pressure since air enters near the fan blower inlet

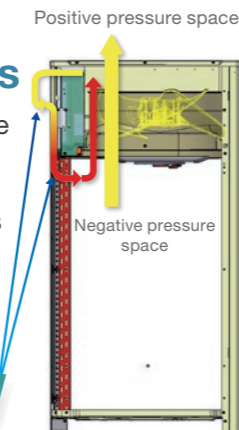

Easy maintenance

The electrical components are strategically located on the top which eases the maintenance process. Moreover, the heat exchanger on the front side can be used effectively to improve its performance.

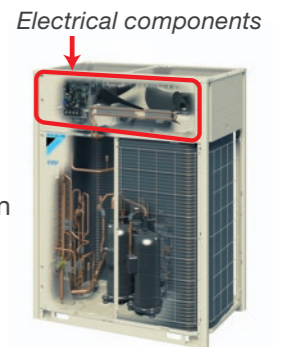

Eliminate suction resistance issue

Without affecting the fan volume, the electric components are designed to be at the top and this utilizes dead space. This eliminates the problem of suction resistance.

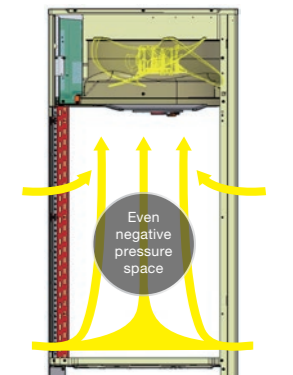

High reliability at high ambient temperatures

It is possible to keep operation stable even at high ambient temperatures by cooling the inverter power module. This helps maintain air-conditioning capacity and reduces failure ratio.

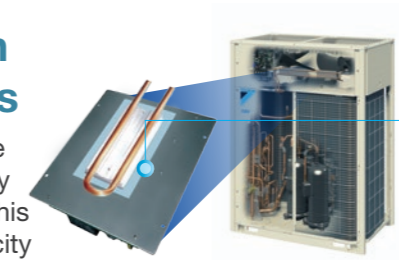

PC Board, Power Module, Refrigerant, Refrigerant Jacket, Heat

Using refrigerant to cool the inverter power module helps minimise the size of the electronic components, and this results in reduction of airflow resistance and high efficiency of the heat exchanger.

Control board failure ratio at stable operation is reduced.

Outer Rotor DC Motor (ODM)

Only Daikin has adapted an ODM with the feature of stable rotation and volumetric efficiency.

Advantages of ODM

- Thanks to the large diameter of the rotor,
- ① Large torque with same electromagnetic force
 - ② Stable rotation in all ranges and can be operated with small number of rotations

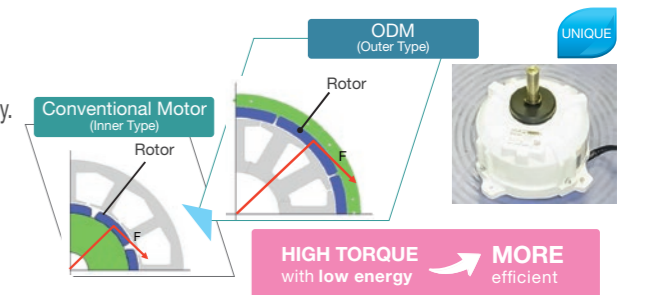

Conventional Motor (Inner Type), ODM (Outer Type), Rotor

HIGH TORQUE with low energy → MORE efficient

More options for installation location

Long piping length

The long piping length provides more design flexibility, which can match even large-sized buildings.

For connection of only VRV indoor units

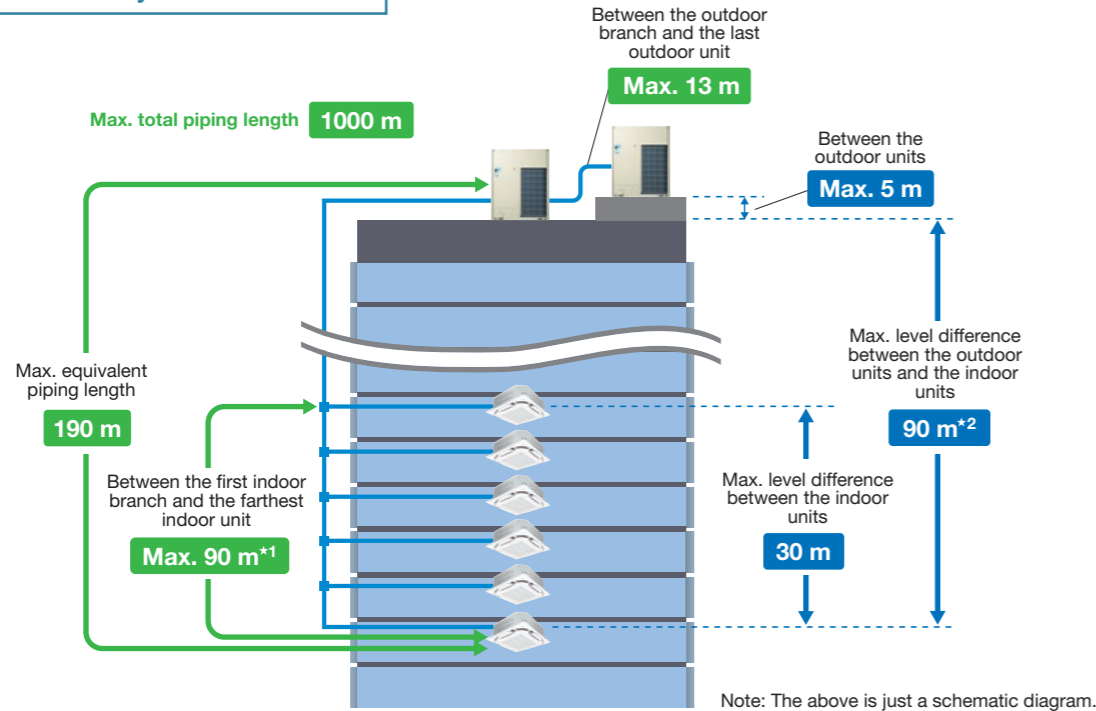

Maximum allowable piping length	Actual piping length (Equivalent)	165 m (190 m)
	Total piping length	1000 m
	Between the first indoor branch and the farthest indoor unit	90 m*1
Maximum allowable level difference	Between the outdoor units (Multiple use)	5 m
	Between the indoor units	30 m
	Between the outdoor units and the indoor units	90 m*2

*1. No special requirements up to 40 m. The maximum actual piping length can be 90 m, depending on conditions. The VRV H series is easy to extend to 90 m by lessening the conditions from conventional VRV IV models. Be sure to refer to the Engineering Data Book for details of these conditions and requirements.
*2. When level differences are 50 m or more, the diameter of the main liquid piping size must be increased. If the outdoor unit is above the indoor unit, a dedicated setting on the outdoor unit is required. Refer to the Engineering Data Book and contact your local dealer for more information.

Connection ratio

Connection capacity at maximum is 200%.

Connection ratio
50%–200%

$$\text{Connection ratio} = \frac{\text{Total capacity index of the indoor units}}{\text{Capacity index of the outdoor units}}$$

Conditions of VRV indoor unit connection capacity

Applicable VRV indoor units	FXDQ, FXSQ, FXMQ-PA, FXAQ models	Other VRV indoor unit models*1
Single outdoor units	200%	200%
Double outdoor units		160%
Triple outdoor units		130%

*1 For the FXF(S)Q25 models, maximum connection ratio is 130% for the entire range of outdoor units.
Note: If the operational capacity of indoor units is more than 130%, low airflow operation is enforced in all the indoor units.
*Refer to page 24 for outdoor unit combination details.

For mixed combination of VRV and residential indoor units

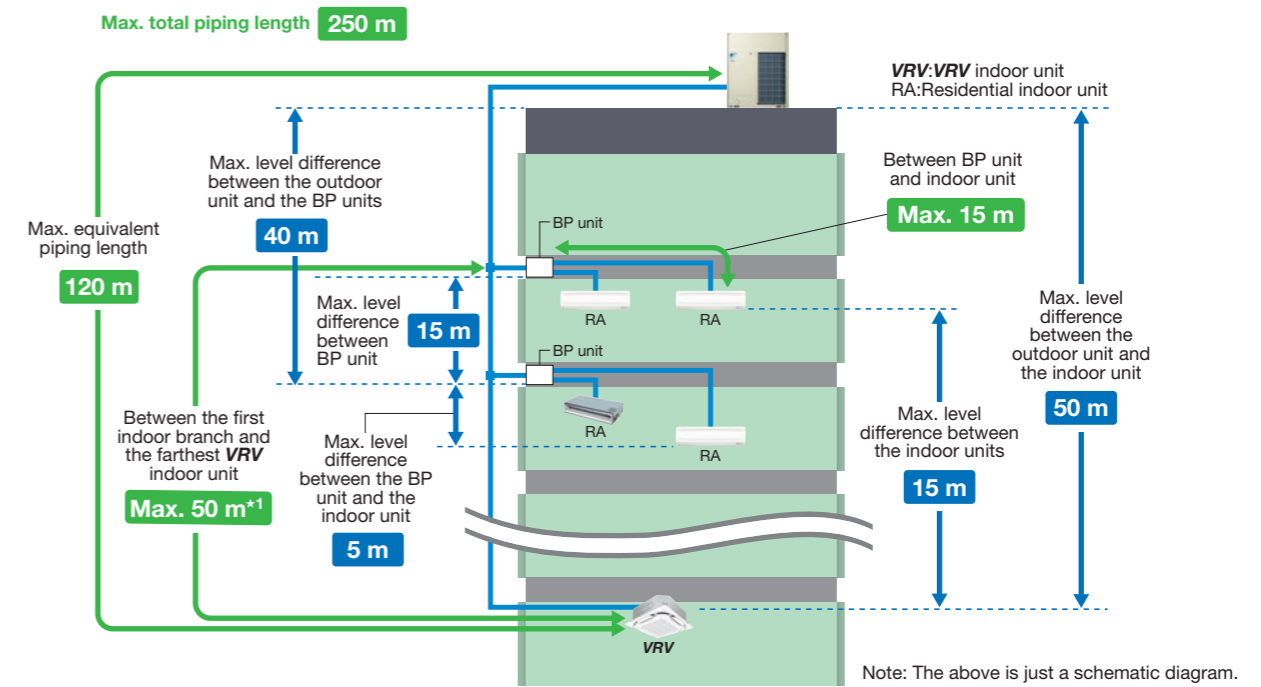

When a mixed combination of VRV and residential indoor units is connected or when only residential indoor units are connected

Maximum allowable piping length	Actual piping length (Equivalent)	100 m (120 m)
	Total piping length	250 m
	Between BP unit and indoor unit	If indoor unit capacity index < 60. 2 m–15 m If indoor unit capacity index is 60. 2 m–12 m If indoor unit capacity index is 71. 2 m–8 m
	Between the first indoor branch and the farthest BP unit or between the first indoor branch and the farthest VRV indoor unit	50 m*1
Maximum allowable level difference	Between outdoor unit and the first indoor branch	5 m
	Between the indoor units	15 m
	Between BP units	15 m
	Between the outdoor unit and the indoor unit	If the outdoor unit is above. 50 m If the outdoor unit is below. 40 m
	Between the outdoor unit and the BP unit	40 m
	Between the BP unit and the indoor unit	5 m

*1. If the piping length between the first indoor branch and BP unit or VRV indoor unit is over 20 m, it is necessary to increase the gas and liquid piping size between the first indoor branch and BP unit or VRV indoor unit. If the piping diameter of the sized up piping exceeds the diameter of the piping before the first indoor branch kit, then the latter also requires a liquid piping and gas piping size up. Please refer to Engineering Data Book for details.

*When a mixed combination of VRV and residential indoor units is connected or when only residential indoor units are connected, connection ratio must be 80% to 130%. Refer to page 24 for outdoor unit combination details.

High external static pressure

VRV H series outdoor unit has been achieved high external static pressure up to 78.4 Pa, ensuring the efficient heat dissipation and stable operation of equipment in either hierarchical or intensive arrangement.

78.4 Pa

- More options in the opening/angle of louvre
- Outstanding heat dissipation effect in both hierarchical and intensive arrangement

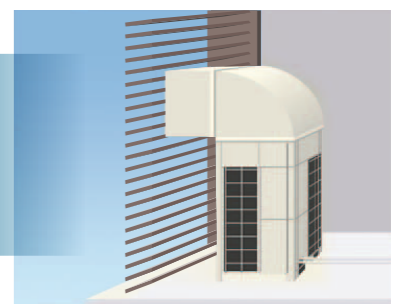

More accurate test operation and stable system

Efficient automatic test operation

Daikin **VRV H** series incorporates a simplified and efficient test operation function, that not only greatly accelerates the installation process, but also effectively improves the field setting quality.

- Automatically checks the wiring between outdoor units and indoor units to confirm whether there is defective wiring.
- Confirms piping length to optimise operation.
- Automatically checks whether the stop valve in each outdoor unit is functioning normally to ensure the smooth operation of air conditioning system.

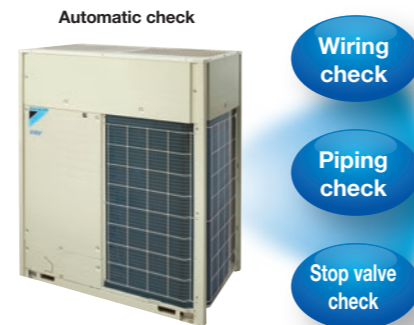

Simplified commissioning and after-sales service

Function of information display by luminous digital tube

VRV H series utilises 7-segment luminous digital tubes to display system operation information, enabling the operational state to be visually displayed whilst facilitating simplified commissioning and after-sales service.

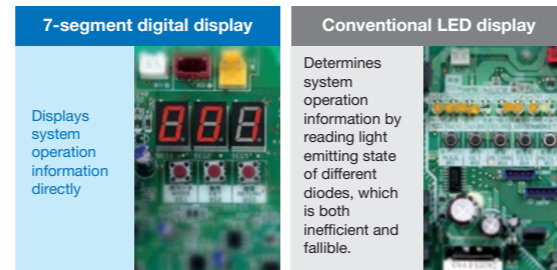

Advanced control main PC board

SMT* packaging technology

- SMT packaging technology adopted by the computer control panel improves the anti-clutter performance.
- Protects your computer boards from the adverse effects of sandy climates and humid weather.

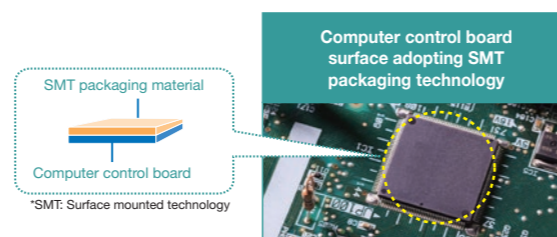

I-demand function

Limit to power consumption can be set precisely to one of 11 levels. Peak power cut-off can be accomplished according to each user situation.

*Set on the circuit board of the outdoor unit.

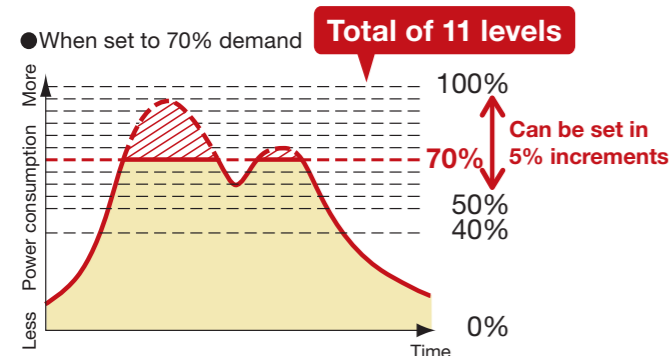

Wide operation temperature range

The versatile operation range of the **VRV H** series works to reduce limitations on installation locations. The operation temperature range for heating goes all the way down to -20°C , while cooling can be performed with outdoor temperatures as high as 49°C .

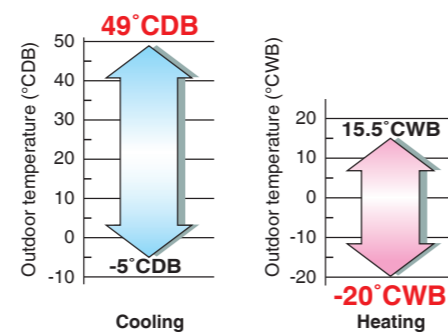

Automatic sequencing operation

During start-up, Daikin **VRV H** series outdoor unit sequencing operation will be automatically enabled to ensure balance operation of each outdoor unit to improve longevity of equipment and operation stability.

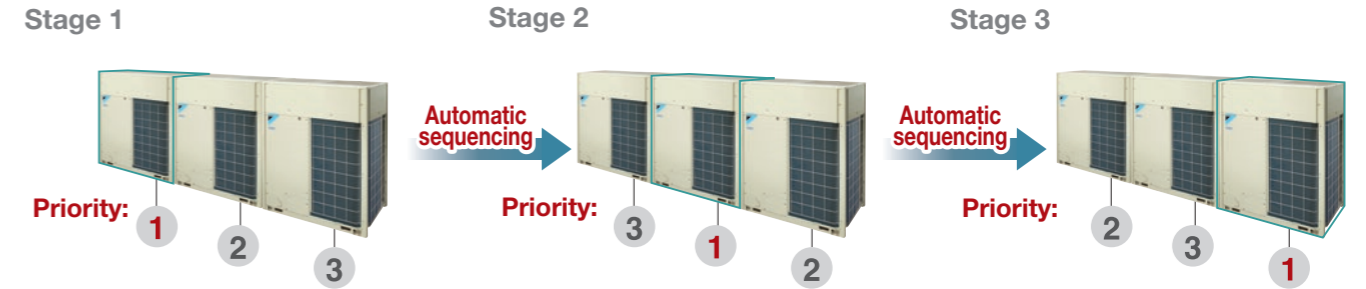

Double backup operation functions

Daikin **VRV H** series outdoor unit boasts double backup operation functions, which can secure the use of air conditioners in this area to the greatest extent in an emergency by enabling double backup operation functions even if failure occurs in a set of air conditioning equipment.

In the event of a failure, emergency operation can be conveniently enabled to allow the remaining system to operate in a limited fashion.

Unit backup operation function

If one of the units in a multiple outdoor system malfunctions, the other outdoor units provide emergency operation until repairs can be made.

* For systems composed of two or more outdoor units.



Compressor backup operation function

The outdoor unit is equipped with two compressors. Even if one compressor malfunctions, the other compressor provides emergency operation, reducing the risk of air conditioning shutdown due to compressor failure. (Capacity is saved during backup operation.)

* For single outdoor unit system RXYQ14-20AYM models. On-site settings are required using the printed circuit board of the outdoor unit.

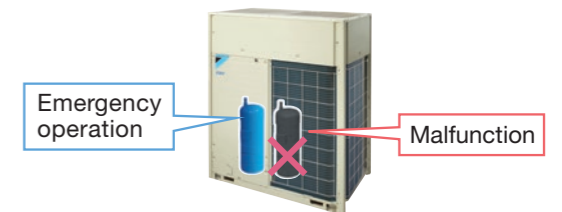

Ease of maintenance

VRV H series provides a maintenance feature* which allows the shutdown of indoor unit without shutting down the whole **VRV** system. This feature comes in handy during maintenance period as the remaining indoor units continue to operate.

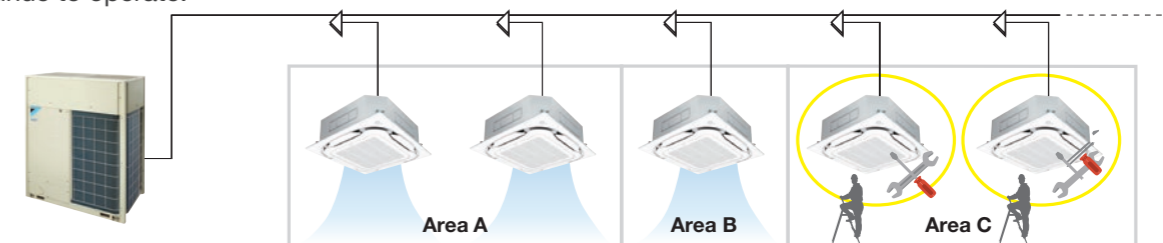

* Field setting is required. This feature does not apply to residential indoor unit connection. For more information, please contact Daikin sales office.

VRV H Series Outdoor Units Heat Pump

The outdoor unit capacity is up to 60 class (168 kW) in increment of 2 class.

- VRV H series outdoor unit offers a high capacity of up to 60 class, responding to the needs of large-sized building.
- The single outdoor unit has only 2 different shapes and dimensions, not only simplifying the design process, but also bringing the system flexibility to a new level.
- With the outdoor unit capacity increased in increment of 2 class, customers' needs can be precisely met.

Lineup

class		6	8	10	12	14	16	18	20	22	24	26	28	30	32	34	36	38	40	42	44	46	48	50	52	54	56	58	60	
VRV H SERIES	High-COP Type				●	●	●	●	●	●	●	●	●	●	●	●	●													
	Standard Type	●	●	●	●	●	●	●	●	●	●	●	●	●	●	●	●	●	●	●	●	●	●	●	●	●	●	●	●	●

High-COP Type

•Double Outdoor Units 12, 14, 16, 18, 20 class



RXYQ12AHYMA RXYQ18AHYMA
RXYQ14AHYMA RXYQ20AHYMA
RXYQ16AHYMA

•Triple Outdoor Units 22, 24, 26, 28, 30, 32, 34, 36 class



RXYQ22AHYMA RXYQ30AHYMA
RXYQ24AHYMA RXYQ32AHYMA
RXYQ26AHYMA RXYQ34AHYMA
RXYQ28AHYMA RXYQ36AHYMA

Standard Type

•Single Outdoor Units 6, 8, 10, 12 class 14, 16, 18, 20 class



RXYQ6AYM RXYQ14AYM
RXYQ8AYM RXYQ16AYM
RXYQ10AYM RXYQ18AYM
RXYQ12AYM RXYQ20AYM

•Double Outdoor Units 22, 24 class 26, 28, 30 class 32, 34, 36 class



RXYQ22AYMA RXYQ26AYMA RXYQ32AYMA
RXYQ24AYMA RXYQ28AYMA RXYQ34AYMA
RXYQ30AYMA RXYQ36AYMA

•Triple Outdoor Units 38, 40 class 42, 44 class 46, 48, 50, 52, 54, 56, 58, 60 class



RXYQ38AYMA RXYQ42AYMA RXYQ46AYMA RXYQ54AYMA
RXYQ40AYMA RXYQ44AYMA RXYQ48AYMA RXYQ56AYMA
RXYQ50AYMA RXYQ58AYMA
RXYQ52AYMA RXYQ60AYMA

Outdoor Unit Combinations

For connection of only VRV indoor units

High-COP Type

class	kW	Capacity index	Model name	Combination	Outdoor unit multi connection piping kit ^{*1}	Total capacity index of connectable indoor units ^{*2}	Maximum number of connectable indoor units ^{*2}
12	32.0	300	RXYQ12AH	RXYQ6A × 2	BHFP22P100	150 to 390 (480)	19 (24)
14	38.4	350	RXYQ14AH	RXYQ6A + RXYQ8A		175 to 455 (560)	22 (28)
16	44.8	400	RXYQ16AH	RXYQ8A × 2		200 to 520 (640)	26 (32)
18	50.4	450	RXYQ18AH	RXYQ8A + RXYQ10A		225 to 585 (720)	29 (36)
20	55.9	500	RXYQ20AH	RXYQ8A + RXYQ12A		250 to 650 (800)	32 (40)
22	60.8	550	RXYQ22AH	RXYQ6A + RXYQ8A × 2	BHFP22P151	275 to 715 (715)	35 (35)
24	67.2	600	RXYQ24AH	RXYQ8A × 3		300 to 780 (780)	39 (39)
26	72.8	650	RXYQ26AH	RXYQ8A × 2 + RXYQ10A		325 to 845 (845)	42 (42)
28	78.3	700	RXYQ28AH	RXYQ8A × 2 + RXYQ12A		350 to 910 (910)	45 (45)
30	83.9	750	RXYQ30AH	RXYQ8A + RXYQ10A + RXYQ12A		375 to 975 (975)	48 (48)
32	89.4	800	RXYQ32AH	RXYQ8A + RXYQ12A × 2		400 to 1,040 (1,040)	52 (52)
34	95.0	850	RXYQ34AH	RXYQ10A + RXYQ12A × 2		425 to 1,105 (1,105)	55 (55)
36	101	900	RXYQ36AH	RXYQ12A × 3		450 to 1,170 (1,170)	58 (58)

Standard Type

class	kW	Capacity index	Model name	Combination	Outdoor unit multi connection piping kit ^{*1}	Total capacity index of connectable indoor units ^{*2}	Maximum number of connectable indoor units ^{*2}
6	16.0	150	RXYQ6A	RXYQ6A	-	75 to 195 (300)	9 (15)
8	22.4	200	RXYQ8A	RXYQ8A	-	100 to 260 (400)	13 (20)
10	28.0	250	RXYQ10A	RXYQ10A	-	125 to 325 (500)	16 (25)
12	33.5	300	RXYQ12A	RXYQ12A	-	150 to 390 (600)	19 (30)
14	40.0	350	RXYQ14A	RXYQ14A	-	175 to 455 (700)	22 (35)
16	45.0	400	RXYQ16A	RXYQ16A	-	200 to 520 (800)	26 (40)
18	50.0	450	RXYQ18A	RXYQ18A	-	225 to 585 (900)	29 (45)
20	56.0	500	RXYQ20A	RXYQ20A	-	250 to 650 (1,000)	32 (50)
22	61.5	550	RXYQ22A	RXYQ10A + RXYQ12A	BHFP22P100	275 to 715 (880)	35 (44)
24	67.0	600	RXYQ24A	RXYQ12A × 2		300 to 780 (960)	39 (48)
26	73.5	650	RXYQ26A	RXYQ12A + RXYQ14A		325 to 845 (1,040)	42 (52)
28	78.5	700	RXYQ28A	RXYQ12A + RXYQ16A		350 to 910 (1,120)	45 (56)
30	83.5	750	RXYQ30A	RXYQ12A + RXYQ18A		375 to 975 (1,200)	48 (60)
32	90.0	800	RXYQ32A	RXYQ16A × 2		400 to 1,040 (1,280)	52 (64)
34	95.0	850	RXYQ34A	RXYQ16A + RXYQ18A		425 to 1,105 (1,360)	55 (64)
36	101	900	RXYQ36A	RXYQ16A + RXYQ20A		450 to 1,170 (1,440)	58 (64)
38	107	950	RXYQ38A	RXYQ12A × 2 + RXYQ14A		475 to 1,235 (1,235)	61 (61)
40	112	1,000	RXYQ40A	RXYQ12A × 2 + RXYQ16A		500 to 1,300 (1,300)	BHFP22P151
42	118	1,050	RXYQ42A	RXYQ10A + RXYQ16A × 2	525 to 1,365 (1,365)		
44	124	1,100	RXYQ44A	RXYQ12A + RXYQ16A × 2	550 to 1,430 (1,430)		
46	130	1,150	RXYQ46A	RXYQ14A + RXYQ16A × 2	575 to 1,495 (1,495)		
48	135	1,200	RXYQ48A	RXYQ16A × 3	600 to 1,560 (1,560)		
50	140	1,250	RXYQ50A	RXYQ16A × 2 + RXYQ18A	625 to 1,625 (1,625)		
52	145	1,300	RXYQ52A	RXYQ16A + RXYQ18A × 2	650 to 1,690 (1,690)		
54	150	1,350	RXYQ54A	RXYQ18A × 3	675 to 1,755 (1,755)		
56	156	1,400	RXYQ56A	RXYQ18A × 2 + RXYQ20A	700 to 1,820 (1,820)		
58	162	1,450	RXYQ58A	RXYQ18A + RXYQ20A × 2	725 to 1,885 (1,885)		
60	168	1,500	RXYQ60A	RXYQ20A × 3	750 to 1,950 (1,950)		

Note: *1. For multiple connection, the outdoor unit multi connection piping kit (separately sold) is required.

*2. Values inside brackets are based on connection of indoor units rated at maximum capacity, 200% for single outdoor units, 160% for double outdoor units, and 130% for triple outdoor units. Refer to page 19 for notes on connection capacity of indoor units.

For mixed combination of VRV and residential indoor units or connection of residential indoor units only

Model name ^{*1}	kW	class	Capacity index	Total capacity index of connectable indoor units ^{*2}			Maximum number of connectable indoor units
				Combination (%)			
				80%	100%	130%	
RXYQ6AYM	16.0	6	150	120	150	195	9
RXYQ8AYM	22.4	8	200	160	200	260	13
RXYQ10AYM	28.0	10	250	200	250	325	16
RXYQ12AYM	33.5	12	300	240	300	390	19
RXYQ14AYM	40.0	14	350	280	350	455	22
RXYQ16AYM	45.0	16	400	320	400	520	26
RXYQ18AYM	50.0	18	450	360	450	585	29
RXYQ20AYM	56.0	20	500	400	500	650	32

Note: *1. Only single outdoor unit (RXYQ6-20AYM) can be connected.

*2. Total capacity index of connectable indoor units must be 80%–130% of the capacity index of the outdoor unit.

VRV H Series Outdoor Units Heat Pump RXYQ-A

High-COP Type

Model		RXYQ12AHYMA	RXYQ14AHYMA	RXYQ16AHYMA	RXYQ18AHYMA	RXYQ20AHYMA	RXYQ22AHYMA
Combination units		RXYQ6AYM	RXYQ6AYM	RXYQ8AYM	RXYQ8AYM	RXYQ8AYM	RXYQ8AYM
Power supply		3-phase 4-wire system, 380-415 V/380 V, 50/60 Hz			3-phase 4-wire system, 380-415 V/380 V, 50/60 Hz		
Cooling capacity	Btu/h	109,000	131,000	153,000	172,000	191,000	207,000
	kW	32.0	38.4	44.8	50.4	55.9	60.8
Heating capacity	Btu/h	123,000	147,000	171,000	193,000	213,000	232,000
	kW	36.0	43.0	50.0	56.5	62.5	68.0
Power consumption	Cooling kW	6.76	8.55	10.3	12.0	13.9	13.7
	Heating kW	7.46	9.40	11.3	12.9	14.6	15.1
Capacity control	%	12-100	11-100	10-100	7-100		
Casing colour		Ivory white (5Y7.5/1)			Ivory white (5Y7.5/1)		
Compressor	Type	Hermetically sealed scroll type					
	Motor output kW	(2.4×1)+(2.4×1)	(2.4×1)+(3.4×1)	(3.4×1)+(3.4×1)	(3.4×1)+(4.5×1)	(3.4×1)+(5.5×1)	(2.4×1)+(3.4×1)+(3.4×1)
Airflow rate	l/s	1,983+1,983	1,983+2,967	2,967+2,967	2,967+2,967	2,967+3,183	1,983+2,967+2,967
	m³/min	119+119	119+178	178+178	178+178	178+191	119+178+178
Dimensions (H×W×D)	mm	(1,657×930×765)+(1,657×930×765)			(1,657×930×765)+(1,657×930×765)		(1,657×930×765)+(1,657×930×765)+(1,657×930×765)
Machine weight	kg	185+185			185+200		185+185+185
Sound level	dB(A)	59			60	61	
Sound power	dB(A)	80			81	82	
Operation range	Cooling °CDB	-5 to 49			-5 to 49		
	Heating °CWB	-20 to 15.5			-20 to 15.5		
Refrigerant	Type	R-410A					
	Charge kg	6.9+6.9	6.9+7.0	7.0+7.0	7.0+7.4	7.0+7.6	6.9+7.0+7.0
Piping connections	Liquid mm	φ12.7 (Brazing)			φ15.9 (Brazing)		φ15.9 (Brazing)
	Gas mm	φ28.6 (Brazing)			φ28.6 (Brazing)		

Model		RXYQ24AHYMA	RXYQ26AHYMA	RXYQ28AHYMA	RXYQ30AHYMA	RXYQ32AHYMA	RXYQ34AHYMA	RXYQ36AHYMA
Combination units		RXYQ8AYM	RXYQ8AYM	RXYQ8AYM	RXYQ8AYM	RXYQ8AYM	RXYQ10AYM	RXYQ12AYM
Power supply		3-phase 4-wire system, 380-415 V/380 V, 50/60 Hz			3-phase 4-wire system, 380-415 V/380 V, 50/60 Hz			
Cooling capacity	Btu/h	229,000	248,000	267,000	286,000	305,000	324,000	345,000
	kW	67.2	72.8	78.3	83.9	89.4	95.0	101
Heating capacity	Btu/h	256,000	278,000	299,000	321,000	341,000	365,000	386,000
	kW	75.0	81.5	87.5	94.0	100	107	113
Power consumption	Cooling kW	15.5	17.2	19.0	20.7	22.6	24.2	26.1
	Heating kW	17.0	18.6	20.3	21.8	23.5	25.1	26.7
Capacity control	%	7-100	5-100		5-100		4-100	
Casing colour		Ivory white (5Y7.5/1)			Ivory white (5Y7.5/1)			
Compressor	Type	Hermetically sealed scroll type						
	Motor output kW	(3.4×1)+(3.4×1)+(3.4×1)	(3.4×1)+(3.4×1)+(4.5×1)	(3.4×1)+(3.4×1)+(5.5×1)	(3.4×1)+(4.5×1)+(5.5×1)	(3.4×1)+(5.5×1)+(5.5×1)	(4.5×1)+(5.5×1)+(5.5×1)	(5.5×1)+(5.5×1)+(5.5×1)
Airflow rate	l/s	2,967+2,967+2,967			2,967+2,967+3,183		2,967+3,183+3,183	
	m³/min	178+178+178			178+178+191		178+191+191	
Dimensions (H×W×D)	mm	(1,657×930×765)+(1,657×930×765)+(1,657×930×765)						
Machine weight	kg	185+185+185	185+185+200		185+200+200		200+200+200	
Sound level	dB(A)	61		62	63		64	
Sound power	dB(A)	82		83	84		85	
Operation range	Cooling °CDB	-5 to 49						
	Heating °CWB	-20 to 15.5						
Refrigerant	Type	R-410A						
	Charge kg	7.0+7.0+7.0	7.0+7.0+7.4	7.0+7.0+7.6	7.0+7.4+7.6	7.0+7.6+7.6	7.4+7.6+7.6	7.6+7.6+7.6
Piping connections	Liquid mm	φ15.9 (Brazing)		φ19.1 (Brazing)		φ19.1 (Brazing)		
	Gas mm	φ34.9 (Brazing)		φ34.9 (Brazing)				

Note: Specifications are based on the following conditions;

- Cooling: Indoor temp.: 27°CDB, 19°CWB, Outdoor temp.: 35°CDB, Equivalent piping length: 7.5 m, Level difference: 0 m.
- Heating: Indoor temp.: 20°CDB, Outdoor temp.: 7°CDB, 6°CWB, Equivalent piping length: 7.5 m, Level difference: 0 m.

•Sound level: Anechoic chamber conversion value, measured at a point 1 m in front of the unit at a height of 1.5 m.

During actual operation, these values are normally somewhat higher as a result of ambient conditions and oil recovery mode.

When there is concern for noise the surrounding area such as residences, we recommend investigating the installation location and taking soundproofing measures.

VRV H Series Outdoor Units Heat Pump RXYQ-A

Standard Type

Model		RXYQ6AYM	RXYQ8AYM	RXYQ10AYM	RXYQ12AYM	RXYQ14AYM	RXYQ16AYM	RXYQ18AYM	RXYQ20AYM	RXYQ22AYMA	RXYQ24AYMA	RXYQ26AYMA	RXYQ28AYMA	RXYQ30AYMA	RXYQ32AYMA				
Combination units		—	—	—	—	—	—	—	—	RXYQ10AYM	RXYQ12AYM	RXYQ12AYM	RXYQ12AYM	RXYQ12AYM	RXYQ16AYM				
Power supply		3-phase 4-wire system, 380-415 V/380 V, 50/60 Hz						3-phase 4-wire system, 380-415 V/380 V, 50/60 Hz											
Cooling capacity		Btu/h	54,600	76,400	95,500	114,000	136,000	154,000	171,000	191,000	210,000	229,000	251,000	268,000	285,000	307,000			
		kW	16.0	22.4	28.0	33.5	40.0	45.0	50.0	56.0	61.5	67.0	73.5	78.5	83.5	90.0			
Heating capacity		Btu/h	61,400	85,300	107,000	128,000	154,000	171,000	191,000	215,000	235,000	256,000	281,000	299,000	319,000	341,000			
		kW	18.0	25.0	31.5	37.5	45.0	50.0	56.0	63.0	69.0	75.0	82.5	87.5	93.5	100			
Power consumption		Cooling kW	3.38	5.17	6.84	8.70	10.7	12.9	15.3	17.7	15.5	17.4	19.4	21.6	24.0	25.8			
		Heating kW	3.73	5.67	7.23	8.91	11.0	12.6	14.9	17.1	16.1	17.8	19.9	21.5	23.8	25.2			
Capacity control		%	25-100	20-100	13-100	12-100	11-100	10-100	10-100	7-100	6-100			5-100					
Casing colour		Ivory white (5Y7.5/1)						Ivory white (5Y7.5/1)											
Compressor		Type	Hermetically sealed scroll type						Hermetically sealed scroll type										
		Motor output kW	2.4x1	3.4x1	4.5x1	5.5x1	(2.9x1)+(3.3x1)	(3.6x1)+(3.7x1)	(4.1x1)+(4.0x1)	(3.7x1)+(6.3x1)	(4.5x1)+(5.5x1)	(5.5x1)+(5.5x1)	(5.5x1)+(2.9x1)+(3.3x1)	(5.5x1)+(3.6x1)+(3.7x1)	(5.5x1)+(4.1x1)+(4.0x1)	(3.6x1)+(3.7x1)+(3.6x1)+(3.7x1)			
Airflow rate		l/s	1,983	2,967		3,183		4,283		4,200	4,950	2,967+3,183		3,183+3,183		3,183+4,283		3,183+4,200	4,283+4,283
		m³/min	119	178		191		257		252	297	178+191		191+191		191+257		191+252	257+257
Dimensions (HxWxD)		mm	1,657x930x765			1,657x1,240x765			1,657x1,240x765			(1,657x930x765)+(1,657x930x765)			(1,657x930x765)+(1,657x1,240x765)			(1,657x1,240x765)+(1,657x1,240x765)	
Machine weight		kg	185		200		285		305	325	200+200		200+285		200+305	285+285			
Sound level		dB(A)	56		57	59	60	61	65	61	62	63		64					
Sound power		dB(A)	77		78	80	81	82	86	82	83	84		84					
Operation range		Cooling °CDB	-5 to 49						-5 to 49										
		Heating °CWB	-20 to 15.5						-20 to 15.5										
Refrigerant		Type	R-410A						R-410A										
		Charge kg	6.9	7.0	7.4	7.6	9.1	9.3	11.8		7.4+7.6	7.6+7.6	7.6+9.1	7.6+9.3	7.6+11.8	9.3+9.3			
Piping connections		Liquid mm	φ9.5 (Brazeing)			φ12.7 (Brazeing)			φ15.9 (Brazeing)			φ19.1 (Brazeing)			φ19.1 (Brazeing)				
		Gas mm	φ19.1 (Brazeing)			φ22.2 (Brazeing)			φ28.6 (Brazeing)			φ28.6 (Brazeing)			φ34.9 (Brazeing)				

Model		RXYQ34AYMA	RXYQ36AYMA	RXYQ38AYMA	RXYQ40AYMA	RXYQ42AYMA	RXYQ44AYMA	RXYQ46AYMA	RXYQ48AYMA	RXYQ50AYMA	RXYQ52AYMA	RXYQ54AYMA	RXYQ56AYMA	RXYQ58AYMA	RXYQ60AYMA					
Combination units		RXYQ16AYM	RXYQ16AYM	RXYQ12AYM	RXYQ12AYM	RXYQ10AYM	RXYQ12AYM	RXYQ14AYM	RXYQ16AYM	RXYQ16AYM	RXYQ16AYM	RXYQ18AYM	RXYQ18AYM	RXYQ18AYM	RXYQ20AYM					
Power supply		3-phase 4-wire system, 380-415 V/380 V, 50/60 Hz						3-phase 4-wire system, 380-415 V/380 V, 50/60 Hz												
Cooling capacity		Btu/h	324,000	345,000	365,000	382,000	403,000	423,000	444,000	461,000	478,000	495,000	512,000	532,000	553,000	573,000				
		kW	95.0	101	107	112	118	124	130	135	140	145	150	156	162	168				
Heating capacity		Btu/h	362,000	386,000	409,000	427,000	450,000	471,000	495,000	512,000	532,000	553,000	573,000	597,000	621,000	645,000				
		kW	106	113	120	125	132	138	145	150	156	162	168	175	182	189				
Power consumption		Cooling kW	28.2	30.6	28.1	30.3	32.6	34.5	36.5	38.7	41.1	43.5	45.9	48.3	50.7	53.1				
		Heating kW	27.5	29.7	28.8	30.4	32.4	34.1	36.2	37.8	40.1	42.4	44.7	46.9	49.1	51.3				
Capacity control		%	5-100	4-100			3-100			3-100			2-100							
Casing colour		Ivory white (5Y7.5/1)						Ivory white (5Y7.5/1)												
Compressor		Type	Hermetically sealed scroll type						Hermetically sealed scroll type											
		Motor output kW	(3.6x1)+(3.7x1)+(4.1x1)+(4.0x1)	(3.6x1)+(3.7x1)+(3.7x1)+(6.3x1)	(5.5x1)+(5.5x1)+(2.9x1)+(3.3x1)	(5.5x1)+(5.5x1)+(3.6x1)+(3.7x1)	(4.5x1)+(3.6x1)+(3.7x1)+(3.6x1)+(3.7x1)	(5.5x1)+(3.6x1)+(3.7x1)+(3.6x1)+(3.7x1)	(2.9x1)+(3.3x1)+(3.6x1)+(3.6x1)+(3.7x1)+(3.6x1)	(3.6x1)+(3.7x1)+(3.6x1)+(3.6x1)+(3.7x1)+(3.6x1)	(3.6x1)+(3.7x1)+(3.6x1)+(3.6x1)+(3.7x1)+(3.6x1)	(3.6x1)+(3.7x1)+(4.1x1)+(4.0x1)+(4.0x1)+(4.1x1)+(4.0x1)	(4.1x1)+(4.0x1)+(4.1x1)+(4.1x1)+(4.0x1)+(3.7x1)+(6.3x1)	(4.1x1)+(4.0x1)+(4.1x1)+(4.1x1)+(4.0x1)+(3.7x1)+(6.3x1)	(4.1x1)+(4.0x1)+(3.7x1)+(6.3x1)+(6.3x1)+(3.7x1)+(6.3x1)	(3.7x1)+(6.3x1)+(3.7x1)+(6.3x1)				
Airflow rate		l/s	4,283+4,200	4,283+4,950	3,183+3,183+4,283		2,967+4,283+4,283		3,183+4,283+4,283		4,283+4,283+4,283		4,283+4,200+4,200		4,200+4,200+4,200		4,200+4,950+4,950		4,950+4,950+4,950	
		m³/min	257+252	257+297	191+191+257		178+257+257		191+257+257		257+257+257		257+257+252		257+252+252		252+252+297		252+297+297	
Dimensions (HxWxD)		mm	(1,657x1,240x765)+(1,657x1,240x765)		(1,657x930x765)+(1,657x930x765)+(1,657x1,240x765)		(1,657x930x765)+(1,657x1,240x765)+(1,657x1,240x765)		(1,657x1,240x765)+(1,657x1,240x765)+(1,657x1,240x765)		(1,657x1,240x765)+(1,657x1,240x765)+(1,657x1,240x765)									
Machine weight		kg	285+305	285+325	200+200+285		200+285+285		285+285+285		285+285+305	285+305+305	305+305+305	305+305+325	305+325+325	325+325+325				
Sound level		dB(A)	64	66	64		64		65		66		68	69	70					
Sound power		dB(A)	85	87	85		85		86		87		89	90	91					
Operation range		Cooling °CDB	-5 to 49						-5 to 49											
		Heating °CWB	-20 to 15.5						-20 to 15.5											
Refrigerant		Type	R-410A						R-410A											
		Charge kg	9.3+11.8		7.6+7.6+9.1	7.6+7.6+9.3	7.4+9.3+9.3	7.6+9.3+9.3	9.1+9.3+9.3	9.3+9.3+9.3	9.3+9.3+11.8	9.3+11.8+11.8	11.8+11.8+11.8							
Piping connections		Liquid mm	φ19.1 (Brazeing)						φ19.1 (Brazeing)											
		Gas mm	φ34.9 (Brazeing)			φ41.3 (Brazeing)			φ41.3 (Brazeing)											

Note: Specifications are based on the following conditions;

- Cooling: Indoor temp.: 27°CDB, 19°CWB, Outdoor temp.: 35°CDB, Equivalent piping length: 7.5 m, Level difference: 0 m.
- Heating: Indoor temp.: 20°CDB, Outdoor temp.: 7°CDB, 6°CWB, Equivalent piping length: 7.5 m, Level difference: 0 m.

•Sound level: Anechoic chamber conversion value, measured at a point 1 m in front of the unit at a height of 1.5 m.

During actual operation, these values are normally somewhat higher as a result of ambient conditions and oil recovery mode.

When there is concern for noise the surrounding area such as residences, we recommend investigating the installation location and taking soundproofing measures.

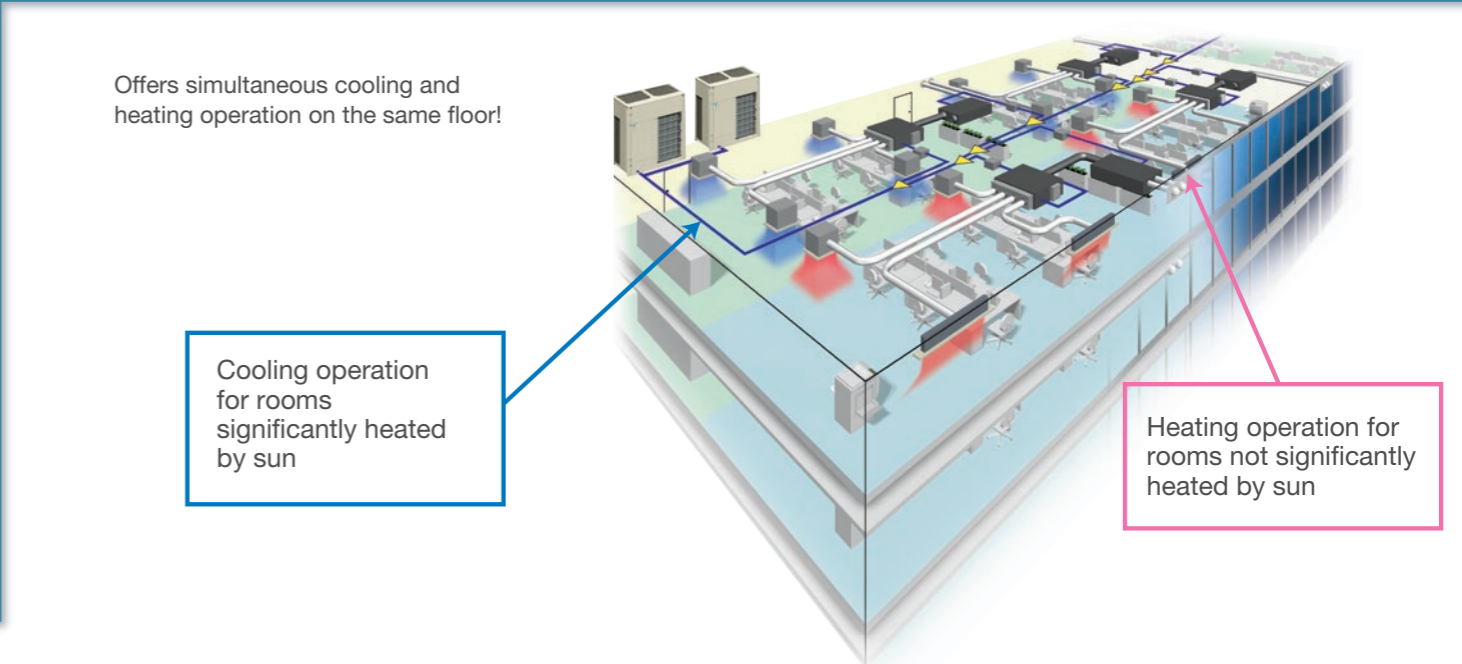
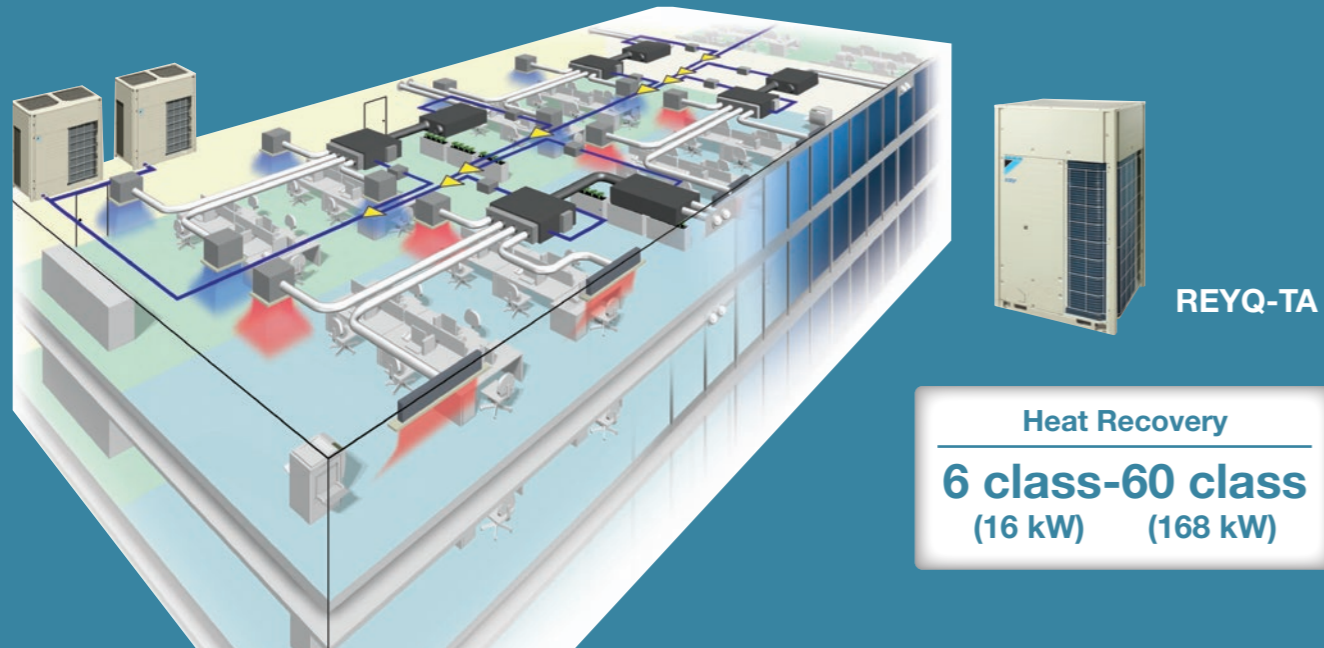

VAV R SERIES Heat Recovery

What is Heat Recovery Air Conditioner?

Modern office buildings are highly airtight and subject to an increasing heat load due to the use of computers, lighting equipment and other office equipment. In these buildings some rooms may require artificial cooling even in winter, depending on the amount of sunshine received and the number of people in the room. In order to meet such requirements the Heat Recovery Series enables the simultaneous operation of cooling and heating by controlling the BS unit that switches cooling and heating. This series also substantially improves energy efficiency by recycling waste heat.

Operation mode

Heat recovery operation mode

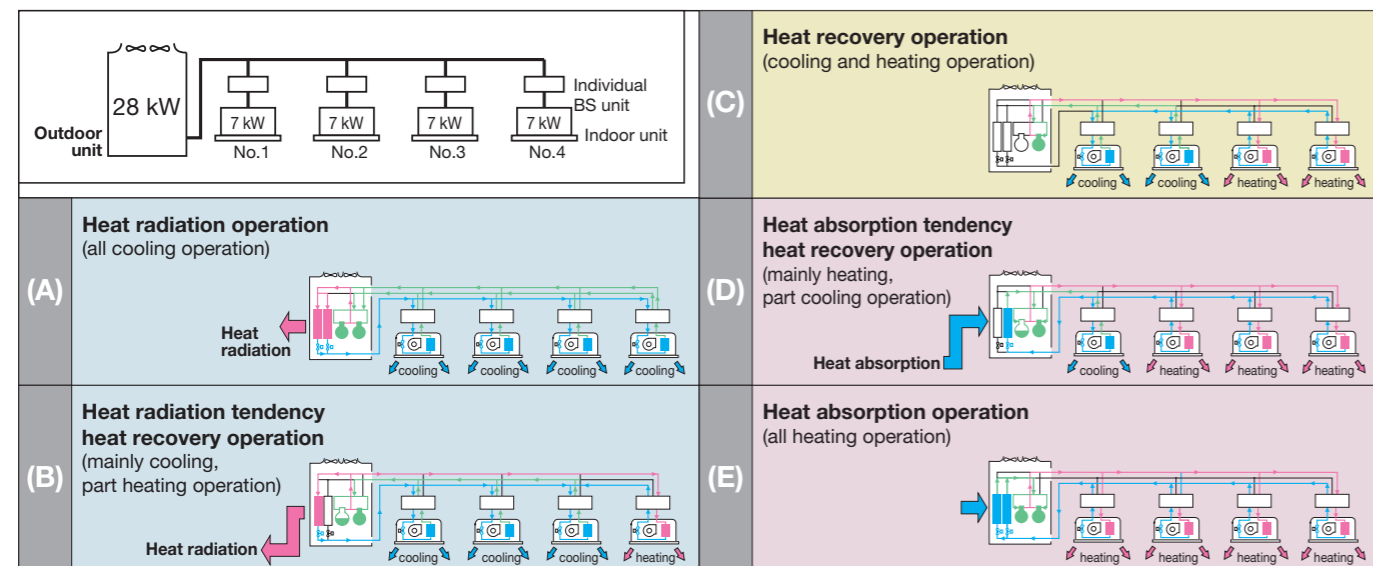

Note: Operation modes (A) and (E) are applicable when the outdoor temperature is 35°C and 7°C respectively; The other modes are applicable under typical outdoor conditions.

Increasing demand for simultaneous cooling and heating needs

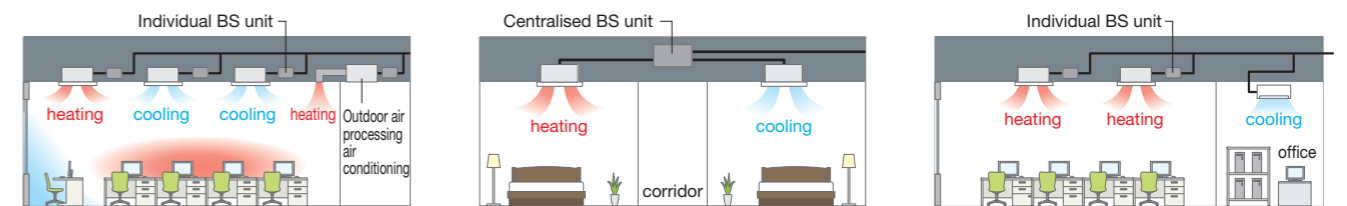

Winter season (Office Building)

- Difference between the load of cold air and heat from room is large
- Can be use with the outdoor air processing air conditioning

Winter season (Hotel)

- Able to cater to individual heating and cooling requirement

Individual office

- Provides heating and annual cooling depending on space area

BS unit (Individual type/Centralised type)

By adding suction gas piping and a BS unit (sold separately), simultaneous cooling and heating operation can be provided by a single system.

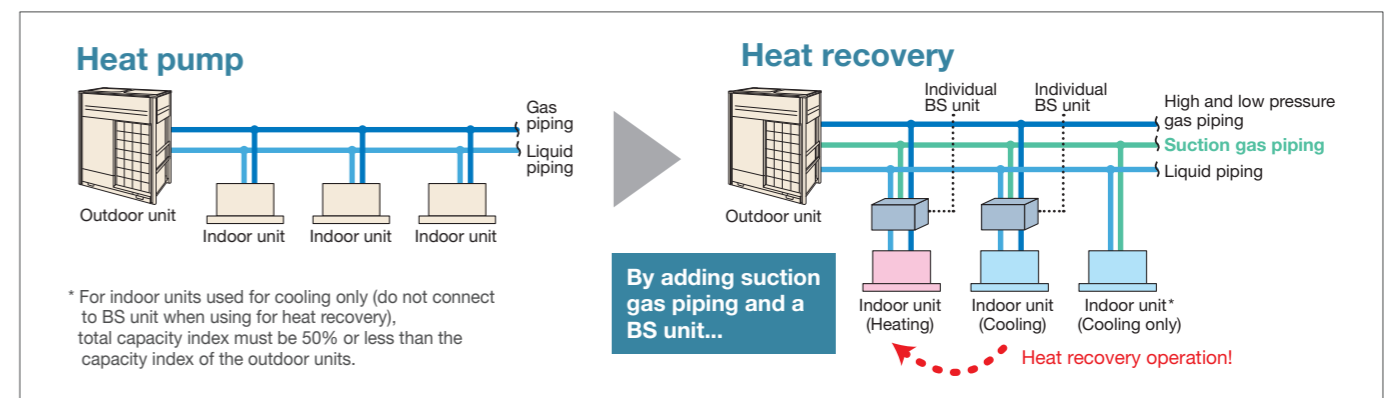
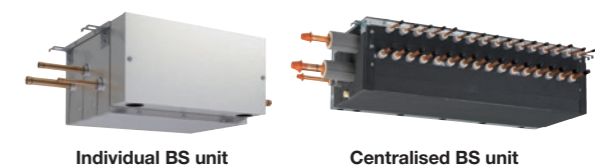

Advanced technologies for greater energy savings

By utilising advanced software technologies, VRV R Series is able to attain greater heights in energy savings and comfort.

VRT Smart Control (Fully Automatic Energy-saving Refrigerant Control)

Software technology

Daikin's VRT Smart technology takes comfort and energy performance to the next level. Building on our variable refrigerant temperature technology which enables the evaporating temperature to adjust to meet the varying load, VRT Smart is now also able to automatically adjust the indoor unit airflow rate (Airside Control) to ensure optimal comfort and energy performance is delivered at all times.



VRT Smart Control Function movie

Overview of the control (system control flow)

Different automatic energy-saving refrigerant control applies depending on the indoor units connected.

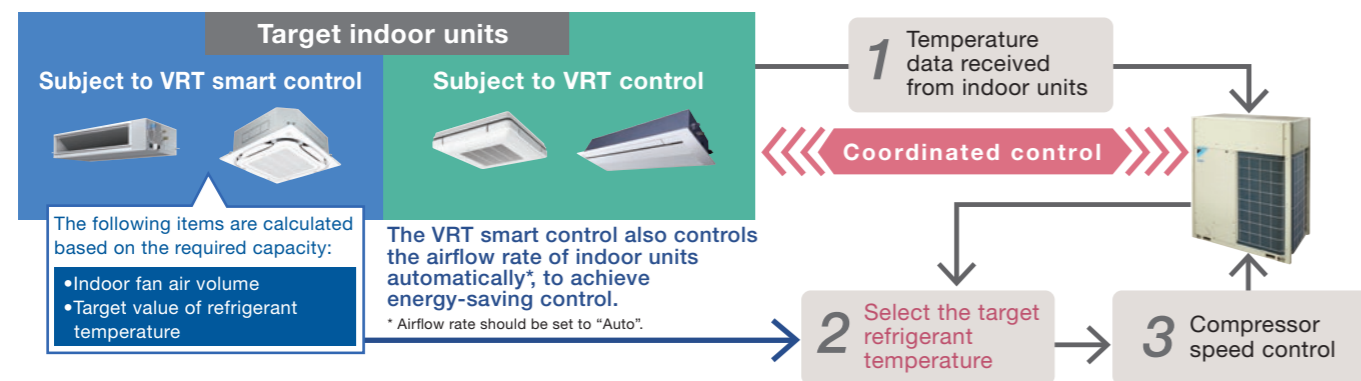

The smooth control (which keeps the compressor running) saves energy and ensures comfort during low-load operation.

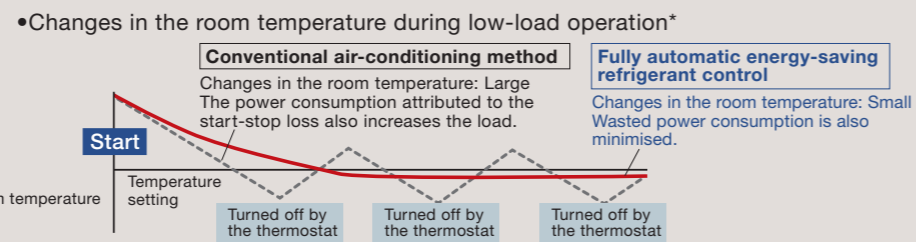

Note:
 • For the classification of indoor units (VRT smart control and VRT control), refer to pages 47-48.
 • If a system has indoor units subject to both VRT smart and VRT control, the system is operated under VRT control.
 • If a system has both outdoor-air processing air conditioners and outdoor-air processing type indoor units, VRT smart control and VRT control are disabled only available during either all cooling operation or all heating operation.

Optimum utilisation of VRT Smart Control and VRT Control

VRT Smart and VRT control is most effective when all the indoor units operate under low load conditions in a similar manner. Low load conditions is the time when room temperature approaches set temperature. For this reason, please note the following to maximise efficacy.

When selecting indoor units

Indoor units are installed in a system so that they operate largely under the same conditions.

Energy efficiency decreases for the installation patterns indicated below.

Example:

- 1) A load imbalance occurs because an indoor unit on the same system is installed near the perimeter of the room or in the vicinity of a room entrance.
- 2) Different operating hours for indoor units.
- 3) Energy efficiency decreases when the set temperature of a specified indoor unit is set to an extreme during cooling operation. E.g. 18°C

Enhanced lineup

Wider capacity range from 6 to 60 class

With its enhanced lineup of 2 types-High-COP and Standard types, VRV R series Heat Recovery outdoor units offer a wider capacity range from 6 class (16 kW) to 60 class (168 kW) to meet an ever wider variety of needs.

Single Outdoor Unit

VRV III



8, 10, 12, 14, 16 class

From 8 to 16 class

VRV R SERIES



6, 8, 10, 12 class 14, 16, 18, 20 class

From 6 to 20 class

Multiple Outdoor Units

VRV III



From 18 to 48 class

1 type only

VRV R SERIES



From 12 to 60 class

2 types of High-COP type and Standard type

Lineup

class	6	8	10	12	14	16	18	20	22	24	26	28	30	32	34	36	38	40	42	44	46	48	50	52	54	56	58	60
High-COP Type				●	●	●	●	●	●	●	●	●	●	●	●	●												
Standard Type	●	●	●	●	●	●	●	●	●	●	●	●	●	●	●	●	●	●	●	●	●	●	●	●	●	●	●	●

Ease of installation

Compact & lightweight design

Highly-integrated VRV R series offers compact outdoor units to achieve maximum utilisation of the installation space.

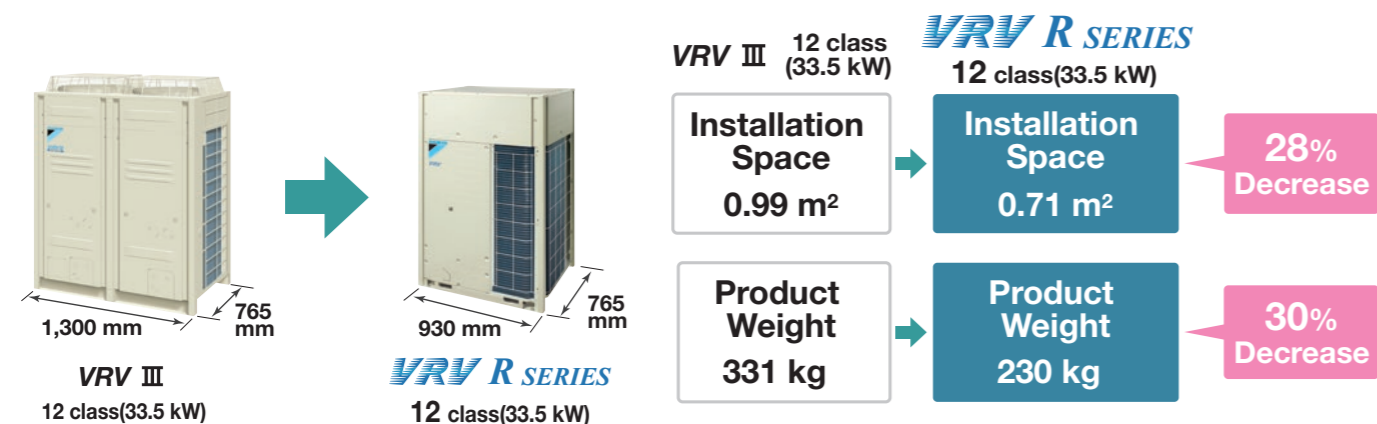

Comfort

Lower operation sound

Improve heat exchanger efficiency, helps to reduced operation sound.

	Sound level(dB(A))				
	6/8 class	10 class	12 class	14 class	16 class
VRV III	58	58	60	62	63
VRV R SERIES	56	57	59	60	61

1-2 dB(A) reduction than conventional model

Large airflow, high static pressure and quiet technology

Without increasing operation sound, advanced analytical technologies are utilised to optimise fan design and increase airflow rate and high external static pressure.

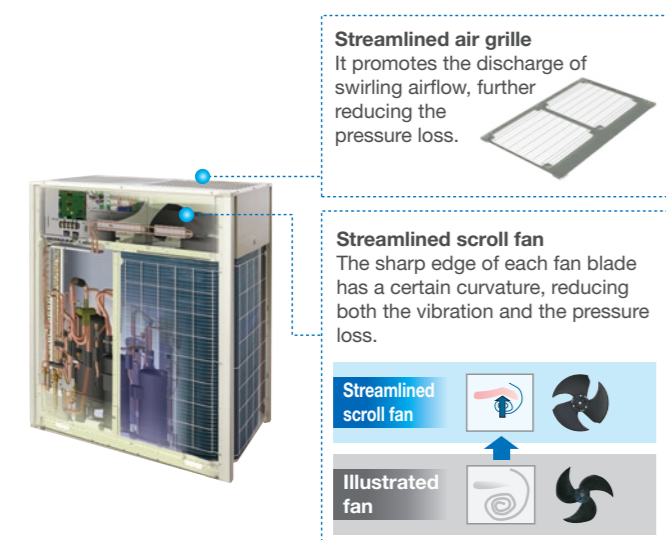

Nighttime quiet operation function

Outdoor PCB automatically memorises the time when the peak outdoor temperature appears. It will enable quiet operation mode after 8 h¹, and return to normal mode after it keeps for 9 h².

*1. 8 h is the initial setting with 6 h or 10 h also available.
*2. 9 h is the initial setting with 8 h or 10 h also available.
*3. In case of 10 class outdoor unit during cooling operation.

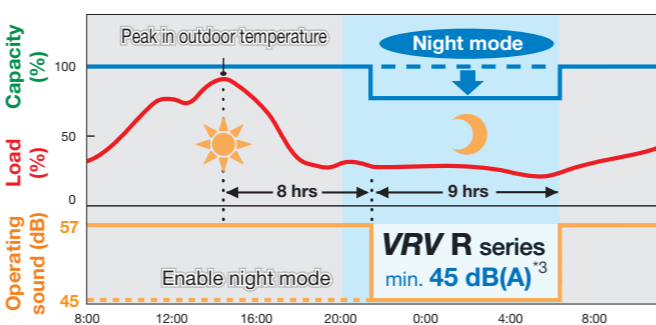

Note: · This function is available in setting at site.
· The operating sound in quiet operation mode is the actual value measured by our company.
· The relationship of outdoor temperature (load) and time shown above is just an example.

Energy saving

Higher Coefficient of Performance (COP)

It has become essential for air conditioning manufacturers to develop systems that provide high energy savings. We at Daikin have made great efforts in this field, and the VRV R series delivers highly efficient performance, contributing to high energy savings.

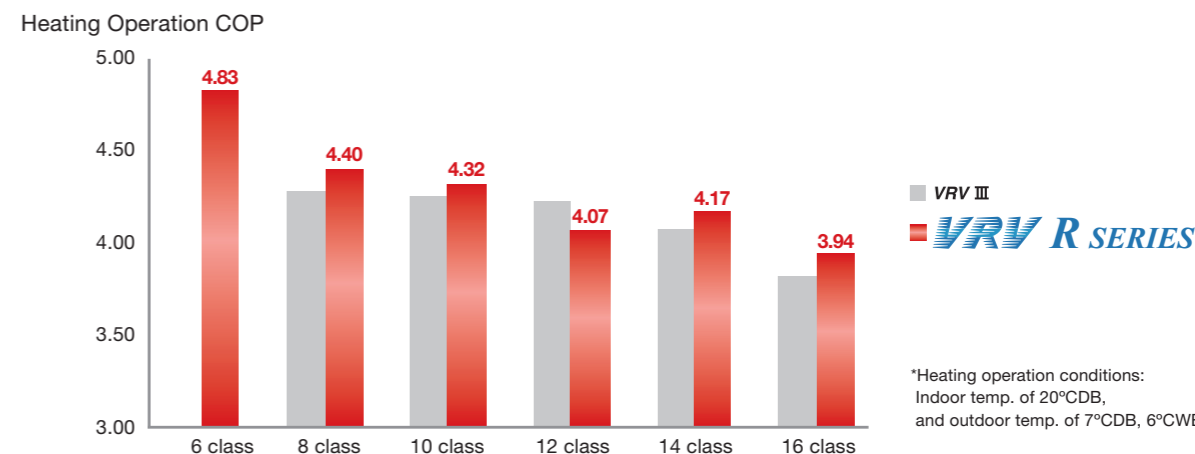
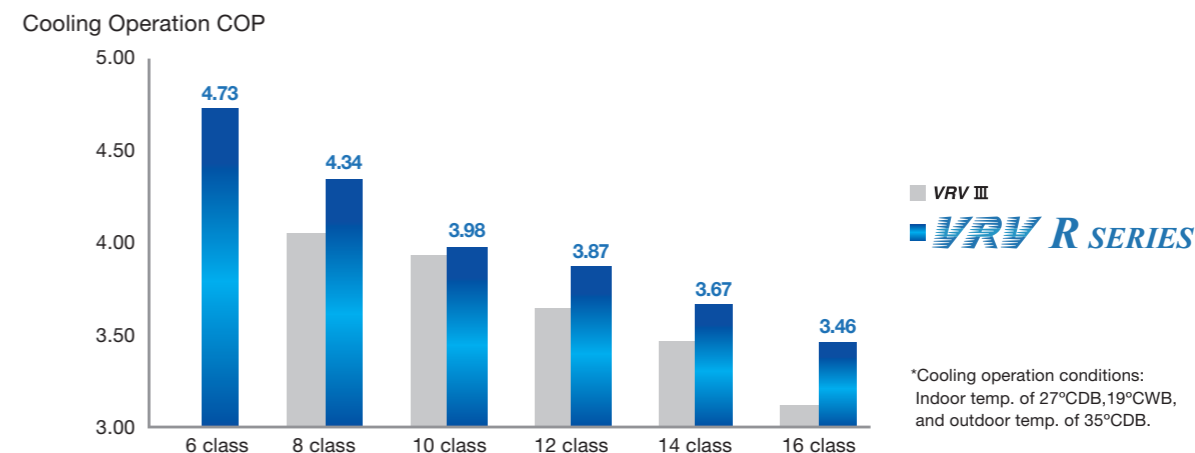

The heat recovery system utilises waste heat, achieving outstanding energy conservation performance.

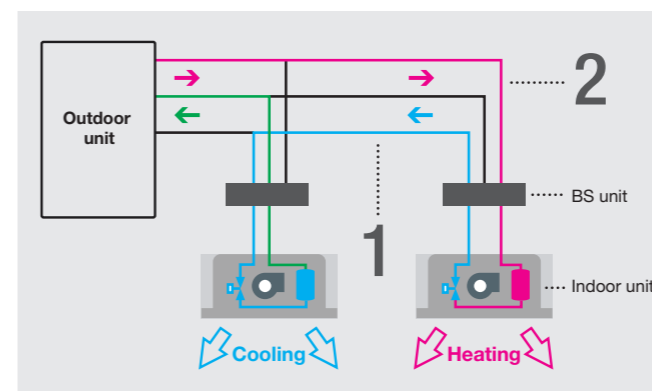

1 The (cold) waste heat from heating is used for the cooling operation.

2 The waste heat from cooling is used to generate heat that is needed for heating operation while conserving electricity.

The flexibility of simultaneous cooling and heating operation has been further enhanced by various advanced technologies.

Development of a highly efficient heat exchanger utilising of a two-split structure

In a conventional system, two heat exchanger panels are utilised: one is used as an evaporator; while the other is used as a condenser. In the newly developed system, a two-split structure is utilised, with one panel split into two parts (top and bottom) at an optimal ratio depending on the capacity required for simultaneous cooling and heating operation. Heat radiation loss has been minimised, and the heat recovery efficiency and partial load characteristics have been improved.

Comparison of 12 class system (During simultaneous cooling and heating operation)

Conventional model (VRV III)

Two heat exchanger panels are used. Heat radiation loss from the condenser is high.



VRV R SERIES

The heat exchanger panel utilises a two-split structure (top and bottom), achieving higher heat recovery efficiency than the conventional model.

The size has been reduced by using four heat exchanger panels.

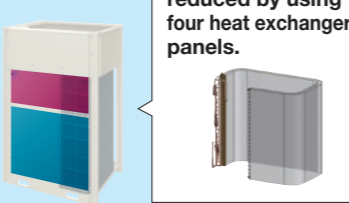

Indoor and outdoor heat balance (conceptual image)

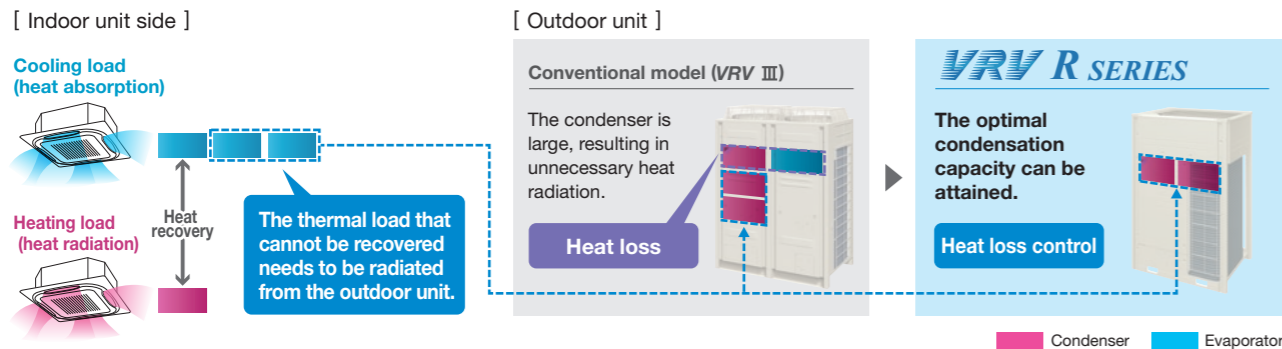

Heat Recovery Link control to reduce the heat loss

Heat loss is minimised by interlocking the heat exchanger switching, motor-operated valves, compressors, and fans, which are conventionally controlled independently during simultaneous cooling and heating operation, leading to a significant increase in efficiency.

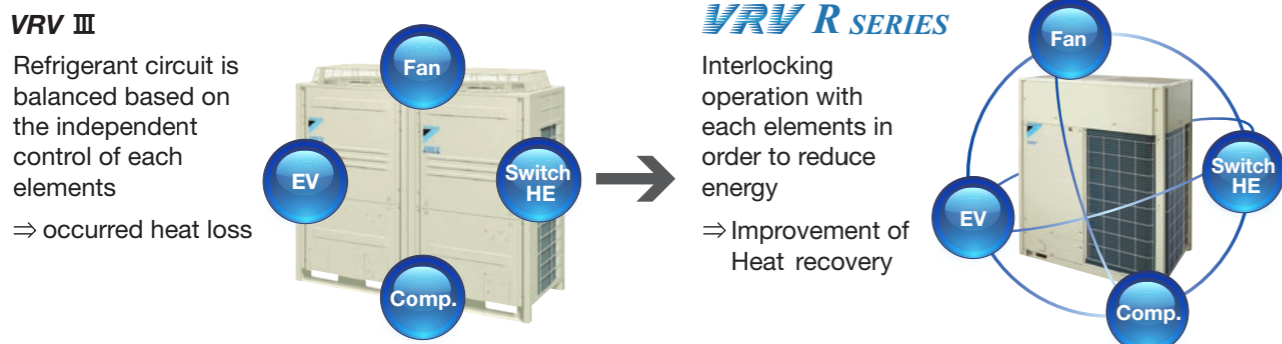

Advanced technologies achieve excellent performance

Highly integrated heat exchanger

Improve performance by increasing heat exchanger area while maintaining the same installation space.

VRV III

Fine Louvre Fin

VRV R SERIES

Waffle Fin

18,20 class (50,56 kW)

3 row with small pipe design, increases heat transfer efficiency

Realise highly integrated heat exchanger performance (increase row, reduce fin pitch) by reducing of airflow resistance which changes cooling tube to Ø7.

Change fin shape from fine louvre to waffle fin. Fin pitch can be reduced fin pitch from 2.0 mm to 1.4 mm, to realise unit efficiency which increased heat exchanger area.

	Heat exchanger area	Contribution of COP (cooling)
16 class (45 kW)	24%UP	108.5%

Various advanced control main PC board

SMT* packaging technology

SMT packaging technology adopted by the whole computer control panel improves the anti-clutter performance.

Protects your computer boards from the adverse effect of sandy and humid weather.

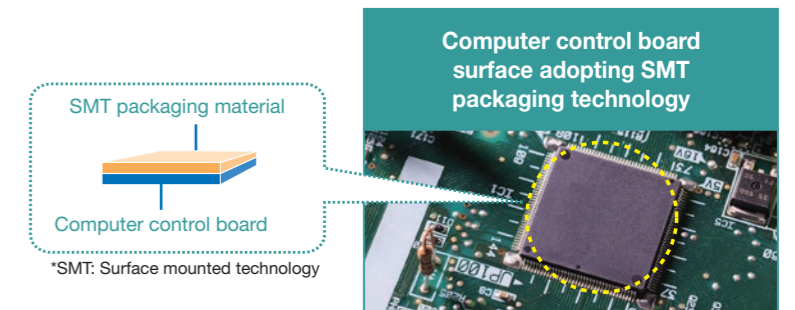

Refrigerant cooling technology, ensures stability of PCB temperature

Improved inner design to increase smooth airflow

Downsize electric component, re-locate to dead space of bell mouth side to decrease airflow resistance.

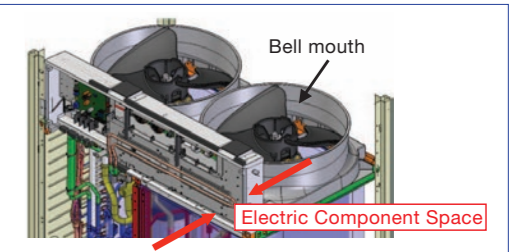

VRV III

Roof terrace temperature in summer is over 40°C, seriously affecting inverter cooling efficiency, resulting in decline of inverter operating speed. Finally device parts response speed is reduced.

VRV R SERIES

Control board failure ratio at stable operation is reduced.

Improve reliability at high ambient temperature

It is possible to cool the inverter power module stability even at high ambient temperature. This helps to keep air-conditioning capacity and also reduces failure ratio.

Individual and centralised BS unit allow greater design flexibility.

Individual BS unit



BSQ100AV1
BSQ160AV1
BSQ250AV1

- Compact and flexible installation
- Flexible design
- Low noise

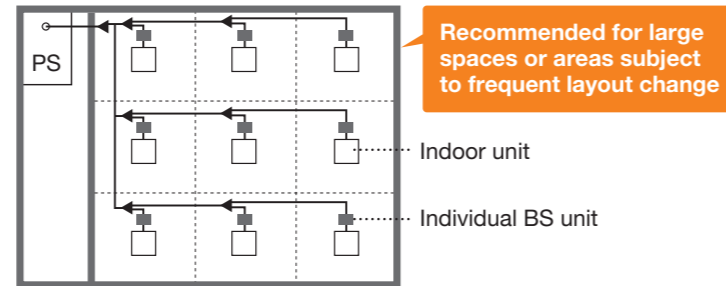

Centralised BS unit



BS4Q14AV1
BS6Q14AV1
BS8Q14AV1
BS10Q14AV1
BS12Q14AV1
BS16Q14AV1

Enhanced Line up

No. of branches	4	6	8	10	12	16
Conventional Centralised BS Unit	●	●				
Centralised BS Unit	●	●	●	●	●	●

Compact and lightweight design

Compared to conventional BS unit (6 branch)

BS unit size **reduced by 65%** BS unit weight **reduced by 73%**

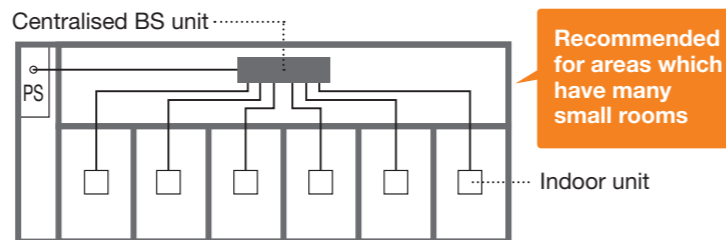

Installation and maintenance work have been made easier through the integration of multiple BS units.

Individual BS unit

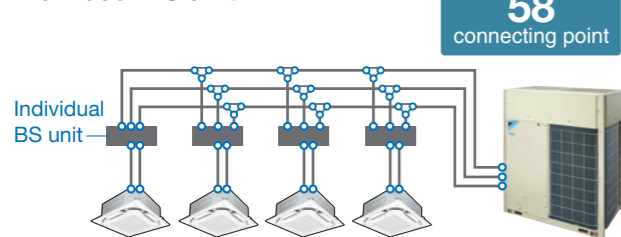

Centralised BS unit

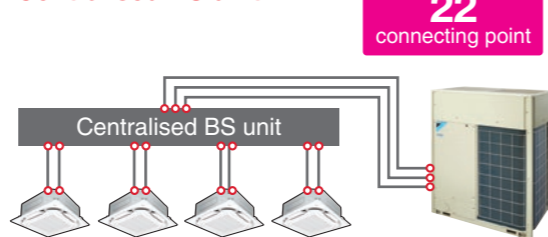

*Centralised BS unit requires drain pipe

Greater design flexibility achieved by increasing the connection capacity range

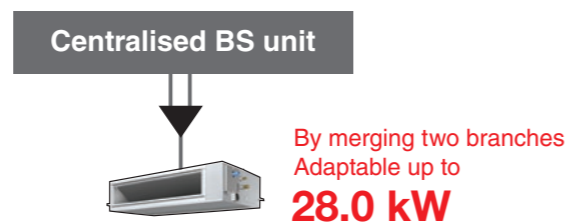
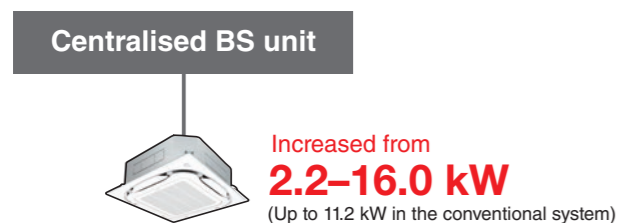

Combined use of a centralised BS unit and individual BS units meets the needs of many design plans.

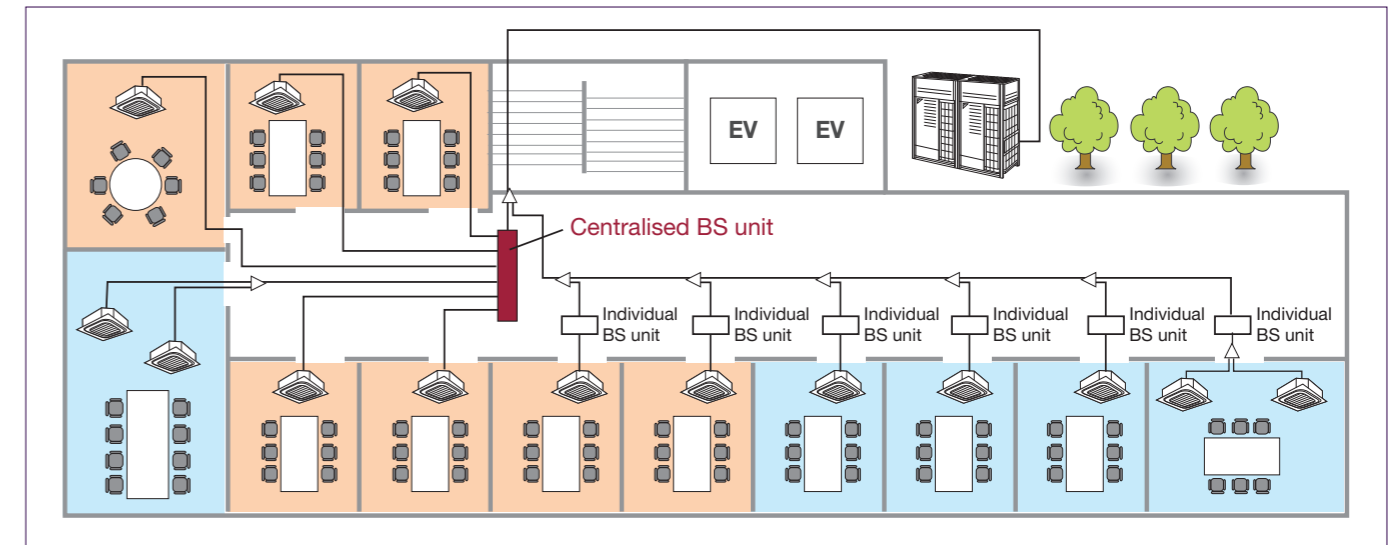

Faster installation of centralised BS unit thanks to open connection

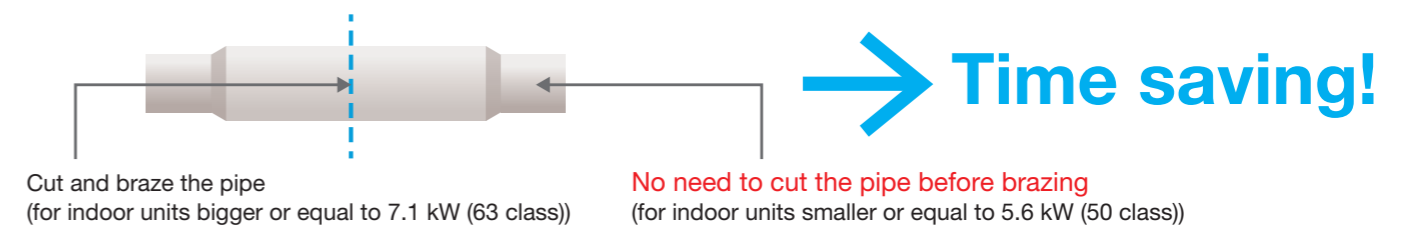

Lower transient sound

New BS units achieve lower transient sound level than conventional BS units.

Maximum transient sound	Sound level (dB(A))*	Centralised BS unit						Individual BS unit		
		4 branch	6 branch	8 branch	10 branch	12 branch	16 branch	100 type	160 type	250 type
New BS units		45	47	47	48	48	49	40	45	45
Conventional BS units		51.5	53.5					45.5	46.5	47.5

*Anechoic chamber conversion value, measured at a point 1 m downward from the unit centre.

More options for equipment placement

Long piping length

The long piping length provides more design flexibility, which can match even large-sized buildings.

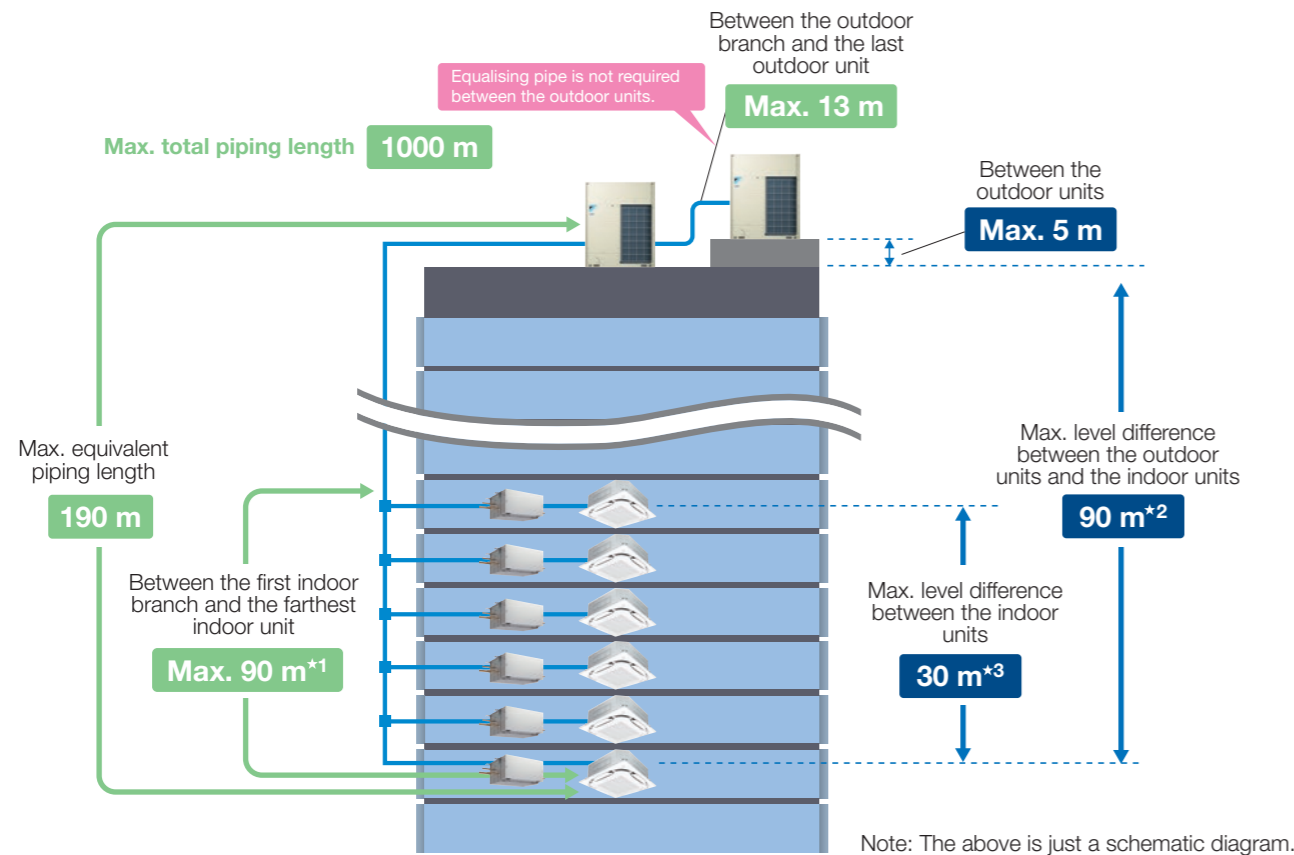

	Actual piping length (Equivalent)	165 m (190 m)
Maximum allowable piping length	Total piping length	1000 m
	Between the first indoor branch and the farthest indoor unit	90 m ^{*1}
	Between the outdoor branch and the last outdoor unit (Equivalent)	10 m (13 m)
Maximum allowable level difference	Between the outdoor units (Multiple use)	5 m
	Between the indoor units	30 m ^{*3}
	Between the outdoor units and the indoor units	90 m ^{*2}

*1. No special requirements up to 40 m. The maximum actual piping length can be 90 m, depending on conditions. The VRV R series is easy to extend to 90 m by lessening the conditions from conventional VRV IV models. Be sure to refer to the Engineering Data Book for details of these conditions and requirements.
 *2. When level differences are 50 m or more, the diameter of the main liquid piping size must be increased. If the outdoor unit is above the indoor unit, a dedicated setting on the outdoor unit is required. Refer to the Engineering Data Book and contact your local dealer for more information.
 *3. When level differences are 15 m or more, maximum actual piping length must be 120 m.

Connection ratio

Connection capacity at maximum is 200%.

Connection ratio
50%–200%

$$\text{Connection ratio} = \frac{\text{Total capacity index of the indoor units}}{\text{Capacity index of the outdoor units}}$$

Conditions of VRV indoor unit connection capacity

Applicable VRV indoor units	FXDQ, FXSQ, FXMQ-PA, FXAQ models	Other VRV indoor unit models ^{*1}
Single outdoor units	200%	200%
Double outdoor units		160%
Triple outdoor units		130%

*1 For the FXF(S)Q25 models, maximum connection ratio is 130% for the entire range of outdoor units.
 Note: If the operational capacity of indoor units is more than 130%, low airflow operation is enforced in all the indoor units.
 *Refer to page 46 for outdoor unit combination details.

High external static pressure

VRV R series outdoor unit has been achieved high external static pressure up to 78.4 Pa, ensuring the efficient heat dissipation and stable operation of equipment in either hierarchical or intensive arrangement.



Wide operation temperature range

The versatile operation range of the VRV R series works to reduce limitations on installation locations. The operation temperature range for heating goes all the way down to -20°C, while cooling can be performed with outdoor temperatures as high as 49°C. Both these achievements are due to the employment of a high-pressure dome-type compressor.

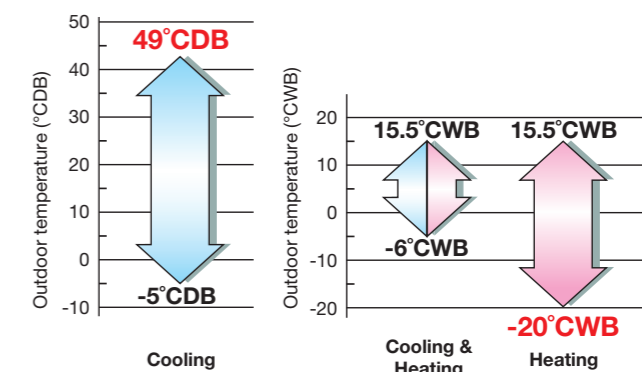

Multiple advanced features ensuring more accurate test operation and stable system

Efficient automatic test operation

Daikin **VRV R** series incorporates a simplified and efficient test operation function, not only greatly accelerating the installation process, but effectively improving the field setting quality as well.

- Automatically checks the wirings between outdoor units and indoor units to confirm whether there is a defective wiring.
- Optimises operations to suit field piping lengths.
- Automatically check whether the stop valve in each outdoor unit is in normal status to ensure the smooth operation of air conditioning system.

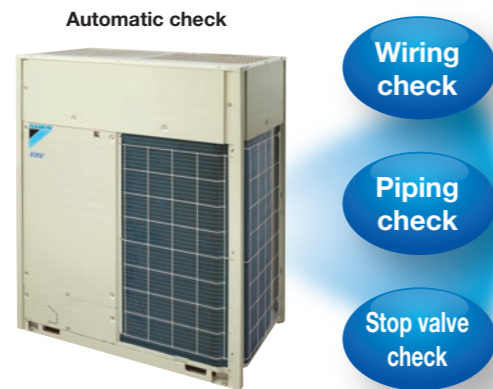

Simplified commissioning and after-sales service

Function of information display by luminous digital tube

VRV R series utilises 7-segment luminous digital tubes to display system operation information, enabling the operational state to be visually displayed whilst facilitating simplified commissioning and after-sales service.

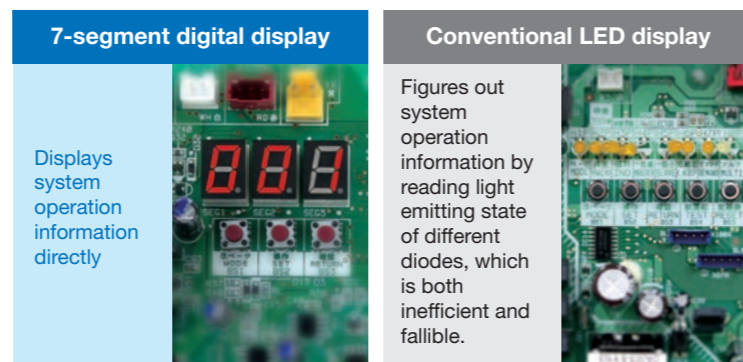

Compliant with the RoHS Directive*

We have been making efforts to facilitate the transition to using RoHS Directive*-compliant materials for system parts.

* RoHS Directive
The RoHS (Restriction of Hazardous Substances (in electrical and electronic equipment)) Directive is an environmental directive enacted to regulate the use of designated chemical substances (lead, cadmium, hexavalent chromium, mercury, polybrominated biphenyls and polybrominated diphenylether) in electrical equipment. All household products subject to this Directive and sold in Europe from July 1, 2006 are legally bound to comply with the RoHS Directive.

Outdoor unit sequencing technology

Automatic sequencing operation

During start-up, Daikin **VRV R** series outdoor unit sequencing operation will be automatically enabled to ensure balanced operation of each outdoor unit to improve longevity of equipment and stable operation.

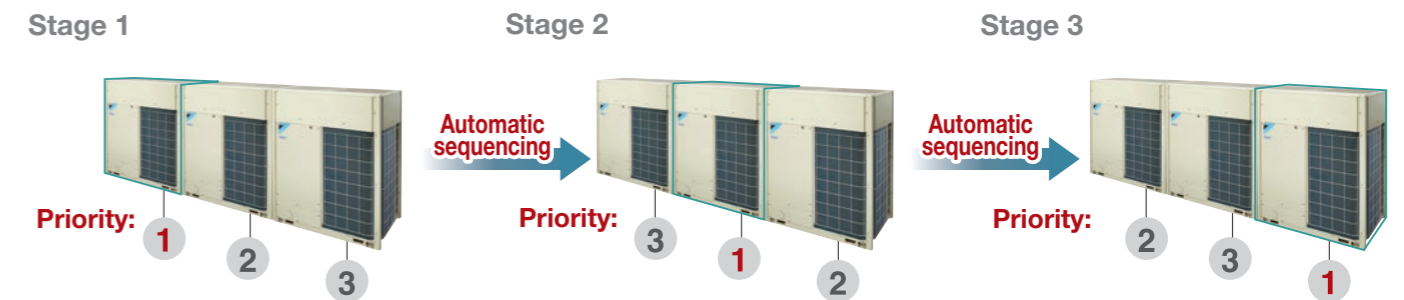

Double backup operation functions responding resiliently to various unexpected situations

Double backup operation functions

Daikin **VRV R** series boasts double backup operation functions, which can secure the use of air conditioners in this area to the greatest extent by emergently enabling double backup operation functions even if failure occurs in a set of air conditioning equipment.

In the event of a failure, emergency operation can be conveniently enabled to allow the remaining system to operate in a limited fashion.

Unit backup operation function

If malfunction occurs in an outdoor unit...
Emergency operation can be conveniently set and enabled by the remote controller for indoor unit (for systems composed of two or more outdoor units).

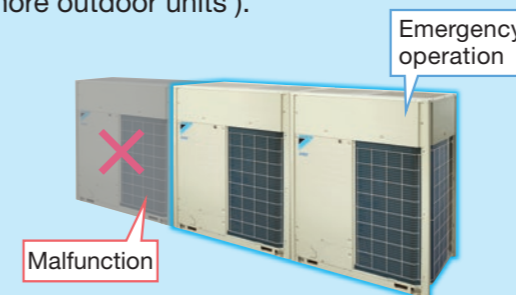

Compressor backup operation function

If malfunction occurs in a compressor...
Emergency operation can be easily set and enabled by the outdoor unit (for a single outdoor unit system REYQ14-20TAY1 models).



VRV R Series Outdoor Units Heat Recovery

Wider capacity range from 6 to 60 class

- With its enhanced lineup of 2 types-High-COP and Standard types, VRV R series Heat Recovery outdoor units offer a wider capacity range from 6 class (16 kW) to 60 class (168 kW) to meet an ever wider variety of needs.
- The single outdoor unit has only 2 different shapes and dimensions, not only simplifying the design process, but also bringing the system design flexibility to a new level.

High-COP Type

- Double Outdoor Units**
12, 14, 16, 18, 20 class

REYQ12TAHY1 REYQ18TAHY1
REYQ14TAHY1 REYQ20TAHY1
REYQ16TAHY1

- Triple Outdoor Units**
22, 24, 26, 28, 30, 32, 34, 36 class

REYQ22TAHY1 REYQ30TAHY1
REYQ24TAHY1 REYQ32TAHY1
REYQ26TAHY1 REYQ34TAHY1
REYQ28TAHY1 REYQ36TAHY1

Standard Type

- Single Outdoor Units**
6, 8, 10, 12 class 14, 16, 18, 20 class

REYQ6TAY1 REYQ14TAY1
REYQ8TAY1 REYQ16TAY1
REYQ10TAY1 REYQ18TAY1
REYQ12TAY1 REYQ20TAY1

- Double Outdoor Units**
22, 24 class 26, 28, 30 class 32, 34, 36 class

REYQ22TAY1 REYQ26TAY1 REYQ32TAY1
REYQ24TAY1 REYQ28TAY1 REYQ34TAY1
REYQ30TAY1 REYQ36TAY1

- Triple Outdoor Units**
38, 40 class 42, 44 class 46, 48, 50, 52, 54, 56, 58, 60 class

REYQ38TAY1 REYQ42TAY1 REYQ46TAY1 REYQ52TAY1 REYQ58TAY1
REYQ40TAY1 REYQ44TAY1 REYQ48TAY1 REYQ54TAY1 REYQ60TAY1
REYQ50TAY1 REYQ56TAY1

Lineup

class		6	8	10	12	14	16	18	20	22	24	26	28	30	32	34	36	38	40	42	44	46	48	50	52	54	56	58	60	
VRV R SERIES	High-COP Type				●	●	●	●	●	●	●	●	●	●	●	●	●													
	Standard Type	●	●	●	●	●	●	●	●	●	●	●	●	●	●	●	●	●	●	●	●	●	●	●	●	●	●	●	●	●

Outdoor Unit Combinations

High-COP Type

class	kW	Capacity index	Model name	Combination	Outdoor unit multi connection piping kit ^{*1}	Total capacity index of connectable indoor units ^{*2}	Maximum number of connectable indoor units ^{*2}
12	32.0	300	REYQ12TAH	REYQ6TA x 2	BHFP26P90	150 to 390 (480)	19 (24)
14	38.4	350	REYQ14TAH	REYQ6TA + REYQ8TA		175 to 455 (560)	22 (28)
16	44.8	400	REYQ16TAH	REYQ8TA x 2		200 to 520 (640)	26 (32)
18	50.4	450	REYQ18TAH	REYQ8TA + REYQ10TA		225 to 585 (720)	29 (36)
20	55.9	500	REYQ20TAH	REYQ8TA + REYQ12TA		250 to 650 (800)	32 (40)
22	60.8	550	REYQ22TAH	REYQ6TA + REYQ8TA x 2	BHFP26P136	275 to 715 (715)	35 (35)
24	67.2	600	REYQ24TAH	REYQ8TA x 3		300 to 780 (780)	39 (39)
26	72.8	650	REYQ26TAH	REYQ8TA x 2 + REYQ10TA		325 to 845 (845)	42 (42)
28	78.3	700	REYQ28TAH	REYQ8TA x 2 + REYQ12TA		350 to 910 (910)	45 (45)
30	83.9	750	REYQ30TAH	REYQ8TA + REYQ10TA + REYQ12TA		375 to 975 (975)	48 (48)
32	89.4	800	REYQ32TAH	REYQ8TA+ REYQ12TA x 2		400 to 1,040 (1,040)	52 (52)
34	95.0	850	REYQ34TAH	REYQ10TA+ REYQ12TA x 2		425 to 1,105 (1,105)	55 (55)
36	101	900	REYQ36TAH	REYQ12TA x 3		450 to 1,170 (1,170)	58 (58)

Note: *1. The outdoor unit multi connection piping kit (separately sold) is required for multiple connection.
*2. Values inside brackets are based on connection of indoor units rated at maximum capacity, 200% for single outdoor units, 160% for double outdoor units, and 130% for triple outdoor units. Refer to page 42 for note on connection capacity of indoor units.





























Standard Type

class	kW	Capacity index	Model name	Combination	Outdoor unit multi connection piping kit ^{*1}	Total capacity index of connectable indoor units ^{*2}	Maximum number of connectable indoor units ^{*2}
6	16.0	150	REYQ6TA	REYQ6TA	-	75 to 195 (300)	9 (15)
8	22.4	200	REYQ8TA	REYQ8TA	-	100 to 260 (400)	13 (20)
10	28.0	250	REYQ10TA	REYQ10TA	-	125 to 325 (500)	16 (25)
12	33.5	300	REYQ12TA	REYQ12TA	-	150 to 390 (600)	19 (30)
14	40.0	350	REYQ14TA	REYQ14TA	-	175 to 455 (700)	22 (35)
16	45.0	400	REYQ16TA	REYQ16TA	-	200 to 520 (800)	26 (40)
18	50.0	450	REYQ18TA	REYQ18TA	-	225 to 585 (900)	29 (45)
20	56.0	500	REYQ20TA	REYQ20TA	-	250 to 650 (1,000)	32 (50)
22	61.5	550	REYQ22TA	REYQ10TA + REYQ12TA	BHFP26P90	275 to 715 (880)	35 (44)
24	67.0	600	REYQ24TA	REYQ12TA x 2		300 to 780 (960)	39 (48)
26	73.5	650	REYQ26TA	REYQ12TA + REYQ14TA		325 to 845 (1,040)	42 (52)
28	78.5	700	REYQ28TA	REYQ12TA + REYQ16TA		350 to 910 (1,120)	45 (56)
30	83.5	750	REYQ30TA	REYQ12TA + REYQ18TA		375 to 975 (1,200)	48 (60)
32	90.0	800	REYQ32TA	REYQ16TA x 2		400 to 1,040 (1,280)	52 (64)
34	95.0	850	REYQ34TA	REYQ16TA + REYQ18TA		425 to 1,105 (1,360)	55 (64)
36	101	900	REYQ36TA	REYQ16TA + REYQ20TA		450 to 1,170 (1,440)	58 (64)
38	107	950	REYQ38TA	REYQ12TA x 2 + REYQ14TA		475 to 1,235 (1,235)	61 (61)
40	112	1,000	REYQ40TA	REYQ12TA x 2 + REYQ16TA		500 to 1,300 (1,300)	BHFP26P136
42	118	1,050	REYQ42TA	REYQ10TA + REYQ16TA x 2	525 to 1,365 (1,365)		
44	124	1,100	REYQ44TA	REYQ12TA + REYQ16TA x 2	550 to 1,430 (1,430)		
46	130	1,150	REYQ46TA	REYQ14TA + REYQ16TA x 2	575 to 1,495 (1,495)		
48	135	1,200	REYQ48TA	REYQ16TA x 3	600 to 1,560 (1,560)		
50	140	1,250	REYQ50TA	REYQ16TA x 2 + REYQ18TA	625 to 1,625 (1,625)	64 (64)	
52	145	1,300	REYQ52TA	REYQ16TA + REYQ18TA x 2	650 to 1,690 (1,690)		
54	150	1,350	REYQ54TA	REYQ18TA x 3	675 to 1,755 (1,755)		
56	156	1,400	REYQ56TA	REYQ18TA x 2 + REYQ20TA	700 to 1,820 (1,820)		
58	162	1,450	REYQ58TA	REYQ18TA + REYQ20TA x 2	725 to 1,885 (1,885)		
60	168	1,500	REYQ60TA	REYQ20TA x 3	750 to 1,950 (1,950)		

Note: *1. For multiple connection of 22 class systems and above, the outdoor unit multi connection piping kit (separately sold) is required.
*2. Values inside brackets are based on connection of indoor units rated at maximum capacity, 200% for single outdoor units, 160% for double outdoor units, and 130% for triple outdoor units. Refer to page 42 for note on connection capacity of indoor units.

Enhanced range of choices

● New lineup  Indoor units subject to VRT smart control

Type	Model Name	Capacity Range(kW)	Capacity Index															
			2.2	2.8	3.6	4.5	5.6	7.1	8	9	11.2	14	16	16.2	18	20	22.4	28
Ceiling Mounted Cassette (Round Flow with Sensing)	FXFSQ-AVM 			●	●	●	●	●		●	●	●	●					
Ceiling Mounted Cassette (Round Flow)	FXFQ-PVE			●	●	●	●	●		●	●	●						
Ceiling Mounted Cassette (Compact Multi Flow)	FXZQ-A2VEB		●	●	●	●	●											
4-Way Flow Ceiling Suspended	FXUQ-AVEB								●		●							
Ceiling Mounted Cassette (Double Flow)	New FXCQ-AVM 		●	●	●	●	●	●		●		●						
Ceiling Mounted Cassette (Single Flow)	FXEQ-AV36		●	●	●	●	●	●										
Slim Ceiling Mounted Duct (Compact Series)	FXDQ-TV1B(A) 		●	●	●	●	●	●										
Slim Ceiling Mounted Duct (Standard Series)	FXDQ-PDVE 	 <small>(700mm width type)</small>	●	●	●													
	FXDQ-NDVE 	 <small>(900 / 1100mm width type)</small>			●	●	●											
Ceiling Concealed Duct	FXDYQ-MAV1									●	●	●	●					
Middle Static Pressure Ceiling Mounted Duct	FXSQ-PAVE 		●	●	●	●	●	●		●	●	●	●					
Ceiling Mounted Duct	FXMQ-PAVE 		●	●	●	●	●	●		●	●	●	●					
	FXMQ-PV1A													●	●	●	●	
Outdoor-Air Processing Unit	FXMQ-MFV1											●				●	●	
Ceiling Suspended	FXHQ-MAVE				●		●			●								
	New FXHQ-AVM											●	●					
Wall Mounted	New FXAQ-AVM 		●	●	●	●	●	●										
Floor Standing	FXLQ-MAVE		●	●	●	●	●	●										
Concealed Floor Standing	FXNQ-MAVE		●	●	●	●	●	●										
Heat Reclaim Ventilator with DX-Coil and Humidifier	VKM-GA(M)V1		Airflow rate 500-1000 m³/h															
Heat Reclaim Ventilator	VAM-GJVE		Airflow rate 150-2000 m³/h															

Note: For indoor units without 'VRT Smart', the standard 'VRT' control is available (excludes Heat Reclaim Ventilators & Outdoor-Air Processing Unit).

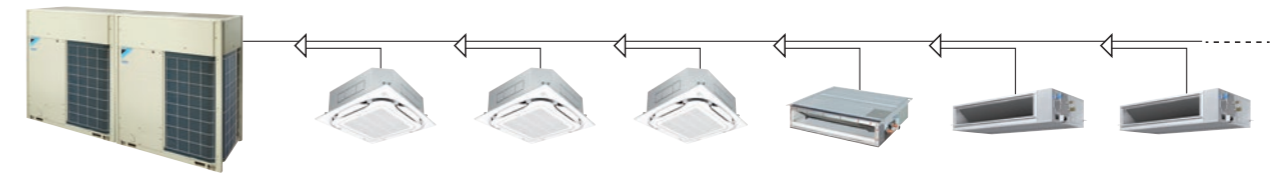

Max. 64 indoor units

- If a system has indoor units subject to both VRT smart and VRT control, the system is operated under VRT control.
- If a system has both outdoor-air processing air conditioners and outdoor-air processing type indoor units, VRT smart control and VRT control are disabled.



VRV R Series Outdoor Units Heat Recovery REYQ-TA

High-COP Type







Model			REYQ12TAHY1	REYQ14TAHY1	REYQ16TAHY1	REYQ18TAHY1	REYQ20TAHY1	REYQ22TAHY1	REYQ24TAHY1	REYQ26TAHY1	REYQ28TAHY1	REYQ30TAHY1					
Combination units			REYQ6TAY1	REYQ6TAY1	REYQ8TAY1	REYQ8TAY1	REYQ8TAY1	REYQ8TAY1	REYQ8TAY1	REYQ8TAY1	REYQ8TAY1	REYQ8TAY1					
			REYQ6TAY1	REYQ8TAY1	REYQ8TAY1	REYQ10TAY1	REYQ12TAY1	REYQ8TAY1	REYQ8TAY1	REYQ10TAY1	REYQ12TAY1	REYQ12TAY1					
Power supply			3-phase 4-wire system, 380-415 V, 50 Hz					3-phase 4-wire system, 380-415 V, 50 Hz									
Cooling capacity	Btu/h		109,000	131,000	153,000	172,000	191,000	207,000	229,000	248,000	267,000	286,000					
	kW		32.0	38.4	44.8	50.4	55.9	60.8	67.2	72.8	78.3	83.9					
Heating capacity	Btu/h		123,000	147,000	171,000	193,000	213,000	232,000	256,000	278,000	299,000	321,000					
	kW		36.0	43.0	50.0	56.5	62.5	68.0	75.0	81.5	87.5	94.0					
Power consumption	Cooling	kW	6.76	8.54	10.3	12.2	13.8	13.7	15.5	17.4	19.0	20.9					
	Heating	kW	7.46	9.41	11.4	13.0	14.9	15.1	17.0	18.7	20.6	22.2					
Capacity control	%		10-100			8-100		7-100			6-100		5-100				
Casing colour			Ivory white (5Y7.5/1)					Ivory white (5Y7.5/1)									
Compressor	Type	Hermetically sealed scroll type															
	Motor output	kW	(2.3x1)+(2.3x1)	(2.3x1)+(3.3x1)	(3.3x1)+(3.3x1)	(3.3x1)+(4.0x1)	(3.3x1)+(4.9x1)	(2.3x1)+(3.3x1)+(3.3x1)	(3.3x1)+(3.3x1)+(3.3x1)	(3.3x1)+(3.3x1)+(4.0x1)	(3.3x1)+(3.3x1)+(4.9x1)	(3.3x1)+(4.0x1)+(4.9x1)					
Airflow rate	ℓ/s		1,983+1,983	1,983+2,633	2,633+2,633	2,633+2,800	2,633+3,000	1,983+2,633+2,633	2,633+2,633+2,633	2,633+2,633+2,800	2,633+2,633+3,000	2,633+2,800+3,000					
	m³/min		119+119	119+158	158+158	158+168	158+180	119+158+158	158+158+158	158+158+168	158+158+180	158+168+180					
Dimensions (HxWxD)	mm		(1,657x930x765)+(1,657x930x765)					(1,657x930x765)+(1,657x930x765)									
Machine weight	kg		215+215		215+230			215+215+215			215+215+230		215+230+230				
Sound level	dB(A)		59			60	61	61			62						
Sound power	dB(A)		80			81	82	82			83						
Operation range	Cooling	°CDB	-5 to 49					-5 to 49									
	Heating	°CWB	-20 to 15.5					-20 to 15.5									
	Cooling & Heating	°CWB	-6 to 15.5					-6 to 15.5									
Refrigerant	Type	R-410A															
	Charge	kg	9.7+9.7		9.7+9.8			9.7+9.9			9.7+9.7+9.7		9.7+9.7+9.8		9.7+9.7+9.9		9.7+9.8+9.9
Piping connections	Liquid	mm	φ12.7 (Brazing)			φ15.9 (Brazing)			φ15.9 (Brazing)			φ19.1 (Brazing)		φ19.1 (Brazing)			
	Gas	mm	φ28.6 (Brazing)			φ28.6 (Brazing)			φ28.6 (Brazing)			φ34.9 (Brazing)		φ34.9 (Brazing)			
	High and low pressure gas	mm	φ19.1 (Brazing)		φ22.2 (Brazing)			φ28.6 (Brazing)			φ28.6 (Brazing)						





Model			REYQ32TAHY1	REYQ34TAHY1	REYQ36TAHY1
Combination units			REYQ8TAY1	REYQ10TAY1	REYQ12TAY1
			REYQ12TAY1	REYQ12TAY1	REYQ12TAY1
Power supply			3-phase 4-wire system, 380-415 V, 50 Hz		
Cooling capacity	Btu/h		305,000	324,000	345,000
	kW		89.4	95.0	101
Heating capacity	Btu/h		341,000	365,000	386,000
	kW		100	107	113
Power consumption	Cooling	kW	22.5	24.4	26.0
	Heating	kW	24.1	25.7	27.7
Capacity control	%		5-100		
Casing colour			Ivory white (5Y7.5/1)		
Compressor	Type	Hermetically sealed scroll type			
	Motor output	kW	(3.3x1)+(4.9x1)+(4.9x1)	(4.0x1)+(4.9x1)+(4.9x1)	(4.9x1)+(4.9x1)+(4.9x1)
Airflow rate	ℓ/s		2,633+3,000+3,000	2,800+3,000+3,000	3,000+3,000+3,000
	m³/min		158+180+180	168+180+180	180+180+180
Dimensions (HxWxD)	mm		(1,657x930x765)+(1,657x930x765)+(1,657x930x765)		
Machine weight	kg		215+230+230		230+230+230
Sound level	dB(A)		63		64
Sound power	dB(A)		84		85
Operation range	Cooling	°CDB	-5 to 49		
	Heating	°CWB	-20 to 15.5		
	Cooling & Heating	°CWB	-6 to 15.5		
Refrigerant	Type	R-410A			
	Charge	kg	9.7+9.9+9.9	9.8+9.9+9.9	9.9+9.9+9.9
Piping connections	Liquid	mm	φ19.1 (Brazing)		
	Gas	mm	φ34.9 (Brazing)		φ41.3 (Brazing)
	High and low pressure gas	mm	φ28.6 (Brazing)		

Note: Specifications are based on the following conditions;

- Cooling: Indoor temp.: 27°CDB, 19°CWB, Outdoor temp.: 35°CDB, Equivalent piping length: 7.5 m, Level difference: 0 m.
 - Heating: Indoor temp.: 20°CDB, Outdoor temp.: 7°CDB, 6°CWB, Equivalent piping length: 7.5 m, Level difference: 0 m.
 - Sound level: Anechoic chamber conversion value, measured at a point 1 m in front of the unit at a height of 1.5 m.
- During actual operation, these values are normally somewhat higher as a result of ambient conditions and oil recovery mode.
When there is concern for noise the surrounding area such as residences, we recommend investigating the installation location and taking soundproofing measures.

VRV R Series Outdoor Units Heat Recovery REYQ-TA Standard Type

																	
Model		REYQ6TAY1	REYQ8TAY1	REYQ10TAY1	REYQ12TAY1	REYQ14TAY1	REYQ16TAY1	REYQ18TAY1	REYQ20TAY1	REYQ22TAY1	REYQ24TAY1	REYQ26TAY1	REYQ28TAY1	REYQ30TAY1	REYQ32TAY1		
Combination units		—	—	—	—	—	—	—	—	REYQ10TAY1	REYQ12TAY1	REYQ12TAY1	REYQ12TAY1	REYQ12TAY1	REYQ16TAY1		
Power supply		3-phase 4-wire system, 380-415 V, 50 Hz						3-phase 4-wire system, 380-415 V, 50 Hz									
Cooling capacity	Btu/h	54,600	76,400	95,500	114,000	136,000	154,000	171,000	191,000	210,000	229,000	251,000	268,000	285,000	307,000		
	kW	16.0	22.4	28.0	33.5	40.0	45.0	50.0	56.0	61.5	67.0	73.5	78.5	83.5	90.0		
Heating capacity	Btu/h	61,400	85,300	107,000	128,000	154,000	171,000	191,000	215,000	235,000	256,000	281,000	299,000	319,000	341,000		
	kW	18.0	25.0	31.5	37.5	45.0	50.0	56.0	63.0	69.0	75.0	82.5	87.5	93.5	100		
Power consumption	Cooling	3.38	5.16	7.04	8.66	10.9	13.0	15.4	18.0	15.7	17.3	19.6	21.7	24.1	26.0		
	Heating	3.73	5.68	7.29	9.22	10.8	12.7	15.0	17.5	16.5	18.4	20.0	21.9	24.2	25.4		
Capacity control	%	20-100		16-100	15-100	11-100	10-100	8-100		6-100		5-100					
Casing colour		Ivory white (5Y7.5/1)						Ivory white (5Y7.5/1)									
Compressor	Type	Hermetically sealed scroll type						Hermetically sealed scroll type									
	Motor output	kW	2.3x1	3.3x1	4.0x1	4.9x1	(3.0x1)+(3.1x1)	(3.4x1)+(3.7x1)	(3.6x1)+(5.0x1)	(4.0x1)+(6.1x1)	(4.0x1)+(4.9x1)	(4.9x1)+(4.9x1)	(4.9x1)+(3.0x1)+(3.1x1)	(4.9x1)+(3.4x1)+(3.7x1)	(4.9x1)+(3.6x1)+(5.0x1)	(3.4x1)+(3.7x1)+(3.4x1)+(3.7x1)	
Airflow rate	l/s	1,983	2,633	2,800	3,000	3,900	3,983	3,767	4,483	2,800+3,000	3,000+3,000	3,000+3,900	3,000+3,983	3,000+3,767	3,983+3,983		
	m³/min	119	158	168	180	234	239	226	269	168+180	180+180	180+234	180+239	180+226	239+239		
Dimensions (HxWxD)	mm	1,657x930x765			1,657x1,240x765			1,657x1,240x765		(1,657x930x765)+(1,657x930x765)		(1,657x930x765)+(1,657x1,240x765)		(1,657x1,240x765)+(1,657x1,240x765)			
Machine weight	kg	215	230	230	230	310	310	342	342	230+230	230+230	230+310	230+342	230+342	310+310		
Sound level	dB(A)	56	57	57	59	60	61	62	65	61	62	63	63	64	64		
Sound power	dB(A)	77	78	78	80	81	82	83	86	82	83	84	84	85	85		
Operation range	Cooling	-5 to 49						-5 to 49									
	Heating	-20 to 15.5						-20 to 15.5									
	Cooling & Heating	-6 to 15.5						-6 to 15.5									
Refrigerant	Type	R-410A						R-410A									
	Charge	kg	9.7	9.8	9.8	9.9	11.8	11.8	9.8+9.9	9.9+9.9	9.9+9.9	9.9+11.8	11.8+11.8				
Piping connections	Liquid	φ9.5 (Brazeing)			φ12.7 (Brazeing)			φ15.9 (Brazeing)		φ19.1 (Brazeing)		φ19.1 (Brazeing)		φ19.1 (Brazeing)			
	Gas	φ19.1 (Brazeing)			φ22.2 (Brazeing)			φ28.6 (Brazeing)		φ28.6 (Brazeing)		φ34.9 (Brazeing)		φ34.9 (Brazeing)			
	High and low pressure gas	φ15.9 (Brazeing)			φ19.1 (Brazeing)			φ22.2 (Brazeing)		φ28.6 (Brazeing)		φ28.6 (Brazeing)		φ28.6 (Brazeing)			

																									
Model		REYQ34TAY1	REYQ36TAY1	REYQ38TAY1	REYQ40TAY1	REYQ42TAY1	REYQ44TAY1	REYQ46TAY1	REYQ48TAY1	REYQ50TAY1	REYQ52TAY1	REYQ54TAY1	REYQ56TAY1	REYQ58TAY1	REYQ60TAY1										
Combination units		REYQ16TAY1	REYQ16TAY1	REYQ12TAY1	REYQ12TAY1	REYQ10TAY1	REYQ12TAY1	REYQ14TAY1	REYQ16TAY1	REYQ16TAY1	REYQ16TAY1	REYQ18TAY1	REYQ18TAY1	REYQ18TAY1	REYQ20TAY1										
Power supply		3-phase 4-wire system, 380-415 V, 50 Hz						3-phase 4-wire system, 380-415 V, 50 Hz																	
Cooling capacity	Btu/h	324,000	345,000	365,000	382,000	403,000	423,000	444,000	461,000	478,000	495,000	512,000	532,000	553,000	573,000										
	kW	95.0	101	107	112	118	124	130	135	140	145	150	156	162	168										
Heating capacity	Btu/h	362,000	386,000	409,000	427,000	450,000	471,000	495,000	512,000	532,000	553,000	573,000	597,000	621,000	645,000										
	kW	106	113	120	125	132	138	145	150	156	162	168	175	182	189										
Power consumption	Cooling	28.4	31.0	28.2	30.3	33.0	34.7	36.9	39.0	41.4	43.8	46.2	48.8	51.4	54.0										
	Heating	27.7	30.2	29.2	31.1	32.7	34.6	36.2	38.1	40.4	42.7	45.0	47.5	50.0	52.5										
Capacity control	%	4-100						3-100																	
Casing colour		Ivory white (5Y7.5/1)						Ivory white (5Y7.5/1)																	
Compressor	Type	Hermetically sealed scroll type						Hermetically sealed scroll type																	
	Motor output	kW	(3.4x1)+(3.7x1)+(3.6x1)+(5.0x1)	(3.4x1)+(3.7x1)+(4.0x1)+(6.1x1)	(4.9x1)+(4.9x1)+(3.0x1)+(3.1x1)	(4.9x1)+(4.9x1)+(3.4x1)+(3.7x1)	(4.0x1)+(3.4x1)+(3.7x1)+(3.4x1)+(3.7x1)	(4.9x1)+(3.4x1)+(3.7x1)+(3.4x1)+(3.7x1)	(3.0x1)+(3.1x1)+(3.4x1)+(3.7x1)+(3.4x1)+(3.7x1)	(3.4x1)+(3.7x1)+(3.4x1)+(3.7x1)+(3.4x1)+(3.7x1)	(3.4x1)+(3.7x1)+(3.4x1)+(3.7x1)+(3.6x1)+(5.0x1)	(3.4x1)+(3.7x1)+(3.6x1)+(5.0x1)	(3.6x1)+(5.0x1)+(3.6x1)+(5.0x1)+(3.6x1)+(5.0x1)	(3.6x1)+(5.0x1)+(3.6x1)+(5.0x1)+(4.0x1)+(6.1x1)	(3.6x1)+(5.0x1)+(4.0x1)+(6.1x1)	(4.0x1)+(6.1x1)+(4.0x1)+(6.1x1)+(4.0x1)+(6.1x1)									
Airflow rate	l/s	3,983+3,767	3,983+4,483	3,000+3,000+3,900	3,000+3,000+3,983	2,800+3,983+3,983	3,000+3,983+3,983	3,900+3,983+3,983	3,983+3,983+3,983	3,983+3,983+3,767	3,983+3,767+3,767	3,767+3,767+3,767	3,767+3,767+4,483	3,767+4,483+4,483	4,483+4,483+4,483										
	m³/min	239+226	239+269	180+180+234	180+180+239	168+239+239	180+239+239	234+239+239	239+239+239	239+239+226	239+226+226	226+226+226	226+226+269	226+269+269	269+269+269										
Dimensions (HxWxD)	mm	(1,657x1,240x765)+(1,657x1,240x765)		(1,657x930x765)+(1,657x930x765)+(1,657x1,240x765)		(1,657x930x765)+(1,657x1,240x765)+(1,657x1,240x765)		(1,657x1,240x765)+(1,657x1,240x765)+(1,657x1,240x765)																	
Machine weight	kg	310+342		230+230+310		230+310+310		310+310+310		310+310+342		310+342+342		342+342+342											
Sound level	dB(A)	65	66	64	65	65	65	65	66	66	67	68	69	70	70										
Sound power	dB(A)	86	87	85	86	86	86	86	87	87	88	89	90	91	91										
Operation range	Cooling	-5 to 49						-5 to 49																	
	Heating	-20 to 15.5						-20 to 15.5																	
	Cooling & Heating	-6 to 15.5						-6 to 15.5																	
Refrigerant	Type	R-410A						R-410A																	
	Charge	kg	11.8+11.8		9.9+9.9+11.8		9.8+11.8+11.8		9.9+11.8+11.8		11.8+11.8+11.8		11.8+11.8+11.8												
Piping connections	Liquid	φ34.9 (Brazeing)			φ41.3 (Brazeing)			φ41.3 (Brazeing)		φ41.3 (Brazeing)		φ41.3 (Brazeing)		φ41.3 (Brazeing)											
	Gas	φ28.6 (Brazeing)			φ34.9 (Brazeing)			φ34.9 (Brazeing)		φ34.9 (Brazeing)		φ34.9 (Brazeing)		φ34.9 (Brazeing)											
	High and low pressure gas	φ28.6 (Brazeing)			φ34.9 (Brazeing)			φ34.9 (Brazeing)		φ34.9 (Brazeing)		φ34.9 (Brazeing)		φ34.9 (Brazeing)											

Note: Specifications are based on the following conditions:
 •Cooling: Indoor temp.: 27°CDB, 19°CWB, Outdoor temp.: 35°CDB, Equivalent piping length: 7.5 m, Level difference: 0 m.
 •Heating: Indoor temp.: 20°CDB, Outdoor temp.: 7°CDB, 6°CWB, Equivalent piping length: 7.5 m, Level difference: 0 m.
 •Sound level: Anechoic chamber conversion value, measured at a point 1 m in front of the unit at a height of 1.5 m.
 During actual operation, these values are normally somewhat higher as a result of ambient conditions and oil recovery mode.
 When there is concern for noise the surrounding area such as residences, we recommend investigating the installation location and taking soundproofing measures.

VRV R SERIES Heat Recovery



Heat Pump
3.5 class-9 class
 (9 kW) (24 kW)

Compact & lightweight design

The new design has been optimised for the VRV IV S series, with the height of 3.5 class to 5 class models reduced to only 990 mm. This design gives the building a sleek look externally and provides the occupants with a clear, unobstructed view of the scenery. The VRV IV S series is now slim and compact, with outdoor units that require minimal installation space.

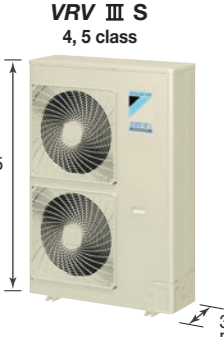
 <p>VRV III S 4, 5 class</p> <p>1,345 mm</p> <p>320 mm</p>	 <p>VRV IV S SERIES 3.5, 4, 5 class</p> <p>990 mm</p> <p>320 mm</p>	<p>VRV III S 4 class (11.2 kW)</p> <p>Height 1,345 mm</p> <p>Product Weight 125 kg</p>	<p>VRV IV S SERIES 4 class (11.2 kW)</p> <p>Height 990 mm 26% Decrease</p> <p>Product Weight 71 kg 43% Decrease</p>
 <p>VRV IV 8 class</p> <p>1,657 mm</p> <p>930 mm</p> <p>765 mm</p>	 <p>VRV IV S SERIES 8 class</p> <p>1,430 mm</p> <p>940 mm</p> <p>320 mm</p>	<p>VRV IV 8 class (22.4 kW)</p> <p>Height 1,657 mm</p> <p>Product Weight 185 kg</p> <p>Footprint 0.71 m²</p>	<p>VRV IV S SERIES 8 class (22.4 kW)</p> <p>Height 1,430 mm 14% Decrease</p> <p>Product Weight 138 kg 25% Decrease</p> <p>Footprint 0.30 m² 58% Decrease</p>

Enhanced lineup

To suit a variety of room sizes, VRV IV S series expands our range to include 3.5 class, 8 class and 9 class.

VRV IV S SERIES



3.5 class 4 class 5 class 6 class 8 class 9 class

Lineup

Model Name	RXYMQ3AV4A	RXYMQ4AV4A	RXYMQ5AV4A	RXYMQ6AV4A	RXYMQ8AY1	RXYMQ9AY1
Power Supply	1-phase, 230-240 V, 50 Hz				3-phase, 380-415 V, 50 Hz	
Capacity Range	3.5 class (9.0 kW)	4 class (11.2 kW)	5 class (14.0 kW)	6 class (16.0 kW)	8 class (22.4 kW)	9 class (24.0 kW)
Capacity Index	80	100	125	150	200	215

Wide variety of indoor units

Indoor units can be selected from 2 lineups, both VRV and residential indoor units, to match rooms and preferences. A mixed combination of VRV indoor units and residential indoor units can be included into one system, opening the door to stylish and quiet indoor units.



Energy saving

Higher Coefficient of Performance (COP)

VRV IV S series provides greater energy saving as compared to VRV III S series, especially for 6 class.

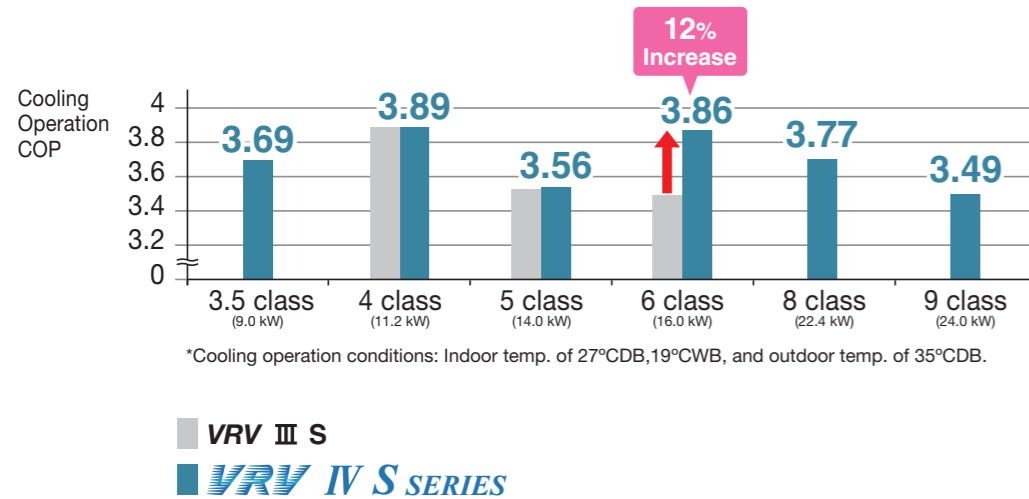

Quiet operation

Nighttime quiet operation function

Operation sound level selectable from 3 steps for the night mode

Mode 1. Automatic mode

Set on the outdoor PCB. Time of maximum temperature is memorised. The low operating mode will initiate 8 hours*1 after the peak temperature in the daytime, and normal operation will resume 10 hours*2 after that. The operation sound level for the night mode can be selected from 49 dB(A) (Step 1), 46 dB(A) (Step 2) and 43 dB(A) (Step 3).*3

Mode 2. Manual mode

Starting time and ending time can be input. (An external control adaptor for outdoor unit, DTA104A53/61/62, and a locally obtained timer are necessary.)

Mode 3. Combined mode

Combinations of modes 1 and 2 can be used depending on your needs.

*1. Initial setting. Can be selected from 6, 8 and 10 hours.
*2. Initial setting. Can be selected from 8, 9 and 10 hours.
*3. In case of 4 class outdoor unit during cooling operation

Mode 1. Automatic mode

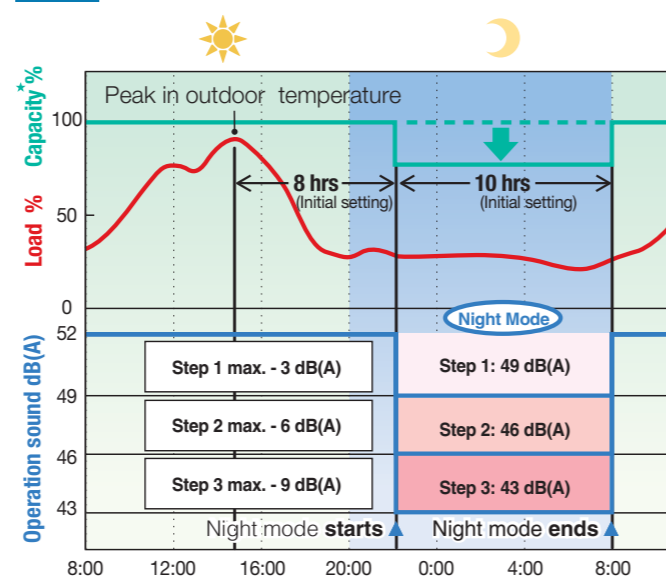

Note: • This function is available in setting at site.
• The relationship of outdoor temperature (load) and time shown in the graph is just an example.
* The capacity reduction rate differs depending on the operation sound level step selected.

Collection of cutting-edge technologies realises efficient and quiet operation

The high efficiency compressor to achieve a higher COP

1 Compressor equipped with Reluctance DC motor

Daikin DC inverter models are equipped with the Reluctance DC motor for compressor. The Reluctance DC motor uses 2 different types of torque, neodymium magnet*1 and reluctance torque*2. This motor can save energy because it generates more power with a smaller electric power than an AC or conventional DC motor.

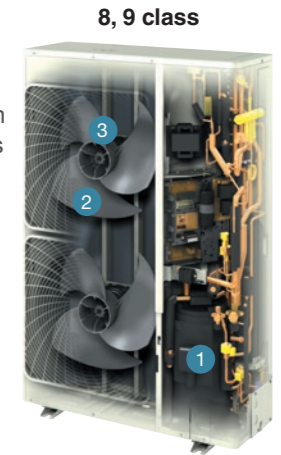
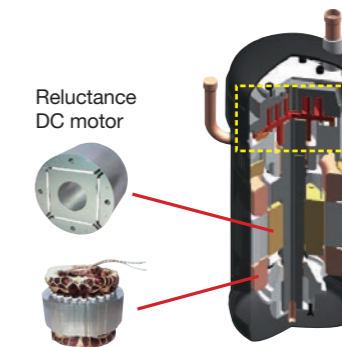
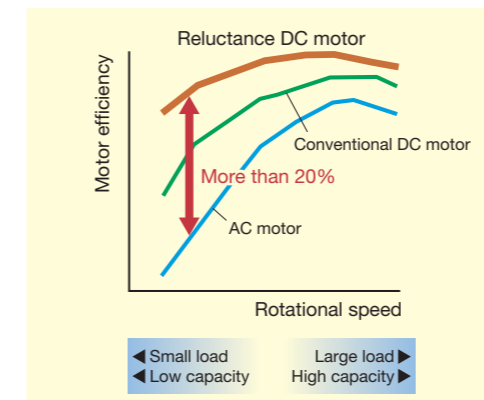

Note: Data are based on studies conducted under controlled conditions at a Daikin laboratory using Daikin products.

*1 A neodymium magnet is approximately 10 times stronger than a standard ferrite magnet.
*2 The torque created by the change in power between the iron and magnet parts.

>> Smooth sine wave DC inverter

Use of an optimised sine wave smoothes motor rotation, further improving operating efficiency.

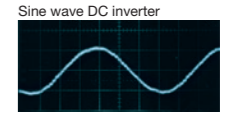

RXYMQ3, 4, 5, 6AV4A

>> Swing compressor

Daikin swing compressor has integrated the rotor with the blade, completely solving the refrigerant leakage and the wear problem caused by the mechanical friction between the rotor and the blade, which enhances the compressor efficiency and makes the compressor more quiet and durable.



RXYMQ8, 9AY1

>> The structural scroll

Sucked gas is compressed in the scrolling part before the heated motor, so that the machine compresses the non-expanded gas, resulting in high efficiency compression.

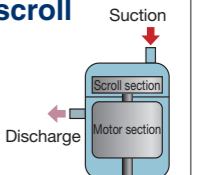

2 Smooth Air Inlet Bell Mouth and Aero Spiral Fan

These two features work to reduce sound. Guides are added to the bell mouth intake to reduce turbulence in the airflow generated by fan suction. The Aero Spiral Fan features fan blades with the bent blade edges, further reducing turbulence.

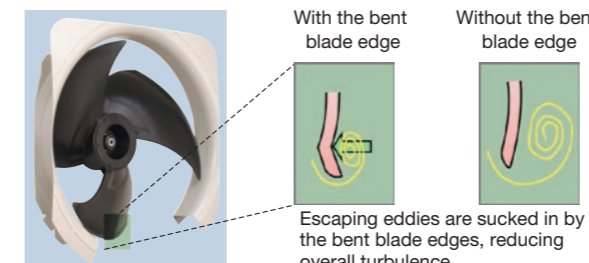

3 DC fan motor

Efficiency improved in all areas compared to conventional AC motors, especially at low speeds.

DC fan motor structure

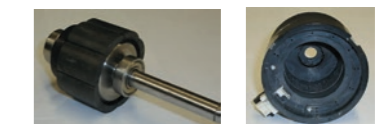

Connectable up to 14 indoor units

As many as 14 indoor units can be connected to a single outdoor unit, making the VRV IV S series a remarkably versatile system.

Note: Refer to page 61 for the maximum number of connectable indoor unit.

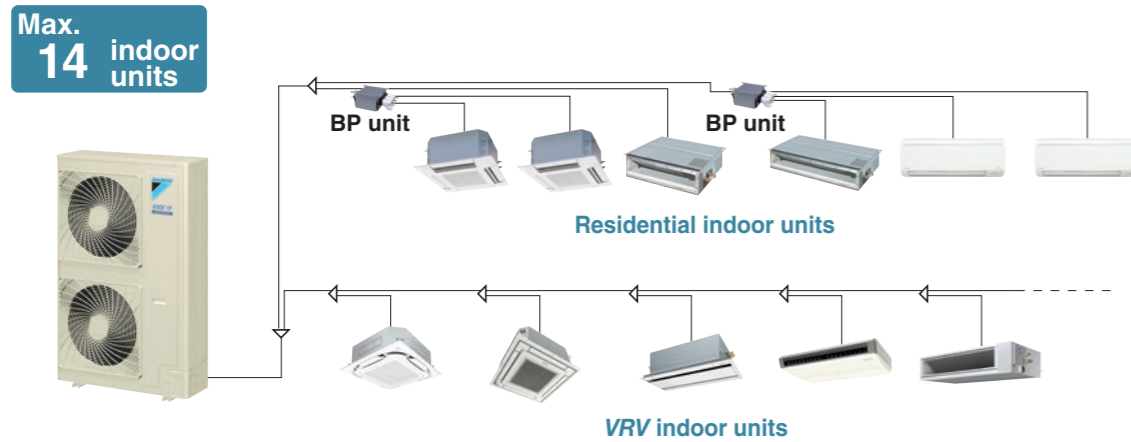

Automatic test operation

Simply press the test operation button and the unit performs an automatic system check, including wiring, stop valves, piping, and refrigerant charging amount. The results are returned automatically after the check finishes.

Simple wiring and piping connection

Unique piping and wiring systems make it possible to install a VRV IV S series quickly and easily.

>> Super wiring system

A super wiring system is used to enable shared use of the wiring between indoor and outdoor units and the central control wiring, with a relatively simple wiring operation. The DIII-NET communication system is employed to enable the use of advanced control systems.

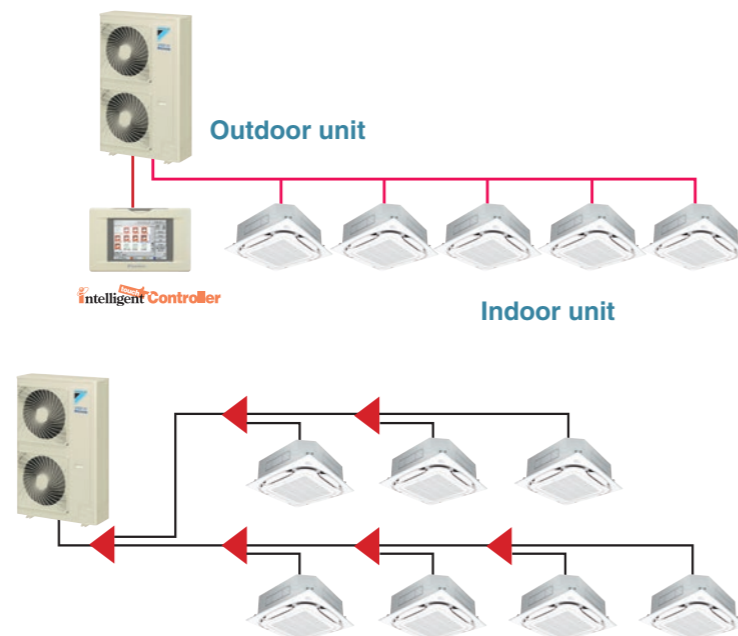

>> REFNET piping system

Daikin's advanced REFNET piping system makes installation easy. Only two main refrigerant lines are required in any one system. REFNET greatly reduces the imbalances in refrigerant flow between units, while using small-diameter piping.

Long piping design possible

Long piping length offers flexibility in the choice of installation positions, and simplifies system planning.

When only VRV indoor units are connected

Actual piping length
Max. 120 m

Total piping length
Max. 300 m

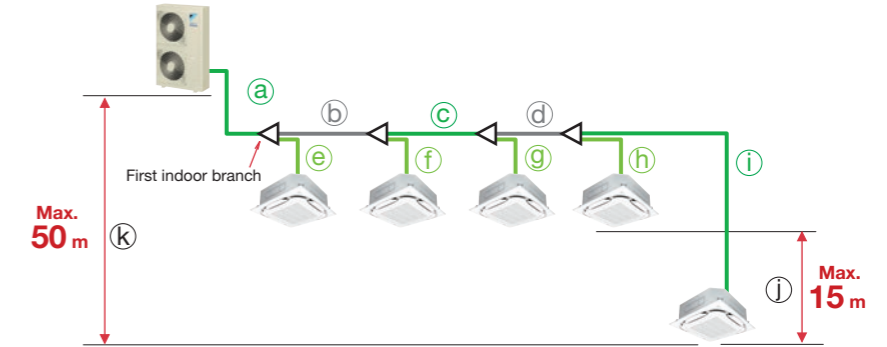

			3.5,4 class	5 class	6 class	8,9 class	
Max. allowable piping length	Refrigerant piping length	a+b+c+d+i	70 m	70 m	120 m	100 m	
	Equivalent piping length		90 m	90 m	150 m	130 m	
	Total piping length	a+b+c+d+e+f+g+h+i	250 m	300 m	300 m	300 m	
	Between the first indoor branch and the farthest indoor unit	b+c+d+i	40 m	40 m	40 m	40 m	
Max. allowable level difference	Between the indoor units	j	10 m	15 m	15 m	15 m	
	Between the outdoor unit and the indoor unit	If the outdoor unit is above	k	30 m	30 m	50 m	50 m
		If the outdoor unit is below	k	30 m	30 m	40 m	40 m

When a mixed combination of VRV and residential indoor units is connected or when only residential indoor units are connected

Actual piping length
Max. 100 m

Total piping length
Max. 250 m

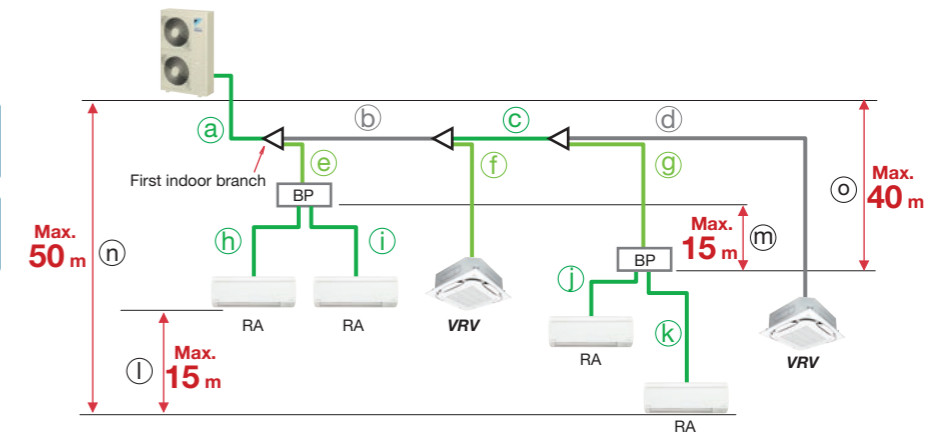

			3.5,4 class	5 class	6-9 class	
Max. allowable piping length	Refrigerant piping length	a+b+c+g+k, a+b+c+d	70 m	70 m	100 m	
	Equivalent piping length		90 m	90 m	125 m	
	Total piping length	a+b+c+d+e+f+g+h+i+j+k	250 m	250 m	250 m	
	The first indoor branch - the farthest BP or VRV indoor unit	b+c+g, b+c+d	40 m	40 m	40 m	
Max. & min. allowable piping length	BP unit - indoor unit	If indoor unit capacity index < 60	2 m-15 m	2 m-15 m	2 m-15 m	
		If indoor unit capacity index is 60	2 m-12 m	2 m-12 m	2 m-12 m	
		If indoor unit capacity index is 71	2 m-8 m	2 m-8 m	2 m-8 m	
Min. allowable piping length	Outdoor unit - the first indoor branch	a	5 m	5 m	5 m	
Max. allowable level difference	Between the indoor units	l	10 m	15 m	15 m	
	Between BP units	m	10 m	15 m	15 m	
	Outdoor unit - the indoor unit	If the outdoor unit is above	n	30 m	30 m	50 m
		If the outdoor unit is below	n	30 m	30 m	40 m
	Outdoor unit - the BP unit	o	30 m	30 m	40 m	

Enhanced range of choices

A mixed combination of **VRV** indoor units and residential indoor units can be included into one system, opening the door to stylish and quiet indoor units.

VRV indoor units

● New lineup

Type	Model Name	Capacity Range(kW)	20	25	32	40	50	63	71	80	100	125	140	145	160	180	200	250
			2.2	2.8	3.6	4.5	5.6	7.1	8	9	11.2	14	16	16.2	18	20	22.4	28
			Capacity Index	20	25	31.25	40	50	62.5	71	80	100	125	140	145	160	180	200
Ceiling Mounted Cassette (Round Flow with Sensing)	FXFSQ-AVM		●	●	●	●	●			●	●	●	●					
Ceiling Mounted Cassette (Round Flow)	FXFQ-PVE		●	●	●	●	●			●	●	●						
Ceiling Mounted Cassette (Compact Multi Flow)	FXZQ-A2VEB		●	●	●	●	●											
4-Way Flow Ceiling Suspended	FXUQ-AVEB								●		●							
Ceiling Mounted Cassette (Double Flow)	New FXCQ-AVM		●	●	●	●	●	●		●		●						
Ceiling Mounted Cassette (Single Flow)	FXEQ-AV36		●	●	●	●	●	●										
Slim Ceiling Mounted Duct (Compact Series)	FXDQ-TV1B(A)		●	●	●	●	●	●										
Slim Ceiling Mounted Duct (Standard Series)	FXDQ-PDVE (700mm width type)		●	●	●													
	FXDQ-NDVE (900 / 1100mm width type)					●	●	●										
Ceiling Concealed Duct	FXDYQ-MAV1									●	●	●		●				
Middle Static Pressure Ceiling Mounted Duct	FXSQ-PAVE		●	●	●	●	●	●		●	●	●	●					
Ceiling Mounted Duct	FXMQ-PAVE		●	●	●	●	●	●		●	●	●	●					
	FXMQ-PV1A														●	●	●	●
Outdoor-Air Processing Unit	FXMQ-MFV1											●						●
Ceiling Suspended	FXHQ-MAVE			●				●			●							
	New FXHQ-AVM											●	●					
Wall Mounted	New FXAQ-AVM		●	●	●	●	●	●										
Floor Standing	FXLQ-MAVE		●	●	●	●	●	●										
Concealed Floor Standing	FXNQ-MAVE		●	●	●	●	●	●										
Heat Reclaim Ventilator	VAM-GJVE		Airflow rate 150-2000 m³/h															

Residential indoor units with connection to BP units

Type	Model Name	Rated Capacity (kW)	20	25	35	50	60	71
			2.0	2.5	3.5	5.0	6.0	7.1
			Capacity Index	20	25	35	50	60
Ceiling Mounted Cassette (Compact Multi Flow)	FFQ-BV1B			●	●	●	●	
Slim Ceiling Mounted Duct	FDXS-CVMA (900/1,100 mm width type)			●	●	●	●	
Wall Mounted	FTXS-KVMA		●	●	●			
	FTXS-KAVMA					●	●	●

Note: BP units are necessary for residential indoor units.

VRV indoor units combine with residential indoor units, all in one system.



*Refer to page 61 for the maximum number of connectable indoor units.

VRV IV S SERIES Heat Pump

VRV IV S Series Outdoor Units Heat Pump RXYMQ-A

MODEL		RXYMQ3AV4A	RXYMQ4AV4A	RXYMQ5AV4A	RXYMQ6AV4A	RXYMQ8AY1	RXYMQ9AY1
Power supply		1-phase, 230-240 V, 50 Hz				3-phase, 380-415 V, 50 Hz	
Cooling capacity	Btu/h	30,700	38,200	47,800	54,600	76,400	81,900
	kW	9.0	11.2	14.0	16.0	22.4	24.0
Heating capacity	Btu/h	34,100	42,700	47,800	61,400	85,300	88,700
	kW	10.0	12.5	14.0	18.0	25.0	26.0
Power consumption	Cooling	2.44	2.88	3.93	4.14	5.94	6.88
	Heating	2.28	2.60	3.04	4.07	6.25	6.82
Capacity control	%	24 to 100		16 to 100		20 to 100	
Casing colour		Ivory white (5Y7.5/1)					
Compressor	Type	Hermetically sealed swing type			Hermetically sealed scroll type		
	Motor output	1.92	3.0	3.5	3.8	4.8	
Airflow rate	ℓ/s	1,267			1,767	2,333	
	m³/min	76			106	140	
Dimensions (H x W x D)	mm	990 x 940 x 320			1,345 x 900 x 320	1,430 x 940 x 320	
Machine weight	kg	71		82	104	138	
Sound level (Cooling/Heating)	dB(A)	51/52	52/54	53/54	55/56	57/58	58/59
Sound power	dB(A)	69	70	71	73	75	76
Operation range	Cooling	°CDB -5 to 46					
	Heating	°CWB -20 to 15.5					
Refrigerant	Type	R-410A					
	Charge	2.9	3.4	3.6	5.8		
Piping connections	Liquid	φ 9.5 (Flare)				φ 9.5 (Brazing)	
	Gas	φ 15.9 (Flare)		φ 19.1 (Flare)	φ 19.1 (Brazing)	φ 22.2 (Brazing)	

Note: Specifications are based on the following conditions:
 • Cooling: Indoor temp.: 27°CDB, 19°CWB, Outdoor temp.: 35°CDB, Equivalent piping length: 7.5 m, Level difference: 0 m.
 • Heating: Indoor temp.: 20°CDB, Outdoor temp.: 7°CDB, 6°CWB, Equivalent piping length: 7.5 m, Level difference: 0 m.
 • Sound level: Anechoic chamber conversion value, measured at a point 1 m in front of the unit at a height of 1.5 m.
 During actual operation, these values are normally somewhat higher as a result of ambient conditions and oil recovery mode.
 When there is concern for noise the surrounding area such as residences, we recommend investigating the installation location and taking soundproofing measures.
 • Refrigerant charge is required.

VRV III S Series Outdoor Units Heat Pump RXYMQ-P

MODEL		RXYMQ5PV4A	
Power supply		1-phase, 230-240 V, 50 Hz	
Cooling capacity	Btu/h	47,800	
	kW	14.0	
Heating capacity	Btu/h	54,600	
	kW	16.0	
Power consumption	Cooling	3.97	
	Heating	4.09	
Capacity control	%	24 to 100	
Casing colour		Ivory white (5Y7.5/1)	
Compressor	Type	Hermetically sealed scroll type	
	Motor output	kW 3.0	
Airflow rate	ℓ/s	1,767	
	m³/min	106	
Dimensions (H x W x D)	mm	1,345 x 900 x 320	
Machine weight	kg	125	
Sound level (Cooling/Heating)	dB(A)	51/53	
Sound power	dB(A)	69	
Operation range	Cooling	°CDB -5 to 46	
	Heating	°CWB -20 to 15.5	
Refrigerant	Type	R-410A	
	Charge	kg 4.0	
Piping connections	Liquid	φ 9.5 (Flare)	
	Gas	φ 15.9 (Flare)	

Note: Specifications are based on the following conditions:
 • Cooling: Indoor temp.: 27°CDB, 19.5°CWB, Outdoor temp.: 35°CDB, Equivalent piping length: 7.5 m, Level difference: 0 m.
 • Heating: Indoor temp.: 20°CDB, Outdoor temp.: 7°CDB, 6°CWB, Equivalent piping length: 7.5 m, Level difference: 0 m.
 • Sound level: Anechoic chamber conversion value, measured at a point 1 m in front of the unit at a height of 1.5 m.
 During actual operation, these values are normally somewhat higher as a result of ambient conditions and oil recovery mode.
 When there is concern for noise the surrounding area such as residences, we recommend investigating the installation location and taking soundproofing measures.
 • Refrigerant charge is required.

Please refer to the VRV III S series brochure and Engineering Data Book for more information.

Outdoor Unit Combinations

Model	kW	Class	Capacity index	Total capacity index of connectable indoor units				Maximum number of connectable indoor units
				Combination (%)				
				50% ¹	80% ²	100% ³	130%	
RXYMQ3AV4A	9.0	3.5	80	40	64	80	104	5
RXYMQ4AV4A	11.2	4	100	50	80	100	130	6
RXYMQ5AV4A	14.0	5	125	62.5	100	125	162.5	8
RXYMQ6AV4A	16.0	6	150	75	120	150	195	9
RXYMQ8AY1	22.4	8	200	100	160	200	260	13
RXYMQ9AY1	24.0	9	215	107.5	172	215	280	14

Note: ¹ When only VRV indoor units are connected, connection ratio must be 50% to 130%.
² When a mixed combination of VRV and residential indoor units is connected or when only residential indoor units are connected, connection ratio must be 80% to 130%.
³ When outdoor-air processing unit is connected, connection ratio must be 50% to 100%. A mixed combination of the outdoor-air processing unit and standard indoor unit in one system is not allowed.

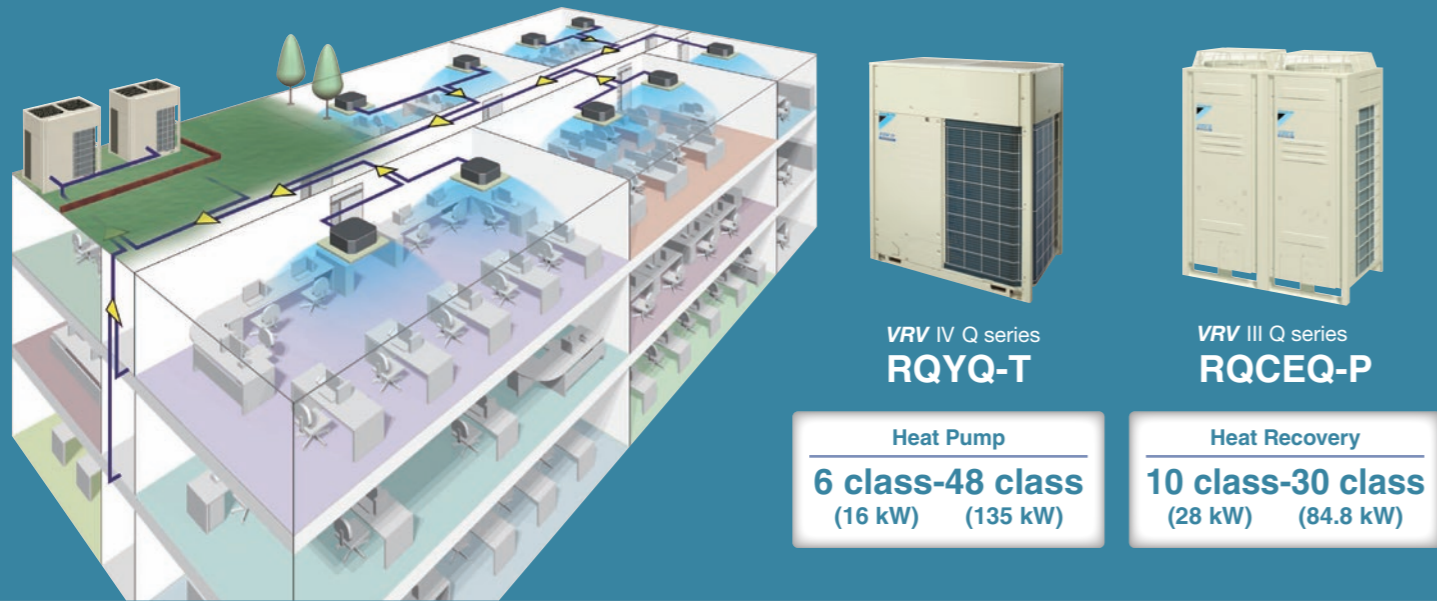

Reusing existing piping for speedy replacement to an advanced energy-saving air conditioning system

Upgrading air conditioning systems in the past used to require replacement of refrigerant piping in buildings, leading to major construction and costs exceeding those of the original installation. To save time and cost, Daikin developed the VRV IV Q Series as a model specializing in system replacement. This revolutionary system reuses existing piping and enables quick and high quality replacement to the latest energy-saving air conditioning system without renovation work for new piping.

The VRV IV Q SERIES concept

Reusing existing refrigerant piping minimizes:

- Piping removal and new construction along with installation time and cost
- Impact to the interior and exterior of buildings
- Suspension of daily business operations for renovation

Improvement in capacity and greater number of indoor units with the VRV IV Q Series

- Increase in capacity is possible while using existing piping.
- More indoor units can be connected in a single system, enabling consolidation of existing piping.

An automatic refrigerant charge function enables high quality installation for the VRV IV Q Series.

- The system is automatically charged with the proper amount of refrigerant even when the length of the existing piping is unknown.
- Equipment automatically performs a sequence of tasks from refrigerant charging to test operation.

Quick, Quality and Economical

Reuse

Simple use of existing refrigerant piping.

In the past, special equipment and work was needed to clean pipes when using existing piping, but this is no longer required. A new function automatically deals with contamination inside piping during refrigerant charging, eliminating the work involved in cleaning.

Even applicable for non-DAIKIN systems! The Daikin low-cost upgrade solution

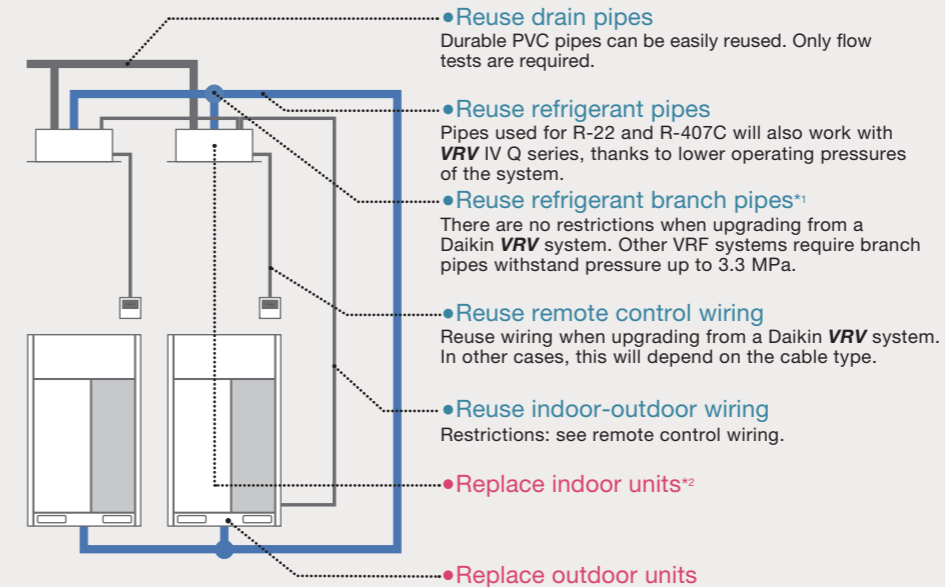

*1 For reuse of existing refrigerant piping, it is possible to use piping or branched piping capable of handling 3.3 MPa or more (In case of using Φ 41.3 pipe, the design pressure must be 3.1 MPa or more). Heat insulation is necessary for liquid piping and gas piping. Even if the existing liquid piping is not insulated, the piping can be reused by its field setting. Refer to the installation manual for details for the field setting.

**2 It is not possible to combine old R-22 and new R-410A indoor units in one system due to incompatibility of communication. It is not possible to keep R-407C indoor units.

Automatic

Refrigerant charging, cleaning and test operation done with just a single switch.

The unique automatic refrigerant charge eliminates the need to calculate refrigerant volume, simplifying the installation process. Not knowing the exact piping lengths because of changes or mistakes in case you didn't do the original installation or replacing a competitor installation no longer poses a problem. Furthermore, there is no need to clean inside piping as this is handled automatically by the VRV IV Q unit.

* There are conditions in the range (ambient temperature, connection ratio) in which the automatic refrigerant charge can be used. Refer to the installation manual for details. The refrigerant amount that can be automatically charged may differ from the additional refrigerant amount that is provided from calculations, but there are no problems in performance and quality.

Time saving

Enables smooth replacement of air conditioning with less effect on operations and users in the building.

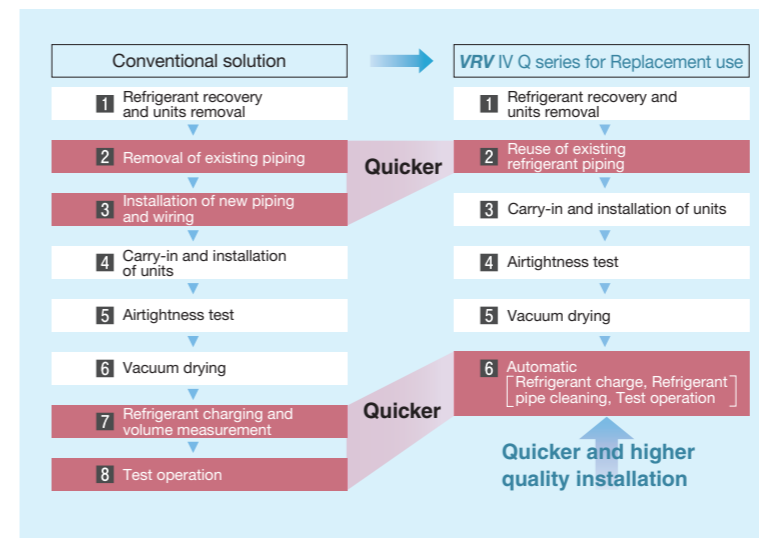

Cost saving

Work costs for pipe removal, installation and insulation account for much of the total cost. By the reuse of existing piping, 35% of cost down can be realized compared to installing new pipes.

■ Cost details (10 class example)
*Estimated in Japan by Daikin.

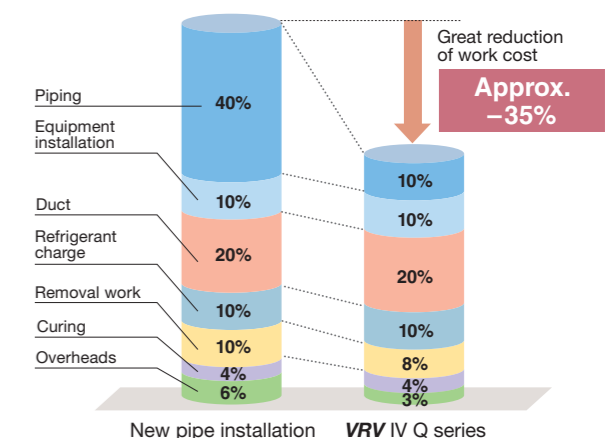

Design flexibility

Significantly more compact outdoor unit enables the effective use of limited space!

Compact design enables the effective use of space taken up by existing machinery

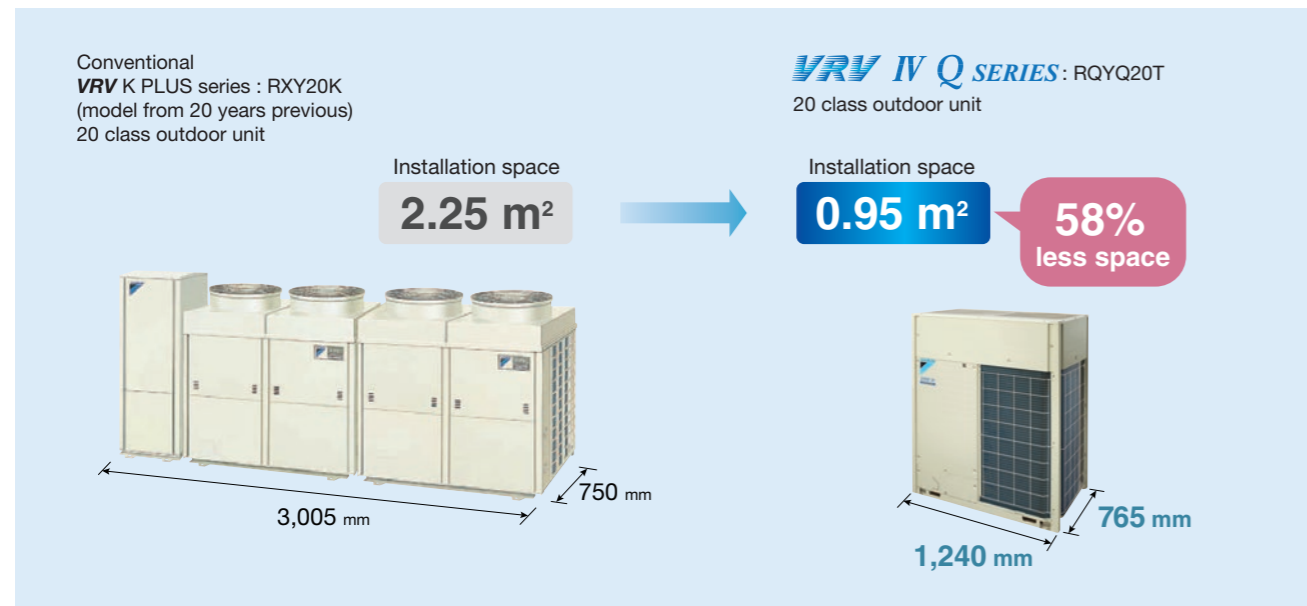

High external static pressure 78.4 Pa

Conventional **VRV K series** (model from 20 years previous)

49.0 Pa

VRV IV Q SERIES

78.4 Pa

External static pressure
78.4 Pa

Easier discharge hood connection (field setting)

Easy installation on each floor for use in tall buildings

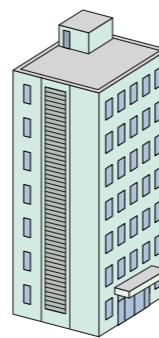

Small and light, significantly reducing constraints during carry-in



Can be carried on a cart



Can be transported easily by elevator

System flexibility

An increased number of connectable indoor units in a single system

More indoor units can be connected in a single system, enabling consolidation of existing piping!

The number of connectable indoor units has been drastically increased from 30 to 64.

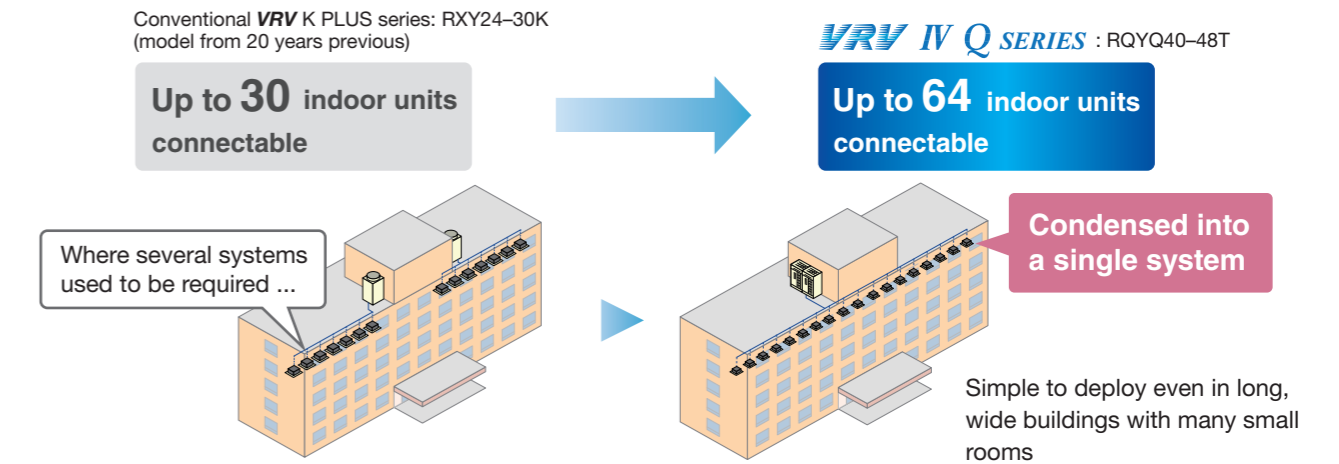

Enables increased capacity

System can be upgraded using existing piping

VRV IV Q series for replacement use enables the system capacity to be increased without changing the refrigerant piping. For example, it is possible to install a 16 class **VRV IV Q series** using the refrigerant piping of an 10 class R-22 system.

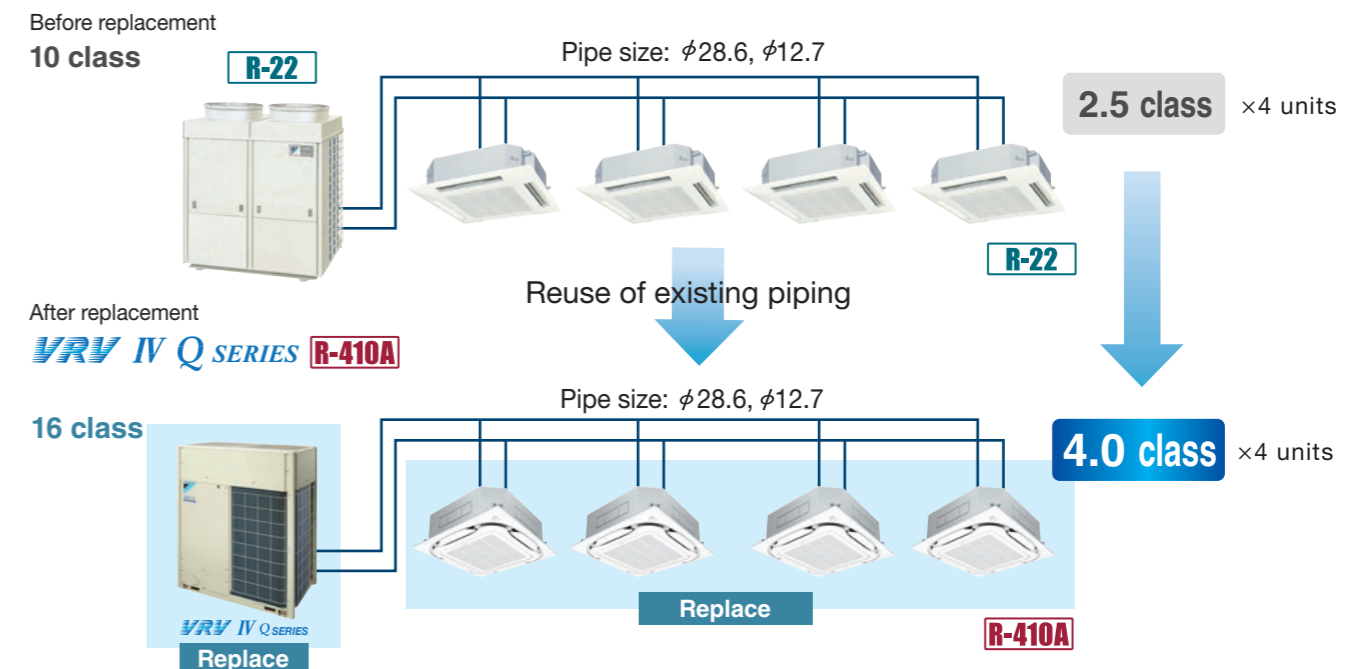

* For reuse of existing refrigerant piping, it is possible to use piping or branched piping capable of handling 3.3 MPa or more (In case of using $\phi 41.3$ pipe, the design pressure must be 3.1 MPa or more). Heat insulation is necessary for liquid piping and gas piping. Even if the existing liquid piping is not insulated, the piping can be reused by its field setting. Refer to the installation manual for details for the field setting.

Enhanced lineup

2 types up to 48 class

With its enhanced lineup of 2 types and Standard and Space saving types, **VRV IV Q** series outdoor units offer a high capacity up to 48 class to meet an ever wider variety of needs.

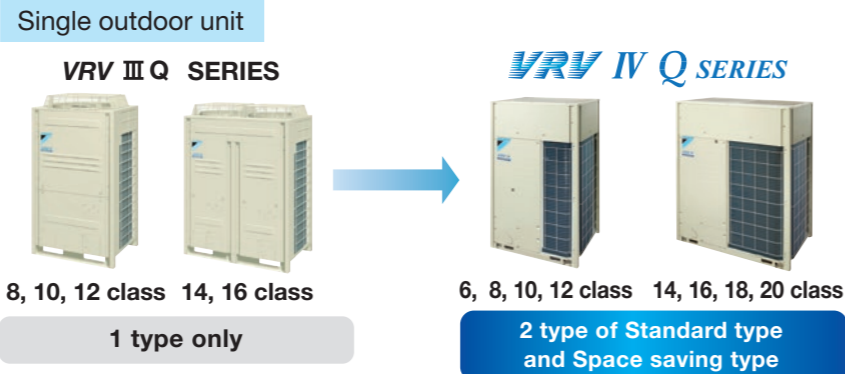

Lineup

class	6	8	10	12	14	16	18	20	22	24	26	28	30	32	34	36	38	40	42	44	46	48	
Standard Type	●	●	●	●	●	●	●	●	●	●	●	●	●	●	●	●	●	●	●	●	●	●	●
Space Saving Type							●	●					●	●	●	●	●	●	●	●	●	●	●

Compact & light weight design

New Space Saving type with refined design

As a leading global innovator, Daikin advanced from the conventional 2 module combination to a single module for 18 and 20 class models. This allows the installation area to reduce by 33% as compared to the previous models.



Energy saving

Higher Coefficient of Performance (COP)

COP at 100% operation load

VRV IV Q series delivers highly efficient performance, contributing to high energy savings.

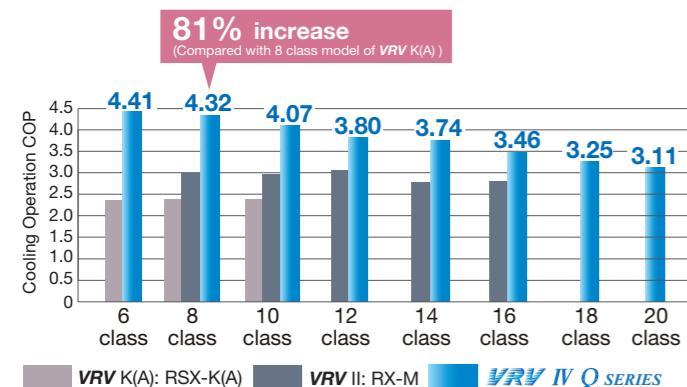

COP for 10 class

Improved efficiency during long operation under low load

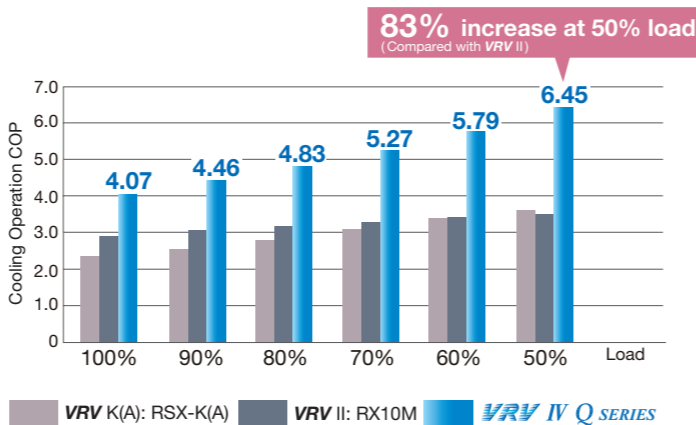

*Cooling operation conditions: Indoor temp. of 27°CDB, 19°CWB, and outdoor temp. of 35°CDB.

State-of-the-art energy saving technology for VRV system

Customise your VRV system for optimal annual efficiency

The new **VRV IV Q** series now features VRT technology. VRT automatically adjusts refrigerant temperature to individual building and climate requirement, thus further improving annual energy efficiency and maintaining comfort. With this excellent technology, running costs are reduced.



How is energy reduced?

During cooling, the refrigerant evaporating temperature (T_e) is raised to minimise the difference with the condensing temperature. During heating, condensing temperature (T_c) is lowered to minimise the difference to the evaporating temperature. Compressors work less, and this reduces power consumption.

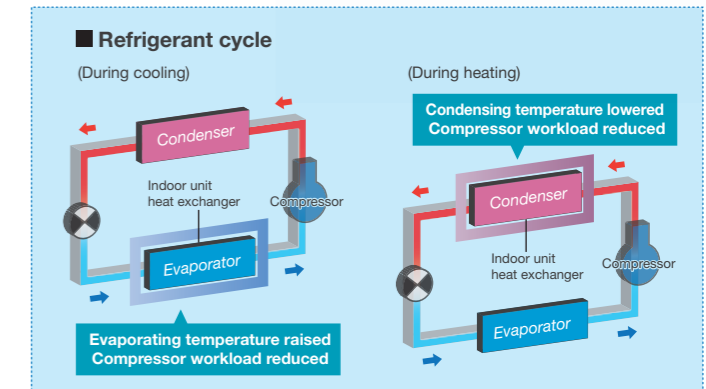

Typical changes in evaporating temperature and COP depending on changing indoor load

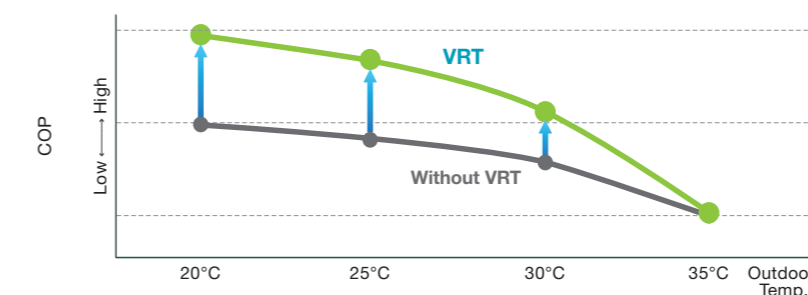
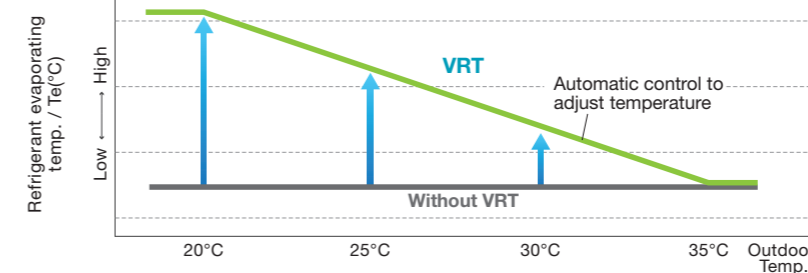
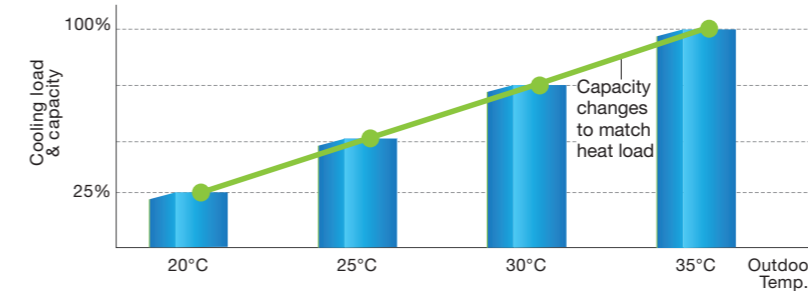

Required capacity changes as air conditioning load changes according to outdoor temperature.

In case of fixed evaporating temperature, excessive cooling, thermo on-off loss, and other inefficiencies occur.

Automatic control adjusts evaporating temperature to heat load change.

Energy efficiency is improved without sacrificing comfort.

New technology that enables use of existing piping

New tested contamination collection method

A new method collects contamination from existing piping, eliminating compressors and electric valves malfunction.



Acid

An acid neutraliser agent is added to disable acids (chlorine ions), which cause corrosion.

Labels: Acid (chlorine ion), Acid neutraliser, Refrigerant pipe.

Impurities

A generously sized filter is provided inside the refrigerant circuit which traps impurities.

Labels: Refrigerant flow, Filter, Impurities, Iron powder, etc.

Iron powder

A magnet is installed inside the accumulator where liquid refrigerant accumulates. The magnet attracts iron powder to keep the system clean.

Labels: Iron powder, Accumulator, Magnet, To compressor.

Outer Rotor DC Motor (ODM)

Only Daikin adapted ODM with feature of stable rotation and volumetric efficiency

Advantages of ODM

Thanks to large diameter of the rotor,

- ① Large torque with same electromagnetic force
- ② Stable rotation in all range, and can be operated with small number of rotations



Conventional Motor (Inner Type)

Labels: Rotor, F.

ODM (Outer Type)

Labels: Rotor, F.



HIGH TORQUE with low energy → **MORE efficient**

Highly integrated heat exchanger

Improve performance by increasing heat exchanger area while maintaining the same installation space.

VRV III Q series

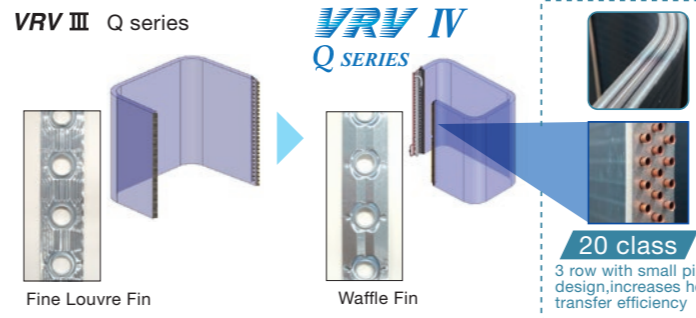

Realise highly integrated heat exchanger performance (increase row, reduce fin pitch) by reducing of airflow resistance which changes cooling tube to $\varnothing 7$.

Change fin shape from fine louvre to waffle fin. Fin pitch can be reduced fin pitch from 2.0 mm to 1.4 mm, to realise unit efficiency which increased heat exchanger area.

Advanced control main PC board

SMT* packaging technology

- SMT packaging technology adopted by the whole computer control panel improves the anti-clutter performance.
- Protects your computer boards from the adverse effect of sandy and humid weather.

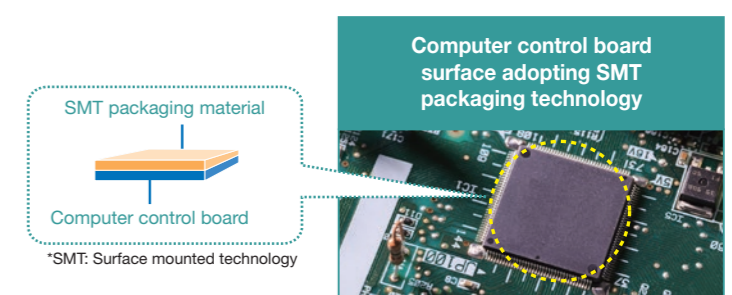

Computer control board surface adopting SMT packaging technology

Refrigerant cooling technology, ensures stability of PCB temperature

Improved inner design to increase smooth airflow

Downsize electric component, re-locate to dead space of bell mouth side to decrease airflow resistance.

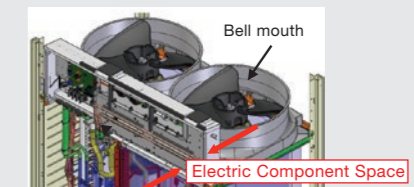

VRV III Q series



VRV IV Q SERIES

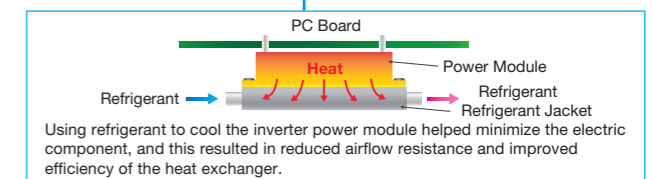
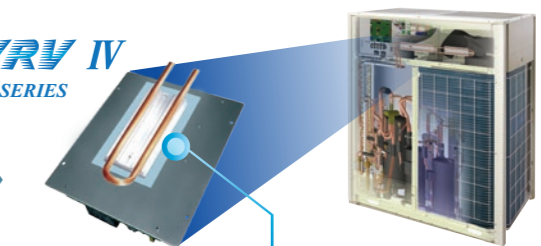

Roof terrace temperature in summer is over 40°C, seriously affecting inverter cooling efficiency, resulting in decline of inverter operating speed. Finally device parts response speed is reduced.

Control board failure ratio at stable operation is reduced.

Improve reliability at high ambient temperature

It is possible to cool the inverter power module stability even at high ambient temperature. This helps to keep air-conditioning capacity and also reduces failure ratio.

VRV IV Q SERIES Heat Pump

Piping limits for reuse of existing piping

VRV IV Q Series Heat Pump

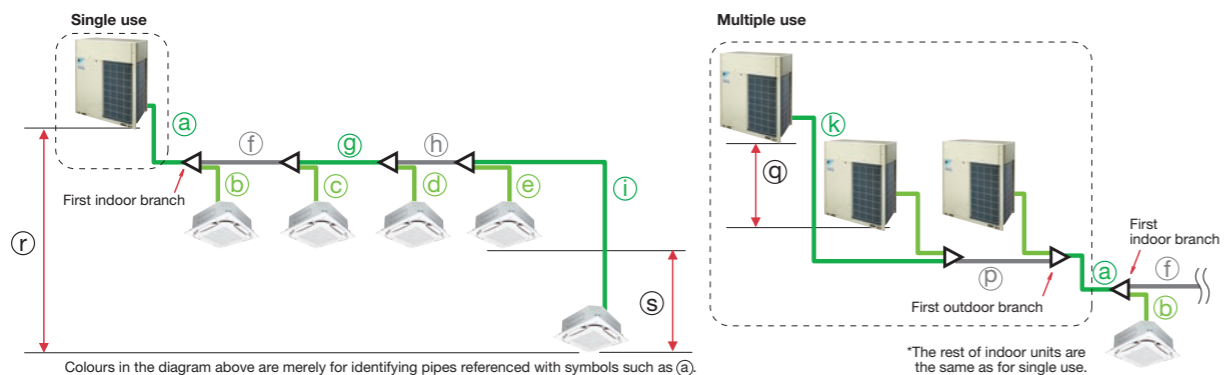

Maximum allowable piping length	Refrigerant piping length		Actual piping length	Example	Equivalent piping length
		Total piping length		150 m	a+f+g+h+i
	Between the first indoor branch and the farthest indoor unit		300 m	a+b+c+d+e+f+g+h+i	—
	Between the outdoor branch and the last outdoor unit		40 m	f+g+h+i	—
	Between the outdoor branch and the last outdoor unit		10 m	k+p	13 m
Maximum allowable level difference	Level Difference		Example		
	Between the outdoor units (Multiple use)		5 m	q	
	Between the indoor units		15 m	s	
	Between the outdoor units and the indoor units		If the outdoor unit is above. 50 m If the outdoor unit is below. 40 m	r	

VRV III Q Series Heat Recovery

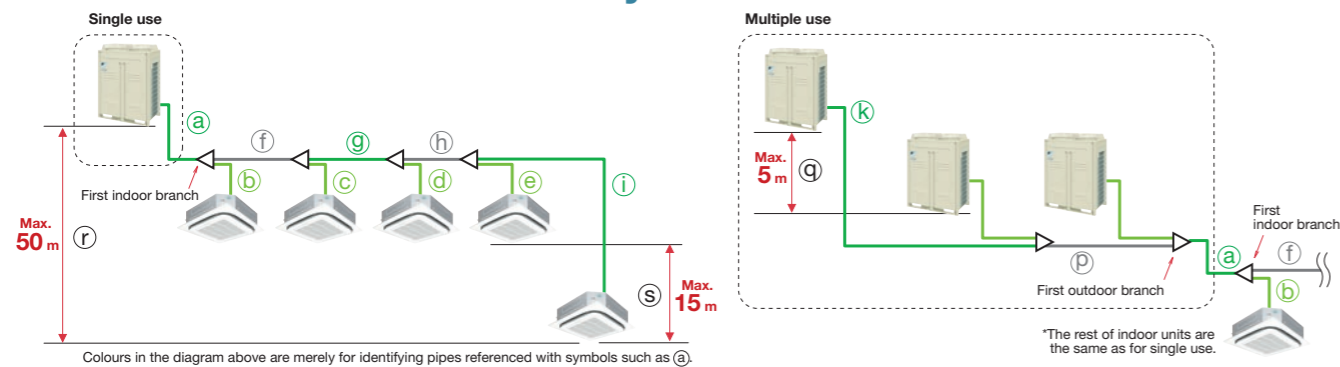

Maximum allowable piping length	Refrigerant piping length		Actual piping length	Example	Equivalent piping length
		RQYQ8-48P		150 m	a+f+g+h+i
	RQYQ140P, RQCEQ-P		120 m	a+b+c+d+e+f+g+h+i	150 m
	Total piping length		300 m	a+b+c+d+e+f+g+h+i	—
	Between the first indoor branch and the farthest indoor unit		40 m	f+g+h+i	—
	Between the outdoor branch and the last outdoor unit		10 m	k+p	13 m
Maximum allowable level difference	Level Difference		Example		
	Between the outdoor units (Multiple use)		5 m	q	
	Between the indoor units		15 m	s	
	Between the outdoor units and the indoor units		If the outdoor unit is above. 50 m If the outdoor unit is below. 40 m	r	

Reusability of existing piping

VRV IV Q Series Heat Pump

Type of piping	Capacity	Piping size															
		Liquid								Gas							
		φ6.4	φ9.5	φ12.7	φ15.9	φ19.1	φ22.2	φ25.4	φ28.6	φ31.8	φ34.9	φ38.1	φ41.3	φ44.5	φ47.7	φ50.9	
Main piping	6 class	x	S	●	●	●	●	●	●	●	●	●	●	●	●	●	
	8 class	x	S	●	●	●	●	●	●	●	●	●	●	●	●	●	
	10 class	x	S	●	●	●	●	●	●	●	●	●	●	●	●	●	
	12 class	x	x	S	●	●	●	●	●	●	●	●	●	●	●	●	
	14 class	x	x	S	●	●	●	●	●	●	●	●	●	●	●	●	
	16 class	x	x	S	●	●	●	●	●	●	●	●	●	●	●	●	
	18 class	x	x	x	S	●	●	●	●	●	●	●	●	●	●	●	
	20 class	x	x	x	S	●	●	●	●	●	●	●	●	●	●	●	
	22 class	x	x	x	S	●	●	●	●	●	●	●	●	●	●	●	
	24 class	x	x	x	S	●	●	●	●	●	●	●	●	●	●	●	
	26 class	x	x	x	x	S	●	●	●	●	●	●	●	●	●	●	
	28 class	x	x	x	x	S	●	●	●	●	●	●	●	●	●	●	
	30 class	x	x	x	x	S	●	●	●	●	●	●	●	●	●	●	
	32 class	x	x	x	x	S	●	●	●	●	●	●	●	●	●	●	
	34 class	x	x	x	x	S	●	●	●	●	●	●	●	●	●	●	
	36 class	x	x	x	x	S	●	●	●	●	●	●	●	●	●	●	
38 class	x	x	x	x	S	●	●	●	●	●	●	●	●	●	●		
40 class	x	x	x	x	S	●	●	●	●	●	●	●	●	●	●		
42 class	x	x	x	x	S	●	●	●	●	●	●	●	●	●	●		
44 class	x	x	x	x	S	●	●	●	●	●	●	●	●	●	●		
46 class	x	x	x	x	S	●	●	●	●	●	●	●	●	●	●		
48 class	x	x	x	x	S	●	●	●	●	●	●	●	●	●	●		
From REFNET to REFNET ¹	< 100	x	S	●	●	●	●	●	●	●	●	●	●	●	●	●	
	100 ≤ X < 150	x	S	●	●	●	●	●	●	●	●	●	●	●	●	●	
	150 ≤ X < 160	x	S	●	●	●	●	●	●	●	●	●	●	●	●	●	
	160 ≤ X < 200	x	S	●	●	●	●	●	●	●	●	●	●	●	●	●	
	200 ≤ X < 290	x	S	●	●	●	●	●	●	●	●	●	●	●	●	●	
	290 ≤ X < 330	x	x	S	●	●	●	●	●	●	●	●	●	●	●	●	
	330 ≤ X < 420	x	x	S	●	●	●	●	●	●	●	●	●	●	●	●	
	420 ≤ X < 480	x	x	x	S	●	●	●	●	●	●	●	●	●	●	●	
	480 ≤ X < 640	x	x	x	S	●	●	●	●	●	●	●	●	●	●	●	
	640 ≤ X < 900	x	x	x	x	S	●	●	●	●	●	●	●	●	●	●	
900 ≤ X < 920	x	x	x	x	S	●	●	●	●	●	●	●	●	●	●		
920 ≤	x	x	x	x	S	●	●	●	●	●	●	●	●	●	●		
From REFNET to indoor unit ²	20-40 class	S	●	●	●	●	●	●	●	●	●	●	●	●	●	●	
	50 class	S	●	●	●	●	●	●	●	●	●	●	●	●	●	●	
	63-80 class	x	S	●	●	●	●	●	●	●	●	●	●	●	●	●	
	100-125 class	x	S	●	●	●	●	●	●	●	●	●	●	●	●	●	
	140-145 class	x	S	●	●	●	●	●	●	●	●	●	●	●	●	●	
	180 class	x	S	●	●	●	●	●	●	●	●	●	●	●	●	●	
	200 class	x	S	●	●	●	●	●	●	●	●	●	●	●	●	●	
250 class	x	S	●	●	●	●	●	●	●	●	●	●	●	●	●		

● : Piping size of conventional R-22, R-407C model
 ○ : Piping size of conventional R-410A model
 S : Standard piping size of VRV IV Q series. However, when equivalent piping length between outdoor unit and indoor unit is 90 m or more, size of main piping must be increased.
 x : Not possible

¹ Piping between REFNETs depends on total capacity index of indoor units connected below each REFNET. It cannot exceed piping size of upstream side.
² Piping from REFNET to indoor unit depends on the capacity of the connected indoor unit. It cannot exceed piping size of upstream side.

VRV III Q Series Heat Recovery

Type of piping	class	Piping size															
		Liquid								High and low pressure gas							
		φ6.4	φ9.5	φ12.7	φ15.9	φ19.1	φ22.2	φ25.4	φ28.6	φ31.8	φ34.9	φ38.1	φ41.3	φ44.5	φ47.7	φ50.9	
Main piping	10 class	x	S	●	●	●	●	●	●	●	●	●	●	●	●	●	
	13 class	x	x	S	●	●	●	●	●	●	●	●	●	●	●	●	
	16 class	x	x	S	●	●	●	●	●	●	●	●	●	●	●	●	
	18 class	x	x	x	S	●	●	●	●	●	●	●	●	●	●	●	
	20 class	x	x	x	S	●	●	●	●	●	●	●	●	●	●	●	
	22 class	x	x	x	S	●	●	●	●	●	●	●	●	●	●	●	
	24 class	x	x	x	S	●	●	●	●	●	●	●	●	●	●	●	
	26 class	x	x	x	x	S	●	●	●	●	●	●	●	●	●	●	
	28 class	x	x	x	x	S	●	●	●	●	●	●	●	●	●	●	
	30 class	x	x	x	x	S	●	●	●	●	●	●	●	●	●	●	
From REFNET to REFNET ¹	< 50	S	●	●	●	●	●	●	●	●	●	●	●	●	●	●	
	50 ≤ X < 100	x	S	●	●	●	●	●	●	●	●	●	●	●	●	●	
	100 ≤ X < 150	x	S	●	●	●	●	●	●	●	●	●	●	●	●	●	
	150 ≤ X < 160	x	S	●	●	●	●	●	●	●	●	●	●	●	●	●	
	160 ≤ X < 200	x	S	●	●	●	●	●	●	●	●	●	●	●	●	●	
	200 ≤ X < 290	x	S	●	●	●	●	●	●	●	●	●	●	●	●	●	
	290 ≤ X < 330	x	x	S	●	●	●	●	●	●	●	●	●	●	●	●	
	330 ≤ X < 420	x	x	S	●	●	●	●	●	●	●	●	●	●	●	●	
	420 ≤ X < 480	x	x	x	S	●	●	●	●	●	●	●	●	●	●	●	
	480 ≤ X < 640	x	x	x	S	●	●	●	●	●	●	●	●	●	●	●	
640 ≤ X < 700	x	x	x	x	S	●	●	●	●	●	●	●	●	●	●		
700 ≤ X < 900	x	x	x	x	S	●	●	●	●	●	●	●	●	●	●		
900 ≤	x	x	x	x	S	●	●	●	●	●	●	●	●	●	●		
From BS to indoor unit ²	20-40 class	S	●	●	●	●	●	●	●	●	●	●	●	●	●	●	
	50 class	S	●	●	●	●	●	●	●	●	●	●	●	●	●	●	
	63 class	x	S	●	●	●	●	●	●	●	●	●	●	●	●	●	
	80 class	x	S	●	●	●	●	●	●	●	●	●	●	●	●	●	
	100-125 class	x	S	●	●	●	●	●	●	●	●	●	●	●	●	●	
	140-145 class	x	S	●	●	●	●	●	●	●	●	●	●	●	●	●	
	180 class	x	S	●	●	●	●	●	●	●	●	●	●	●	●	●	
200 class	x	S	●	●	●	●	●	●	●	●	●	●	●	●	●		
250 class	x	S	●	●	●	●	●	●	●	●	●	●	●	●	●		

● : Piping size of conventional R-22, R-407C model
 ○ : Piping size of conventional R-410A model
 S : Standard piping size of VRV III Q series. However, when equivalent piping length between outdoor unit and indoor unit is 90 m or more, size of main piping must be increased.
 x : Not possible

¹ Piping between REFNETs depends on total capacity index of indoor units connected below each REFNET. It cannot exceed piping size of upstream side.
² Piping from BS to indoor unit depends on the capacity of the connected indoor unit. It cannot exceed piping size of upstream side.

System lineup for replacement use

VRV IV Q Series Outdoor Units Heat Pump

Outdoor Unit Combinations

Standard Type

class	kW	Capacity index	Model name	Combination	Outdoor unit multi connection piping kit ^{*1}	Total capacity index of connectable indoor units ^{*3}	Maximum number of connectable indoor units ^{*2}
6	16.0	150	RQYQ6T	RQYQ6T	—	75 to 195	9
8	22.4	200	RQYQ8T	RQYQ8T	—	100 to 260	13
10	28.0	250	RQYQ10T	RQYQ10T	—	125 to 325	16
12	33.5	300	RQYQ12T	RQYQ12T	—	150 to 390	19
14	40.0	350	RQYQ14T	RQYQ14T	—	175 to 455	22
16	45.0	400	RQYQ16T	RQYQ16T	—	200 to 520	26
18	50.4	450	RQYQ18TN	RQYQ8T + RQYQ10T	BHFP22P100	225 to 585	29
20	55.9	500	RQYQ20TN	RQYQ8T + RQYQ12T		250 to 650	32
22	61.5	550	RQYQ22TN	RQYQ10T + RQYQ12T		275 to 715	35
24	67.0	600	RQYQ24TN	RQYQ12T × 2		300 to 780	39
26	73.5	650	RQYQ26TN	RQYQ12T + RQYQ14T		325 to 845	42
28	78.5	700	RQYQ28TN	RQYQ12T + RQYQ16T		350 to 910	45
30	85.0	750	RQYQ30TN	RQYQ14T + RQYQ16T		375 to 975	48
32	90.0	800	RQYQ32TN	RQYQ14T + RQYQ18T		400 to 1,040	52
34	95.0	850	RQYQ34TN	RQYQ10T + RQYQ12T × 2		425 to 1,105	55
36	101	900	RQYQ36TN	RQYQ12T × 3		450 to 1,170	58
38	106	950	RQYQ38TN	RQYQ8T + RQYQ12T + RQYQ18T	BHFP22P151	475 to 1,235	61
40	112	1,000	RQYQ40TN	RQYQ12T × 2 + RQYQ16T		500 to 1,300	64
42	119	1,050	RQYQ42TN	RQYQ12T + RQYQ14T + RQYQ16T		525 to 1,365	
44	124	1,100	RQYQ44TN	RQYQ12T + RQYQ16T × 2		550 to 1,430	
46	130	1,150	RQYQ46TN	RQYQ14T × 2 + RQYQ18T		575 to 1,495	
48	135	1,200	RQYQ48TN	RQYQ14T + RQYQ16T + RQYQ18T		600 to 1,560	

Note: ^{*1} For multiple connection of 18 class systems and above, the outdoor unit multi connection piping kit (separately sold) is required.
^{*2} Total capacity index of connectable indoor units must be 50%–130% of the capacity index of the outdoor units.
^{*3} When outdoor-air processing units and standard indoor units are connected, the total connection capacity index of the outdoor-air processing units must not exceed 30% of the capacity index of the outdoor units. And the connection ratio must not exceed 100%.

Space Saving Type

class	kW	Capacity index	Model name	Combination	Outdoor unit multi connection piping kit ^{*1}	Total capacity index of connectable indoor units ^{*3}	Maximum number of connectable indoor units ^{*2}
18	50.0	450	RQYQ18T	RQYQ18T	—	225 to 585	29
20	56.0	500	RQYQ20T	RQYQ20T	—	250 to 650	32
30	83.5	750	RQYQ30TS	RQYQ12T + RQYQ18T	BHFP22P100	375 to 975	48
32	89.5	800	RQYQ32TS	RQYQ12T + RQYQ20T		400 to 1,040	52
34	95.0	850	RQYQ34TS	RQYQ16T + RQYQ18T		425 to 1,105	55
36	100	900	RQYQ36TS	RQYQ18T × 2		450 to 1,170	58
38	106	950	RQYQ38TS	RQYQ18T + RQYQ20T		475 to 1,235	61
40	112	1,000	RQYQ40TS	RQYQ20T × 2		500 to 1,300	64
42	117	1,050	RQYQ42TS	RQYQ12T × 2 + RQYQ18T		525 to 1,365	
44	123	1,100	RQYQ44TS	RQYQ12T × 2 + RQYQ20T		550 to 1,430	
46	129	1,150	RQYQ46TS	RQYQ12T + RQYQ16T + RQYQ18T		575 to 1,495	
48	134	1,200	RQYQ48TS	RQYQ12T + RQYQ18T × 2		600 to 1,560	

Note: ^{*1} For multiple connection of 30 class and above the outdoor unit multi connection piping kit (separately sold) is required.
^{*2} Total capacity index of connectable indoor units must be 50%–130% of the capacity index of the outdoor units.
^{*3} When outdoor-air processing units and standard indoor units are connected, the total connection capacity index of the outdoor-air processing units must not exceed 30% of the capacity index of the outdoor units. And the connection ratio must not exceed 100%.

Standard Type

•Single Outdoor Units

6, 8, 10, 12 class



RQYQ6TY1A(E)
RQYQ8TY1A(E)
RQYQ10TY1A(E)
RQYQ12TY1A(E)

14, 16 class



RQYQ14TY1A(E)
RQYQ16TY1A(E)

•Double Outdoor Units

18, 20, 22, 24 class



RQYQ18TNY1A(E)
RQYQ20TNY1A(E)
RQYQ22TNY1A(E)
RQYQ24TNY1A(E)

26, 28 class



RQYQ26TNY1A(E)
RQYQ28TNY1A(E)

30, 32 class



RQYQ30TNY1A(E)
RQYQ32TNY1A(E)

•Triple Outdoor Units

34, 36 class



RQYQ34TNY1A(E)
RQYQ36TNY1A(E)

38, 40 class



RQYQ38TNY1A(E)
RQYQ40TNY1A(E)

42, 44 class



RQYQ42TNY1A(E)
RQYQ44TNY1A(E)

46, 48 class



RQYQ46TNY1A(E)
RQYQ48TNY1A(E)

Space Saving Type

•Single Outdoor Units

18, 20 class



RQYQ18TY1A(E)
RQYQ20TY1A(E)

•Double Outdoor Units

30, 32 class



RQYQ30TSY1A(E)
RQYQ32TSY1A(E)

34, 36, 38, 40 class



RQYQ34TSY1A(E)
RQYQ36TSY1A(E)
RQYQ38TSY1A(E)
RQYQ40TSY1A(E)

•Triple Outdoor Units

42, 44 class



RQYQ42TSY1A(E)
RQYQ44TSY1A(E)

46, 48 class



RQYQ46TSY1A(E)
RQYQ48TSY1A(E)

Lineup

class	6	8	10	12	14	16	18	20	22	24	26	28	30	32	34	36	38	40	42	44	46	48	
Standard Type	●	●	●	●	●	●	●	●	●	●	●	●	●	●	●	●	●	●	●	●	●	●	●
Space Saving Type							●	●					●	●	●	●	●	●	●	●	●	●	●

System lineup for replacement use

VRV III Q Series Outdoor Units Heat Recovery

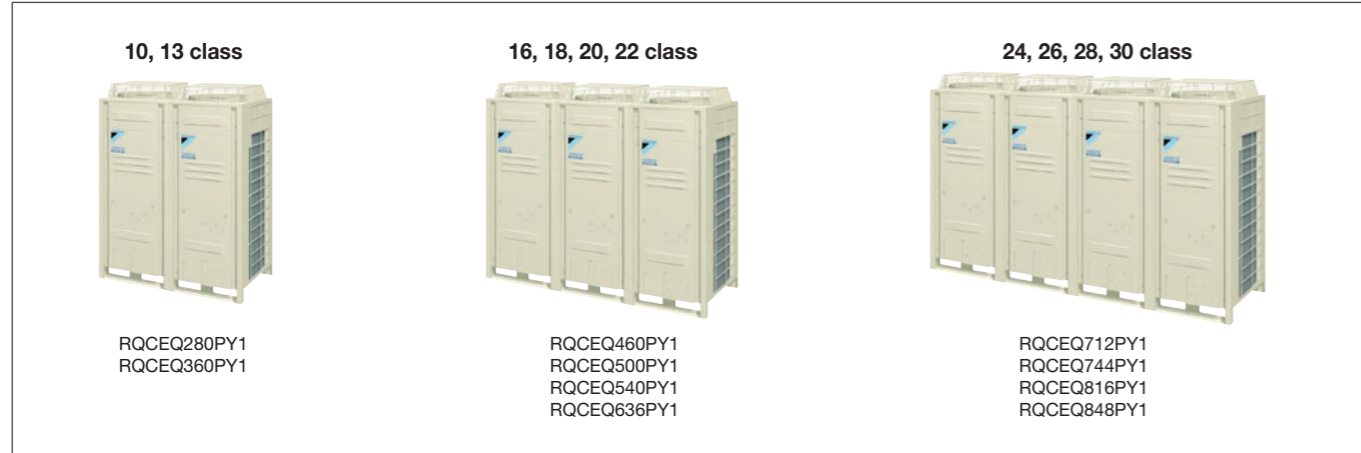

Outdoor Unit Combinations

class	kW	Capacity index	Model name	Combination	Outdoor unit multi connection piping kit ^{*1}	Total capacity index of connectable indoor units ^{*2 *3}			Maximum number of connectable indoor units
						Combination (%)			
						50%	100%	130%	
10	28.0	250	RQCEQ280P	RREQ140P+RREQ140P	BHFP26P36C	125	250	325	16
13	36.0	325	RQCEQ360P	RREQ180P+RREQ180P		162.5	325	422.5	21
16	46.0	400	RQCEQ460P	RREQ140P+RREQ140P+RREQ180P	BHFP26P63C	200	400	520	26
18	50.0	450	RQCEQ500P	RREQ140P+RREQ180P+RREQ180P		225	450	585	29
20	54.0	500	RQCEQ540P	RREQ180P+RREQ180P+RREQ180P		250	500	650	32
22	63.6	550	RQCEQ636P	RREQ212P+RREQ212P+RREQ212P		275	550	715	35
24	71.2	600	RQCEQ712P	RREQ140P+RREQ180P+RREQ180P+RREQ212P	BHFP26P84C	300	600	780	39
26	74.4	650	RQCEQ744P	RREQ140P+RREQ180P+RREQ212P+RREQ212P		325	650	845	42
28	81.6	700	RQCEQ816P	RREQ180P+RREQ212P+RREQ212P+RREQ212P		350	700	910	45
30	84.8	750	RQCEQ848P	RREQ212P+RREQ212P+RREQ212P+RREQ212P		375	750	975	48

*1 The outdoor unit multi connection piping kit (separately sold) is required for multiple connections.
 *2 Total capacity index of connectable indoor units must be 50%~130% of the capacity index of the outdoor units.
 *3 For indoor units used for cooling only (do not connect to BS unit when using for heat recovery), total capacity index must be 50% or less than the capacity index of the outdoor units.
 *4 When outdoor-air processing units and standard indoor units are connected, the total connection capacity index of the outdoor-air processing units must not exceed 30% of the capacity index of the outdoor units. And the connection ratio must not exceed 100%.

Variety of Indoor Unit

Type	Model Name	Capacity Range(kW)	Capacity Index																			
			2.2	2.8	3.6	4.5	5.6	7.1	8	9	11.2	14	16	16.2	18	20	22.4	28				
			20	25	31.25	40	50	62.5	71	80	100	125	140	145	160	180	200	250				
Ceiling Mounted Cassette (Round Flow with Sensing)	FXFSQ-AVM			●	●	●	●	●			●	●	●									
Ceiling Mounted Cassette (Round Flow)	FXFQ-PVE			●	●	●	●	●			●	●	●									
Ceiling Mounted Cassette (Compact Multi Flow)	FXZQ-A2VEB		●	●	●	●	●															
4-Way Flow Ceiling Suspended	FXUQ-AVEB								●		●											
Ceiling Mounted Cassette (Double Flow)	New FXCQ-AVM		●	●	●	●	●	●			●		●									
Ceiling Mounted Cassette (Single Flow)	FXEQ-AV36		●	●	●	●	●	●														
Slim Ceiling Mounted Duct (Compact Series)	FXDQ-TV1B(A)		●	●	●	●	●	●														
Slim Ceiling Mounted Duct (Standard Series)	FXDQ-PDVE		●	●	●																	
	FXDQ-NDVE				●	●	●															
Ceiling Concealed Duct	FXDYQ-MAV1										●	●	●	●								
Middle Static Pressure Ceiling Mounted Duct	FXSQ-PAVE		●	●	●	●	●	●			●	●	●	●								
Ceiling Mounted Duct	FXMQ-PAVE		●	●	●	●	●	●			●	●	●	●								
	FXMQ-PV1A														●	●	●	●				
Outdoor-Air Processing Unit	FXMQ-MFV1													●				●	●			
Ceiling Suspended	FXHQ-MAVE				●			●			●											
	New FXHQ-AVM														●	●						
Wall Mounted	New FXAQ-AVM		●	●	●	●	●	●														
Floor Standing	FXLQ-MAVE		●	●	●	●	●	●														
Concealed Floor Standing	FXNQ-MAVE		●	●	●	●	●	●														
Heat Reclaim Ventilator with DX-Coil and Humidifier	VKM-GA(M)V1		Airflow rate 500-1000 m³/h																			
Heat Reclaim Ventilator	VAM-GJVE		Airflow rate 150-2000 m³/h																			

* It is not possible to combine old R-22 and new R-410A indoor units in one system due to incompatibility of communication. It is not possible to keep R-407C indoor units.

VRV IV Q Series Outdoor Units Heat Pump **RQYQ-T**

Standard Type

MODEL		Combination units		RQYQ6TY1A(E)		RQYQ8TY1A(E)		RQYQ10TY1A(E)		RQYQ12TY1A(E)		RQYQ14TY1A(E)		RQYQ16TY1A(E)		RQYQ18TY1A(E)		RQYQ20TY1A(E)		RQYQ22TY1A(E)		RQYQ24TY1A(E)		RQYQ26TY1A(E)		RQYQ28TY1A(E)		RQYQ30TY1A(E)		RQYQ32TY1A(E)		
Power supply				3-phase 4-wire system, 380-415 V, 50 Hz												3-phase 4-wire system, 380-415 V, 50 Hz																
Cooling capacity		Btu/h		54,600	76,400	95,500	114,000	136,000	154,000									172,000	191,000	210,000	229,000	251,000	268,000	290,000	307,000							
		kW		16.0	22.4	28.0	33.5	40.0	45.0									50.4	55.9	61.5	67.0	73.5	78.5	85.0	90.0							
Heating capacity		Btu/h		61,400	85,300	107,000	128,000	154,000	171,000									193,000	213,000	235,000	256,000	281,000	299,000	324,000	345,000							
		kW		18.0	25.0	31.5	37.5	45.0	50.0									56.5	62.5	69.0	75.0	82.5	87.5	95.0	101							
Power consumption		Cooling	kW	3.63	5.21	7.29	9.01	10.9	13.0									12.5	14.2	16.3	18.0	19.9	22.0	23.9	26.3							
		Heating	kW	3.99	5.69	7.29	9.06	11.1	12.8									13.0	14.8	16.4	18.1	20.2	21.9	23.9	26.2							
Capacity control		%		20-100		16-100		15-100		11-100		10-100		8-100						6-100		5-100										
Casing colour		Ivory white (5Y7.5/1)																														
Compressor		Type	Hermetically Sealed Scroll Type																													
		Motor output	kW	2.4X1	3.4X1	4.1X1	5.2X1	(2.9X1)+(3.3X1)	(3.6X1)+(3.7X1)									(3.4X1)+(4.1X1)	(3.4X1)+(5.2X1)	(4.1X1)+(5.2X1)	(5.2X1)+(5.2X1)	(5.2X1)+(2.9X1)+(3.3X1)	(5.2X1)+(3.6X1)+(3.7X1)	(2.9X1)+(3.3X1)+(3.6X1)+(3.7X1)	(2.9X1)+(3.3X1)+(4.4X1)+(4.0X1)							
Airflow rate		ℓ/s		1,983	2,616	2,749	2,966	3,883										2,616+2,749	2,616+2,966	2,749+2,966	2,966+2,966	2,966+3,883		3,883+3,883								
		m ³ /min		119	157	165	178	233										157+165	157+178	165+178	178+178	178+233		233+233								
Dimensions (HXWXD)		mm		1,657X930X765				1,657X1,240X765				(1,657X930X765)+(1,657X930X765)				(1,657X930X765)+(1,657X1,240X765)				(1,657X1,240X765)+(1,657X1,240X765)												
Machine weight		kg		185		195		285		185+195		195+195		195+285		285+300																
Sound level		dB(A)		55	56	57	59	60	61	60	61	62	63	64																		
Sound power		dB(A)		75	76	78	79	80	83	80	81	82	83	85																		
Operation range		Cooling	°CDB	-5 to 49												-5 to 49																
		Heating	°CWB	-20 to 15.5												-20 to 15.5																
Refrigerant		Type	R-410A																													
		Charge	kg	5.9		6.0		6.3		10.3		10.4		5.9+6.0		5.9+6.3		6.0+6.3		6.3+6.3		6.3+10.3		6.3+10.4		10.3+10.4		10.3+11.7				
Piping connections		Liquid	mm	φ 9.5 (Brazing)				φ 12.7 (Brazing)				φ 15.9 (Brazing)				φ 19.1 (Brazing)																
		Gas	mm	φ 19.1 (Brazing)		φ 22.2 (Brazing)		φ 28.6 (Brazing)		φ 28.6 (Brazing)		φ 34.9 (Brazing)		φ 34.9 (Brazing)																		

MODEL		Combination units		RQYQ34TNY1A(E)		RQYQ36TNY1A(E)		RQYQ38TNY1A(E)		RQYQ40TNY1A(E)		RQYQ42TNY1A(E)		RQYQ44TNY1A(E)		RQYQ46TNY1A(E)		RQYQ48TNY1A(E)	
Power supply				3-phase 4-wire system, 380-415 V, 50 Hz												3-phase 4-wire system, 380-415 V, 50 Hz			
Cooling capacity		Btu/h		324,000	345,000	362,000	382,000	406,000	423,000									444,000	461,000
		kW		95.0	101	106	112	119	124									130	135
Heating capacity		Btu/h		365,000	386,000	406,000	427,000	454,000	471,000									498,000	515,000
		kW		107	113	119	125	133	138									146	151
Power consumption		Cooling	kW	25.3	27.0	29.6	31.0	32.9	35.0									37.2	39.3
		Heating	kW	25.4	27.2	29.9	30.9	33.0	34.7									37.3	39.0
Capacity control		%		5-100				4-100				3-100							
Casing colour		Ivory white (5Y7.5/1)																	
Compressor		Type	Hermetically Sealed Scroll Type																
		Motor output	kW	(4.1X1)+(5.2X1)+(5.2X1)	(5.2X1)+(5.2X1)+(5.2X1)	(3.4X1)+(5.2X1)+(4.4X1)+(4.0X1)	(5.2X1)+(5.2X1)+(3.6X1)+(3.7X1)	(5.2X1)+(2.9X1)+(3.3X1)+(3.6X1)+(3.7X1)	(5.2X1)+(3.6X1)+(3.7X1)+(3.6X1)+(3.7X1)									(2.9X1)+(3.3X1)+(2.9X1)+(3.3X1)+(4.4X1)+(4.0X1)	(2.9X1)+(3.3X1)+(3.6X1)+(3.7X1)+(4.4X1)+(4.0X1)
Airflow rate		ℓ/s		2,749+2,966+2,966	2,966+2,966+2,966	2,616+2,966+3,883	2,966+2,966+3,883	2,966+3,883+3,883										3,883+3,883+3,883	
		m ³ /min		165+178+178	178+178+178	157+178+233	178+178+233	178+233+233										233+233+233	
Dimensions (HXWXD)		mm		(1,657X930X765)+(1,657X930X765)		(1,657X930X765)+(1,657X930X765)		(1,657X930X765)+(1,657X1,240X765)		(1,657X930X765)+(1,657X1,240X765)		(1,657X1,240X765)+(1,657X1,240X765)		(1,657X1,240X765)+(1,657X1,240X765)		(1,657X1,240X765)+(1,657X1,240X765)			
Machine weight		kg		195+195+195		185+195+300		195+195+285		195+285+285		285+285+300							
Sound level		dB(A)		63	64	64	65	65	66										
Sound power		dB(A)		83	84	86	87	87	87										
Operation range		Cooling	°CDB	-5 to 49												-5 to 49			
		Heating	°CWB	-20 to 15.5												-20 to 15.5			
Refrigerant		Type	R-410A																
		Charge	kg	6.0+6.3+6.3		6.3+6.3+6.3		5.9+6.3+11.7		6.3+6.3+10.4		6.3+10.3+10.4		6.3+10.4+10.4		10.3+10.3+11.7		10.3+10.4+11.7	
Piping connections		Liquid	mm	φ 19.1 (Brazing)															
		Gas	mm	φ 34.9 (Brazing)				φ 41.3 (Brazing)				φ 41.3 (Brazing)				φ 41.3 (Brazing)			

Note: 1. Models with (E) are the outdoor units with anti-corrosion specifications. Please refer to Engineering Data Book for details.
 2. Specifications are based on the following conditions:
 •Cooling: Indoor temp.: 27°CDB, 19°CWB, Outdoor temp.: 35°CDB, Equivalent piping length: 7.5 m, Level difference: 0 m.
 •Heating: Indoor temp.: 20°CDB, Outdoor temp.: 7°CDB, 6°CWB, Equivalent piping length: 7.5 m, Level difference: 0 m.
 •Sound level: Anechoic chamber conversion value, measured at a point 1 m in front of the unit at a height of 1.5 m.
 During actual operation, these values are normally somewhat higher as a result of ambient conditions and oil recovery mode.
 When there is concern for noise the surrounding area such as residences, we recommend investigating the installation location and taking soundproofing measures.

VRV IV Q SERIES Heat Pump

VRV IV Q Series Outdoor Units Heat Pump RQYQ-T

Space Saving Type

MODEL		Combination units	RQYQ18TY1A(E)	RQYQ20TY1A(E)	RQYQ30TSY1A(E)	RQYQ32TSY1A(E)	RQYQ34TSY1A(E)	RQYQ36TSY1A(E)	RQYQ38TSY1A(E)	RQYQ40TSY1A(E)	RQYQ42TSY1A(E)	RQYQ44TSY1A(E)	RQYQ46TSY1A(E)	RQYQ48TSY1A(E)
Power supply			3-phase 4-wire system, 380-415 V, 50 Hz						3-phase 4-wire system, 380-415 V, 50 Hz					
Cooling capacity	Btu/h		171,000	191,000	285,000	305,000	324,000	341,000	362,000	382,000	399,000	420,000	440,000	457,000
	kW		50.0	56.0	83.5	89.5	95.0	100	106	112	117	123	129	134
Heating capacity	Btu/h		191,000	215,000	319,000	345,000	362,000	382,000	406,000	430,000	447,000	471,000	491,000	512,000
	kW		56.0	63.0	93.5	101	106	112	119	126	131	138	144	150
Power consumption	Cooling	kW	15.4	18.0	24.4	27.0	28.4	30.8	33.4	36.0	33.4	36.0	37.4	39.8
	Heating	kW	15.1	17.5	24.2	26.6	27.9	30.2	32.6	35.0	33.2	35.6	37.0	39.3
Capacity control	%		10-100	8-100	6-100		5-100				4-100			
Casing colour			Ivory white (5Y7.5/1)						Ivory white (5Y7.5/1)					
Compressor	Type		Hermetically Sealed Scroll Type						Hermetically Sealed Scroll Type					
	Motor output	kW	(4.4X1)+(4.0X1)	(4.6X1)+(5.5X1)	(5.2X1)+(4.4X1)+(4.0X1)	(5.2X1)+(4.6X1)+(5.5X1)	(3.6X1)+(3.7X1)+(4.4X1)+(4.0X1)	(4.4X1)+(4.0X1)+(4.4X1)+(4.0X1)	(4.4X1)+(4.0X1)+(4.6X1)+(5.5X1)	(4.6X1)+(5.5X1)+(4.6X1)+(5.5X1)	(5.2X1)+(5.2X1)+(4.4X1)+(4.0X1)	(5.2X1)+(5.2X1)+(4.6X1)+(5.5X1)	(5.2X1)+(3.6X1)+(3.7X1)+(4.4X1)+(4.0X1)	(5.2X1)+(4.4X1)+(4.0X1)+(4.4X1)+(4.0X1)
Airflow rate	l/s		3,883	4,466	2,966+3,883	2,966+4,466	3,883+3,883		3,883+4,466	4,466+4,466	2,966+2,966+3,883	2,966+2,966+4,466	2,966+3,883+3,883	
	m ³ /min		233	268	178+233	178+268	233+233		233+268	268+268	178+178+233	178+178+268	178+233+233	
Dimensions (HXWXD)	mm		1,657X1,240X765		(1,657X930X765)+(1,657X1,240X765)		(1,657X1,240X765)+(1,657X1,240X765)		(1,657X1,240X765)+(1,657X1,240X765)		(1,657X930X765)+(1,657X930X765)+(1,657X1,240X765)		(1,657X930X765)+(1,657X1,240X765)+(1,657X1,240X765)	
Machine weight	kg		300	320	195+300	195+320	285+300	300+300	300+320	320+320	195+195+300	195+195+320	195+285+300	195+300+300
Sound level	dB(A)		62	65	64	66	65		67	68	65	67	66	
Sound power	dB(A)		84	87	85	88	87		89	90	86	88	88	
Operation range	Cooling	°CDB	-5 to 49						-5 to 49					
	Heating	°CWB	-20 to 15.5						-20 to 15.5					
Refrigerant	Type		R-410A						R-410A					
	Charge	kg	11.7	11.8	6.3+11.7	6.3+11.8	10.4+11.7	11.7+11.7	11.7+11.8	11.8+11.8	6.3+6.3+11.7	6.3+6.3+11.8	6.3+10.4+11.7	6.3+11.7+11.7
Piping connections	Liquid	mm	φ 15.9(Brazing)		φ 19.1(Brazing)		φ 19.1(Brazing)		φ 19.1(Brazing)		φ 19.1(Brazing)		φ 19.1(Brazing)	
	Gas	mm	φ 28.6(Brazing)		φ 34.9(Brazing)		φ 41.3(Brazing)		φ 41.3(Brazing)		φ 41.3(Brazing)		φ 41.3(Brazing)	

Note: 1. Models with (E) are the outdoor units with anti-corrosion specifications. Please refer to Engineering Data Book for details.
2. Specifications are based on the following conditions:
•Cooling: Indoor temp.: 27°CDB, 19°CWB, Outdoor temp.: 35°CDB, Equivalent piping length: 7.5 m, Level difference: 0 m.
•Heating: Indoor temp.: 20°CDB, Outdoor temp.: 7°CDB, 6°CWB, Equivalent piping length: 7.5 m, Level difference: 0 m.

• Sound level: Anechoic chamber conversion value, measured at a point 1 m in front of the unit at a height of 1.5 m. During actual operation, these values are normally somewhat higher as a result of ambient conditions and oil recovery mode. When there is concern for noise the surrounding area such as residences, we recommend investigating the installation location and taking soundproofing measures.

VRV III Q Series Outdoor Units Heat Recovery RQCEQ-P

MODEL		Combination units	RQCEQ280PY1	RQCEQ360PY1	RQCEQ460PY1	RQCEQ500PY1	RQCEQ540PY1	RQCEQ636PY1	RQCEQ712PY1	RQCEQ744PY1	RQCEQ816PY1	RQCEQ848PY1		
Power supply			3-phase 4-wire system, 380-415 V, 50 Hz						3-phase 4-wire system, 380-415 V, 50 Hz					
Cooling capacity (*1) (*2)	Btu/h(*1)		96,200	124,000	158,000	172,000	186,000	218,000	245,000	256,000	280,000	291,000		
	kW(*1)		28.2	36.3	46.3	50.4	54.4	64.0	71.7	74.9	82.2	85.4		
Heating capacity	Btu/h		109,000	136,000	177,000	191,000	205,000	229,000	268,000	276,000	298,000	306,000		
	kW		32.0	40.0	52.0	56.0	60.0	67.2	78.4	80.8	87.2	89.6		
Power consumption	Cooling(*2)	kW	7.04	10.3	12.2	13.9	15.5	21.9	21.2	23.3	27.1	29.2		
	Heating	kW	8.00	10.7	13.4	14.7	16.1	17.7	20.7	21.2	23.1	23.6		
Capacity control	%		13-100	10-100	8-100		7-100			5-100				
Casing colour			Ivory white (5Y7.5/1)						Ivory white (5Y7.5/1)					
Compressor	Type		Hermetically sealed scroll type						Hermetically sealed scroll type					
	Motor output	kW	2.8X2	3.3X2	2.8X2+3.3	2.8+3.3X2	3.3X3	3.6X3	2.8+3.3X2+3.6	2.8+3.3+3.6X2	3.3+3.6X3	3.6X4		
Airflow rate	l/s		1583+1583	1833+1833	1583+1583+1833	1583+1833+1833	1833+1833+1833		1583+1833+1833+1833		1833+1833+1833+1833			
	m ³ /min		95+95	110+110	95+95+110	95+110+110	110+110+110		95+110+110+110		110+110+110+110			
Dimensions (HXWXD)	mm		(1,680X635X765)+(1,680X635X765)		(1,680X635X765)+(1,680X635X765)		(1,680X635X765)+(1,680X635X765)		(1,680X635X765)+(1,680X635X765)+(1,680X635X765)		(1,680X635X765)+(1,680X635X765)			
Machine weight	kg		175+175		175+175+175		179+179+179		175+175+175+179		175+179+179+179			
Sound level	dB(A)		57	61	61	62	63	65	64	65	66	66		
Operation range	Cooling	°CDB	-5 to 43						-5 to 43					
	Heating	°CWB	-20 to 15.5						-20 to 15.5					
	Cooling & Heating	°CWB	-6 to 15.5						-6 to 15.5					
Refrigerant	Type		R-410A						R-410A					
	Charge	kg	10.3+10.3	10.6+10.6	10.3+10.3+10.6	10.3+10.6+10.6	10.6+10.6+10.6	11.2+11.2+11.2	10.3+10.6+10.6+11.2	10.3+10.6+11.2+11.2	10.6+11.2+11.2+11.2	11.2+11.2+11.2+11.2		
Piping connections	Liquid	mm	φ 9.5 (Brazing)		φ 12.7 (Brazing)		φ 15.9 (Brazing)		φ 15.9 (Brazing)		φ 19.1 (Brazing)			
	Suction gas	mm	φ 22.2 (Brazing)		φ 25.4 (Brazing)		φ 28.6 (Brazing)		φ 28.6 (Brazing)		φ 34.9 (Brazing)			
	High and low pressure gas	mm	φ 19.1 (Brazing)		φ 19.1 (Brazing)		φ 22.2 (Brazing)		φ 25.4 (Brazing)		φ 28.6 (Brazing)			

Note: Specifications are based on the following conditions:
•Cooling(*1) Indoor temp.: 27°CDB, 19.5°CWB, Outdoor temp.: 35°CDB, Equivalent piping length: 7.5 m, Level difference: 0 m.
(*2) Indoor temp.: 27°CDB, 19°CWB, Outdoor temp.: 35°CDB, Equivalent piping length: 7.5 m, Level difference: 0 m.
•Heating: Indoor temp.: 20°CDB, Outdoor temp.: 7°CDB, 6°CWB, Equivalent piping length: 7.5 m, Level difference: 0 m.

• Sound level: Anechoic chamber conversion value, measured at a point 1 m in front of the unit at a height of 1.5 m. During actual operation, these values are normally somewhat higher as a result of ambient conditions and oil recovery mode. When there is concern for noise the surrounding area such as residences, we recommend investigating the installation location and taking soundproofing measures.

VRV IV Q SERIES
Heat Pump

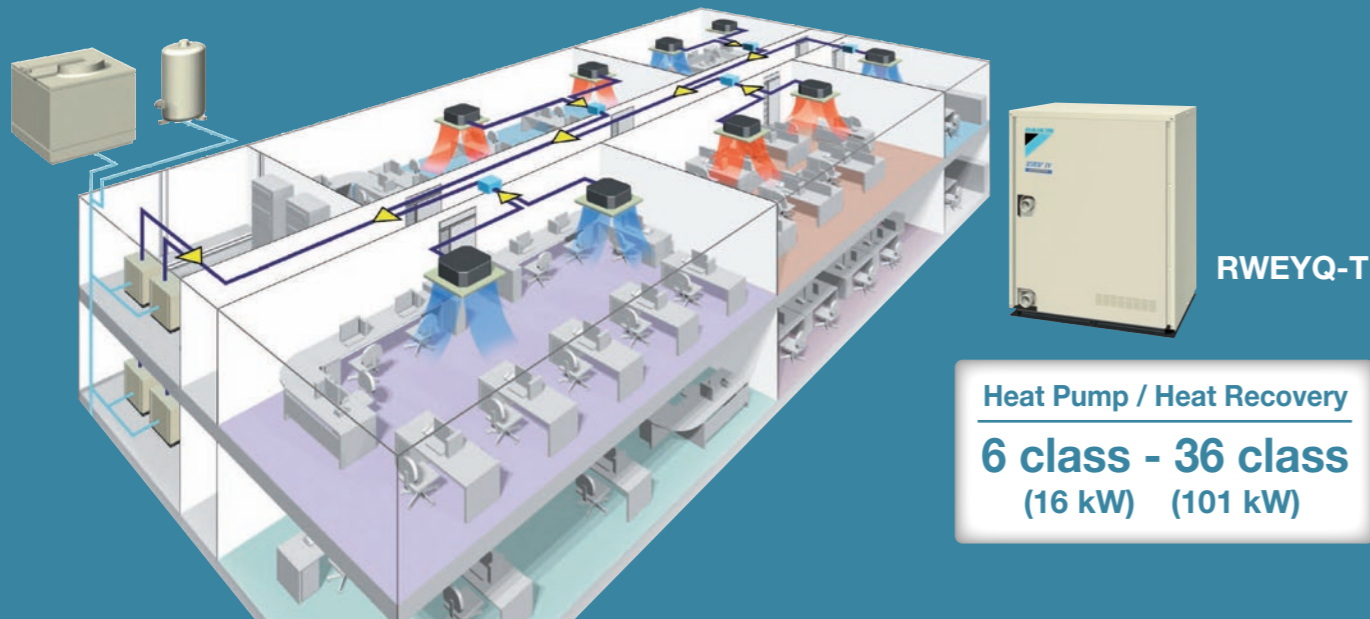

A water cooled intelligent individual air conditioning system suitable for tall multi-storey buildings.

What is a water cooled system?

While an air cooled air conditioning system is designed to exchange heat recovered from indoors with outdoor air, a water cooled air conditioning system is designed for heat exchange with water Cooling Tower.

Air cooled system

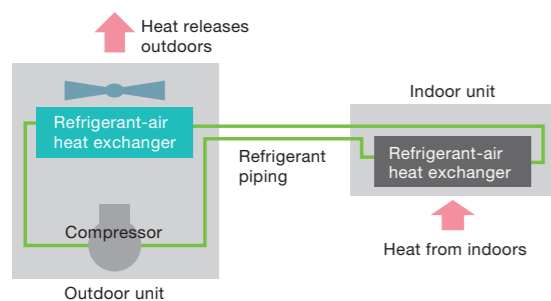

Water cooled system

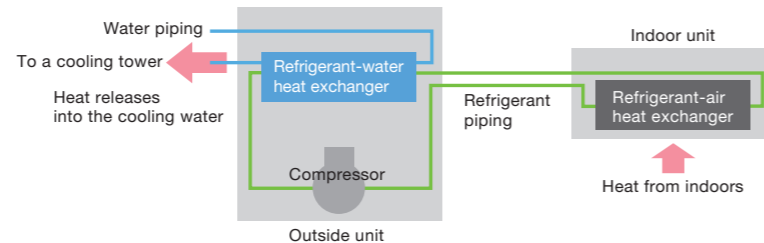

As a water cooled system does not require to exchange heat with outdoor air,

- Outside units can be installed indoors, for example, on basement floors.
→ **High installation flexibility**

- The air conditioning operation is stable even when the outdoor air temperature is high.
→ **Improved comfort**

The VRV IV W series combines the characteristics of a water cooled system with the VRV system

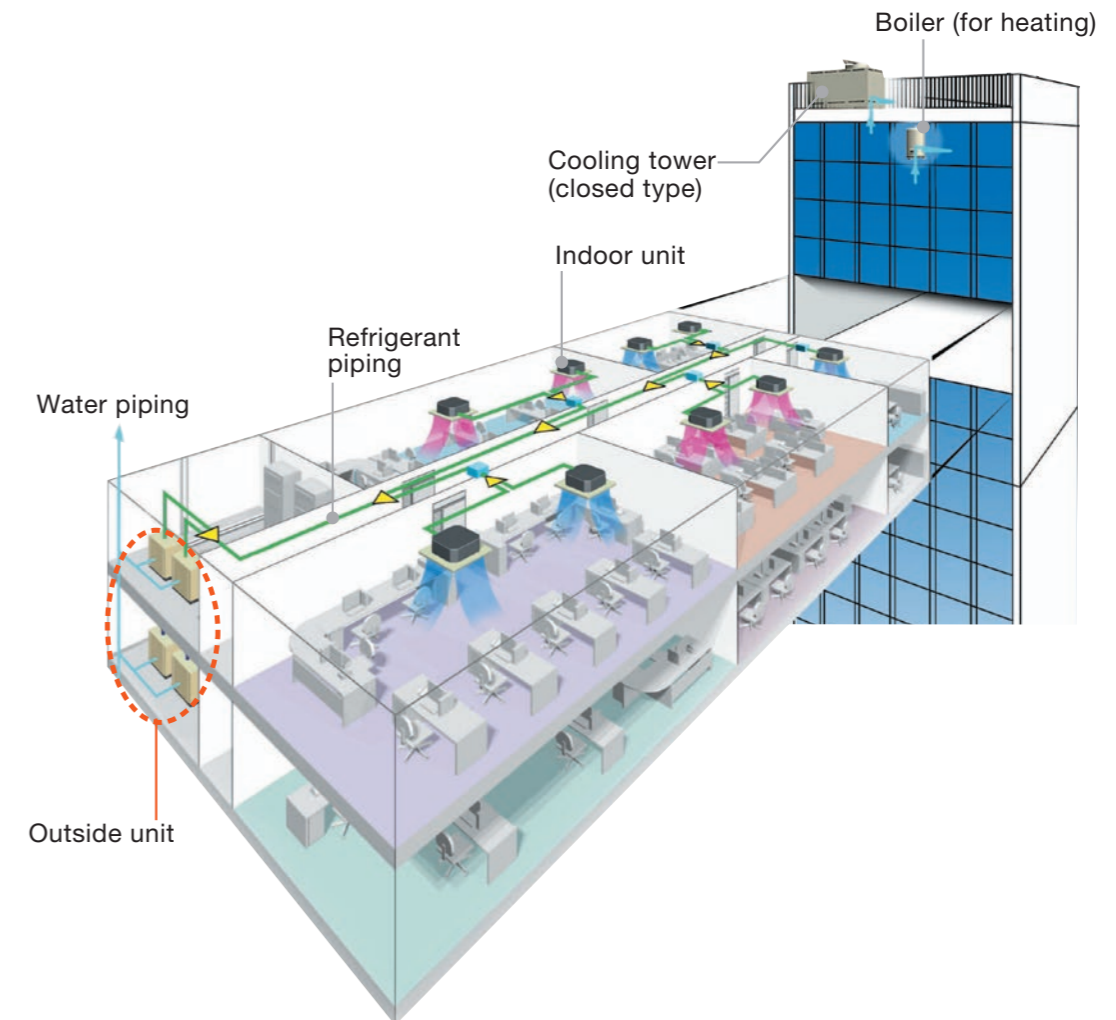

- Individual air conditioning is achieved via on-demand operation in each room.
- Outside units can be installed internally in a building if they can be connected with water piping.
- The length of the refrigerant piping can be minimized by installing outside units in proximity to indoor units.
[The system helps reduce energy loss caused by long refrigerant piping.]
- Refrigerant piping is connected to indoor units.
This design helps reduce the risks of indoor water leakage.

The **VRV IV W** series can meet various air conditioning needs by taking full advantage of the characteristics of a water cooled system.

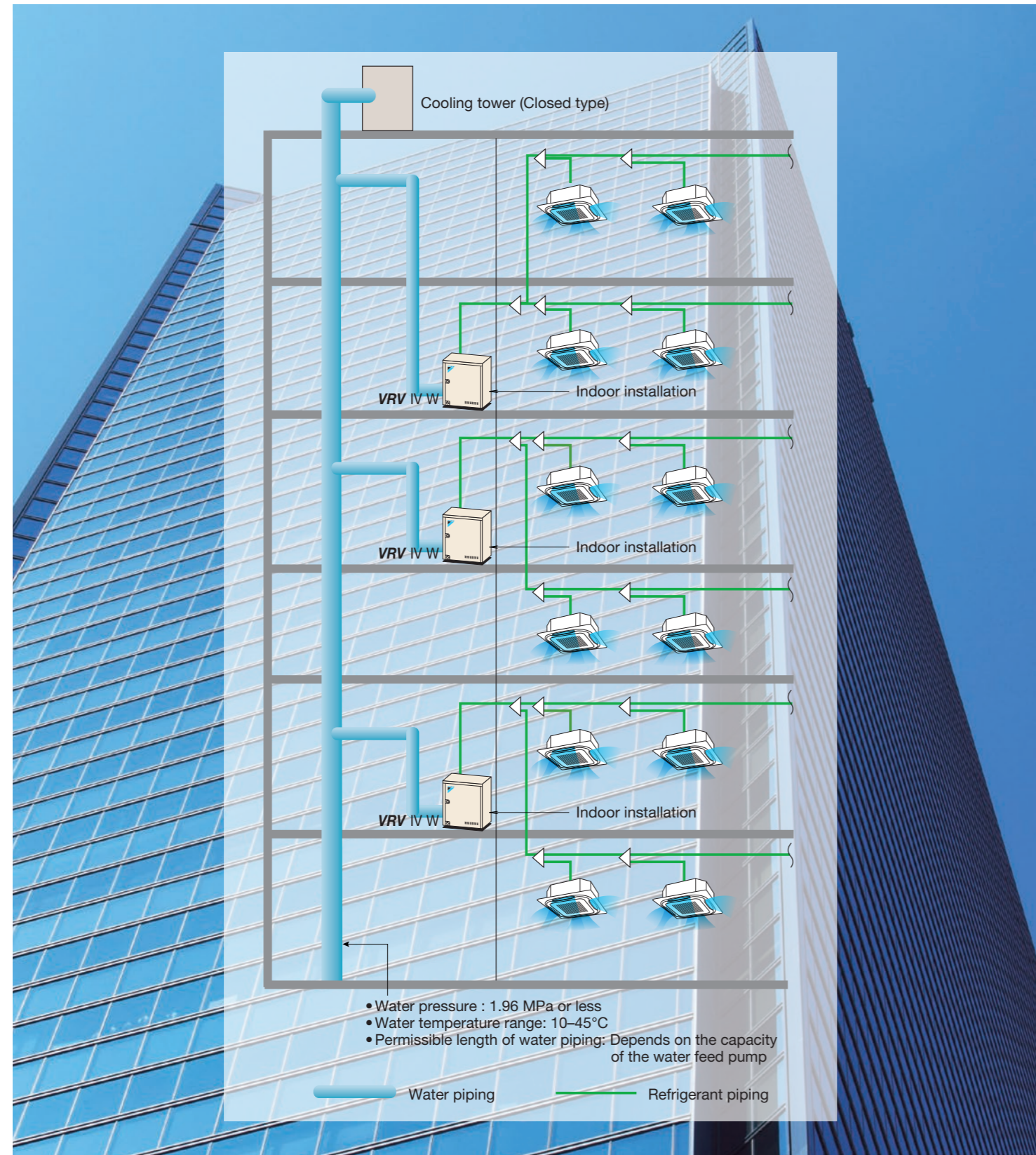

Adaptable to high-rise buildings due to easy installation on each floor

No balcony required

Compact outside units can be easily installed in the machine rooms on each floor. This helps overcome the restriction on differences in height of refrigerant piping. Individual air conditioning can be easily provided in high-rise buildings using this **VRV** system.

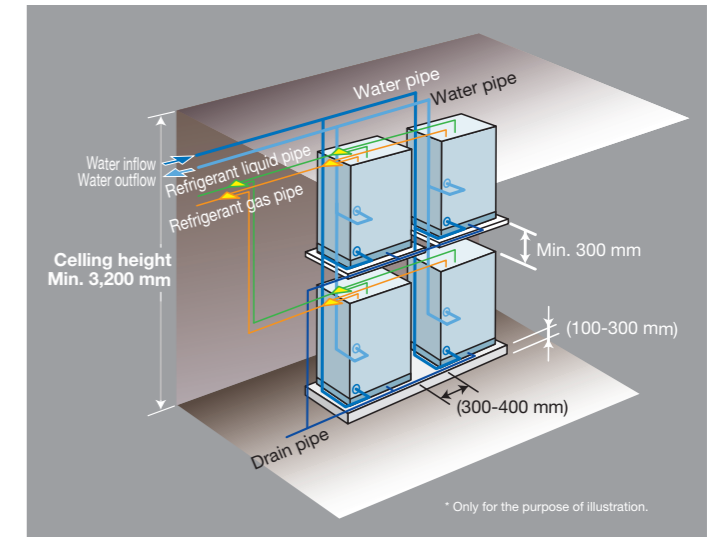
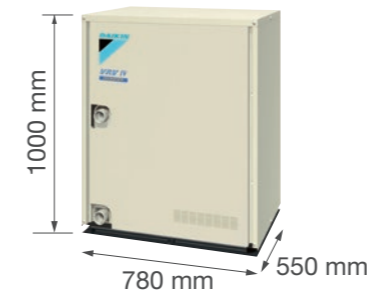

Easy to install in underground shopping malls and subway systems

Individual air conditioning can be easily provided in underground shopping malls, subway systems, etc. using this **VRV** system because heat exchange with outdoor air is not required.

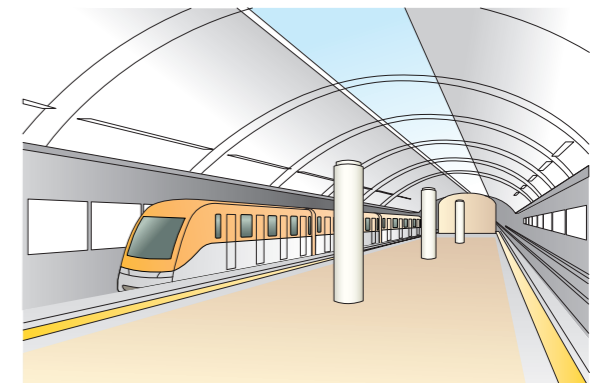

Suitable for high rise residential development

We offer an extensive lineup of small capacity outside units as well as connectable residential indoor units.

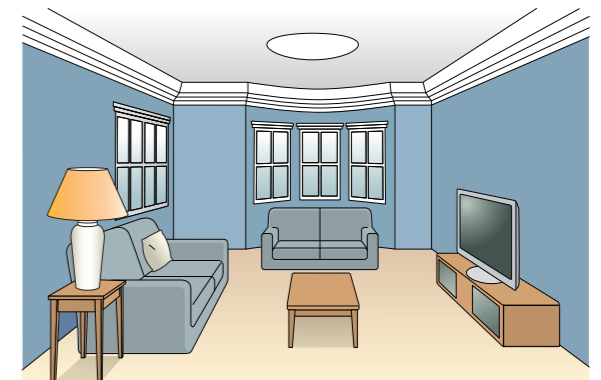

As conventional water based systems age, service and maintenance issues arise

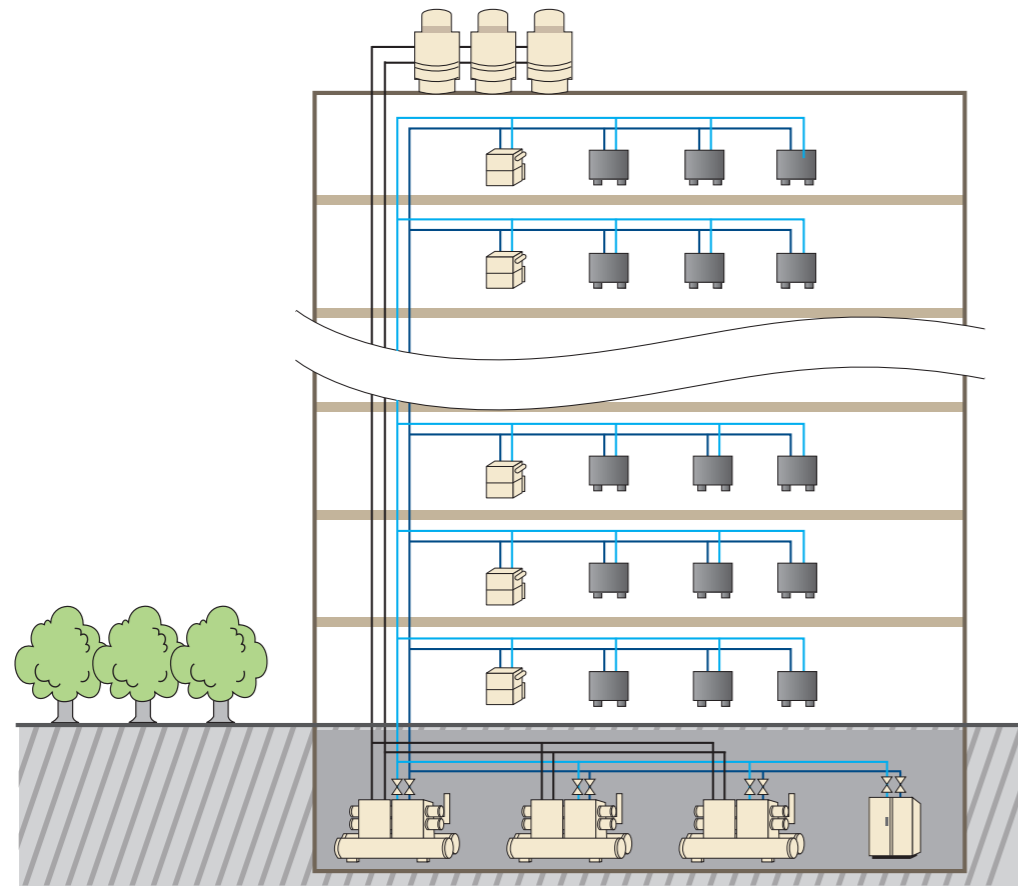

* System diagram

Why is a Retrofit Solution Necessary?

- 1 As equipment age, air-conditioning capacity and performance deteriorates.
- 2 The maintenance cost for the equipment keeps rising.
- 3 After an extended period of operations, the noise generated by the equipment increases.
- 4 Scale formation in water pipes are difficult to clean, impact on performance and leads to corrosion issues.
- 5 Difficulty in catering to new tenancy design changes and requirements.
- 6 Individual energy billing for multi tenancy application is difficult.
- 7 After hours operations for tenants is costly and inefficient.
- 8 Building Management Systems are expensive to install and operate.



Issues to consider in a retrofit project

- 1 How to avoid damaging the building structure?
- 2 How to reduce the impact on tenants during renovation?
- 3 How to bring the renovation costs down to lowest level possible?
- 4 How to securely transport the air conditioning outside unit without incident?
- 5 How to simplify maintenance of the air conditioning system?

A Flexible System Convenient for Expansion / Retrofit Benefits of Water Cooled VRV IV System

1 Outdoor unit located internally

The outside units of the water cooled **VRV IV W** series negates the need of direct heat exchange with outdoor air. This feature makes it possible to place the outside unit room inside the building, which greatly extends design flexibility and makes it easier to adapt to different types of buildings and open to various kinds of creative building exteriors.

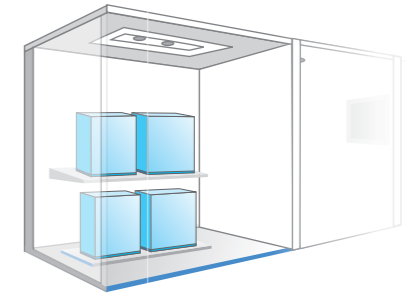

2 Part of the old system can be retained for cost reduction

The water cooled **VRV IV W** series can retain the cooling tower and boiler of the old system during renovation, effectively keeping costs down.

Note:
Closed circuit is necessary. In case of Open Towers, use of Plate Heat Exchanger is required between Open Tower and condenser water circuit.

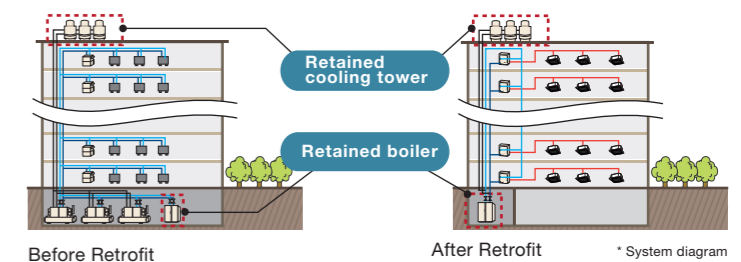

Before Retrofit

After Retrofit

* System diagram

3 Minimal plant room space

- The outside units of the water cooled **VRV IV W** series are conveniently compact, which not only enables transport by elevator possible, but also effectively simplifies installation. This also saves a great deal of time and labor.

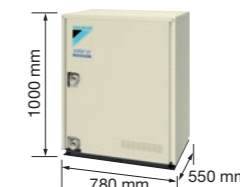

- The modular design featured by the water cooled **VRV IV W** series enables a free and flexible configuration of the outside units. Outside units may be double stacked to minimize plant space.

Stacking up of the outside units

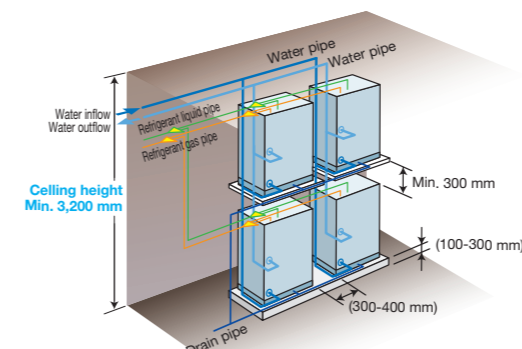

* Only for the purpose of illustration.

Saving more space for other purposes

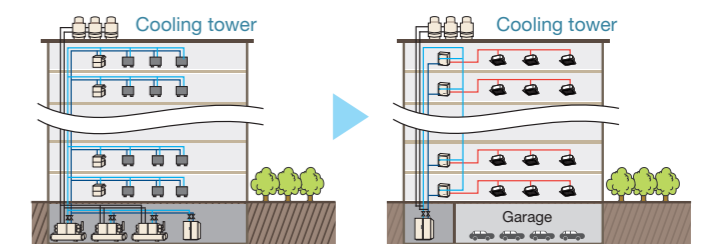

With a conventional central air conditioning system, the outside units take up a disproportionately large amount of space for installation.

With the water cooled **VRV IV W** series, the outside units are modular design and can be arranged more freely and flexibly, saving part of the outside unit room for purposes such as business or car parking.

* System diagram

4 Floor by floor retrofit without interrupting

Based on the actual situation, renovation work can be carried out in phases, and floor by floor. This truly and properly gives expression to the outstanding flexibility of the water cooled VRV IV W series.

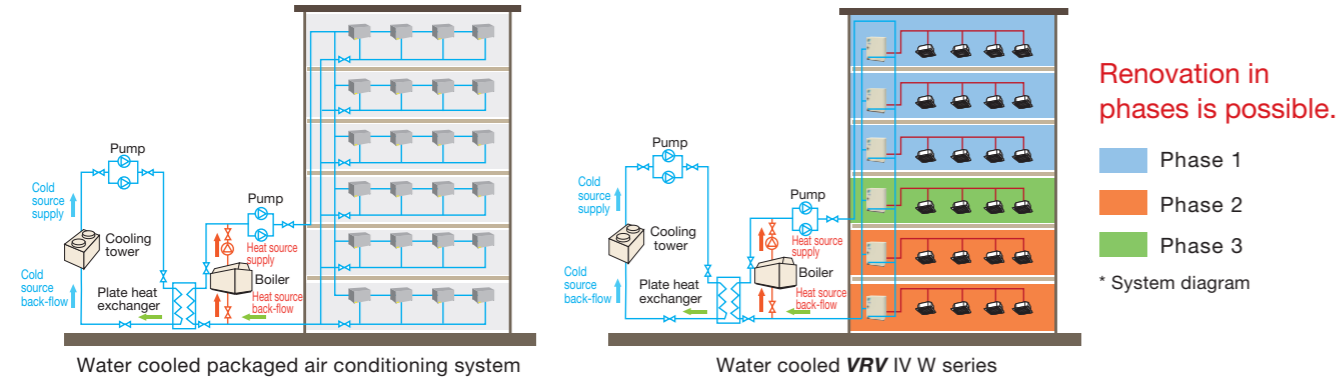

5 Compact refrigerant pipes and VRV indoor units help to free up ceiling space

The outside units and indoor units of the water cooled VRV IV W series are connected by refrigerant pipes. As the VRV indoor units and the diameter of refrigerant pipes are significantly smaller than duct and water pipes, less ceiling space is occupied and more floor height is saved. Less work is needed for expansion and renovation of the air conditioning system, thus minimizing the influence on other tenants.

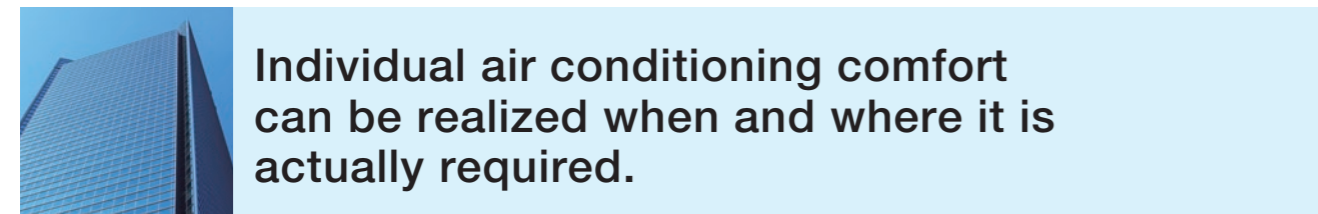

1 Independent control provides greater comfort and convenience

Each indoor unit of the water cooled VRV IV W series can be independently controlled and adjusted according to each tenant's individual needs for temperature and air volume. This achieves optimal comfort and convenience.

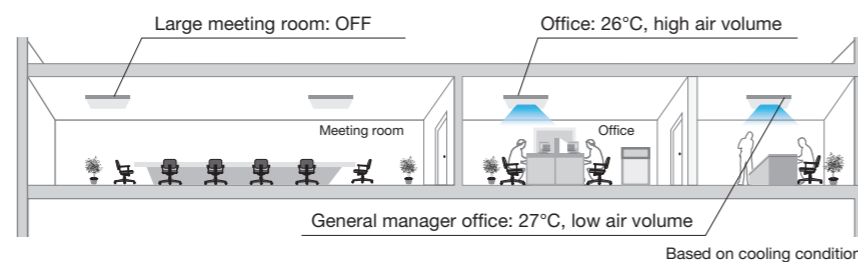

2 Higher efficiency with partial load

An air-conditioning plant operates at partial load for most of the year given the changing nature of both the external and internal loads. By incorporating advanced DC Inverter, Refrigerant Control technology and VRT, Daikin's VRV IV W series is able to deliver superior partial load performances.

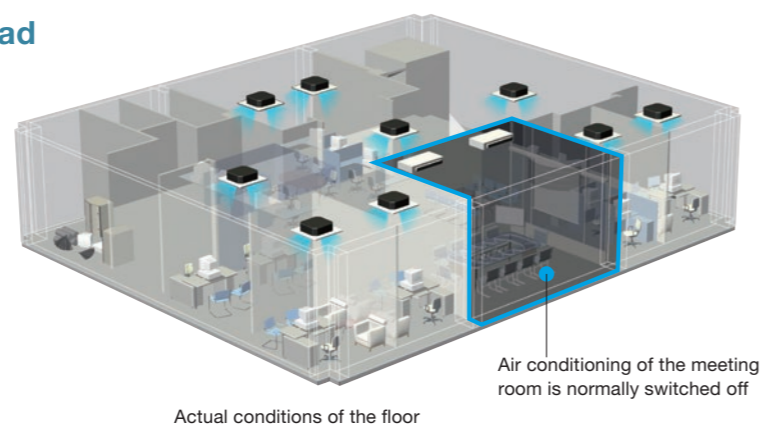

3 Suitable as a low load or supplementary system

When combined up with a conventional central air conditioning system, the water cooled VRV IV W series can easily handle the air conditioning needs for after-hours work while the building's central air conditioner can be utilized during normal work hours. The water cooled VRV IV W series can be added according to actual needs.

- Cumbersome application procedures are eliminated, and the tenants' daily air conditioning costs decrease.
- Based on actual schedules, operation for each indoor unit can be precisely and individually set.

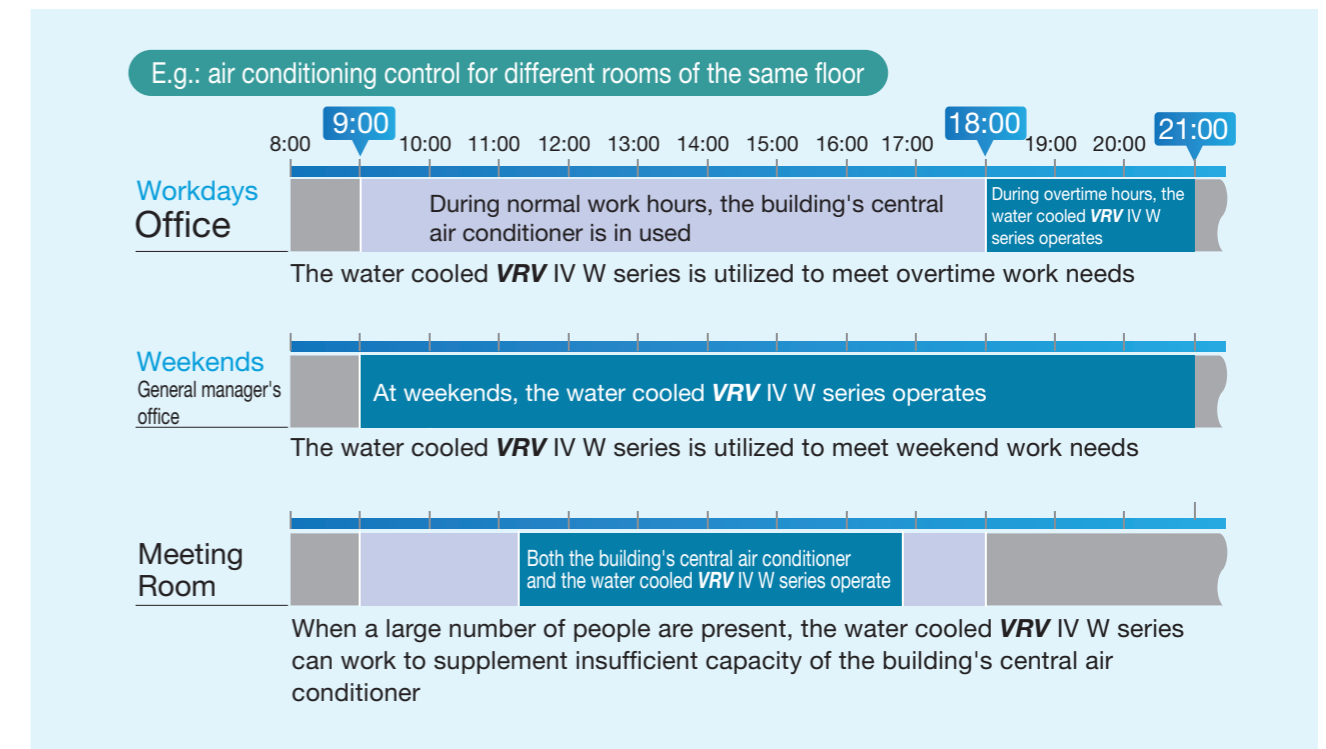

4 Connection using refrigerant pipes eliminate the risk of water leakage

The outside units and indoor units of the water cooled VRV IV W series are connected by refrigerant pipes, with water pipes centralised in the outside unit room and the pipe well. This arrangement greatly reduces the risk of damage of important equipment indoors caused by water leakage of the system.

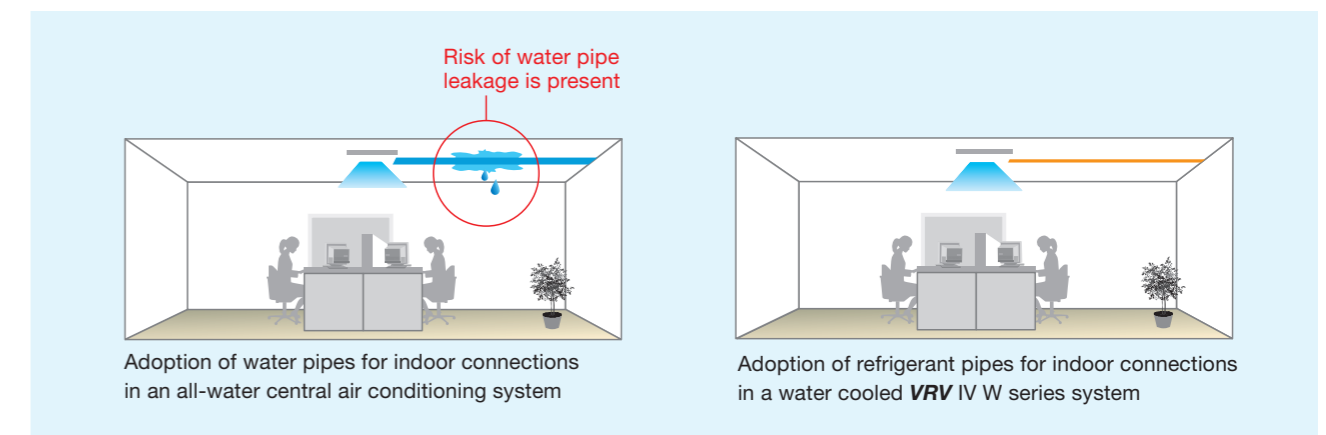

Compact and lightweight

Adoption of a water heat exchanger and optimisation of the refrigerant control circuit has resulted in compact and lightweight equipment. A weight of 146 kg and height of 1,000 mm make it possible for installation in buildings with limited space, or where space is unavailable for outdoor units. This makes the system ideal for places that doesn't have area outside—such as underground malls.

* The unit is designed for indoor installation only.



VRV III W series
24 class(8 class+8 class+8 class)



VRV IV W SERIES
24 class(12 class+ 12 class)



Footprint	1.29 m ²	→	0.86 m ²	33% Decrease
Product Weight	447 kg	→	294 kg	34% Decrease

Enhanced usability

Centralised interlocking function

Centralised interlocking input operate by using an external control adaptor (DTA104A62).

Using one external control adaptor circuit board makes centralised interlocking input to multiple units within the same water system possible.

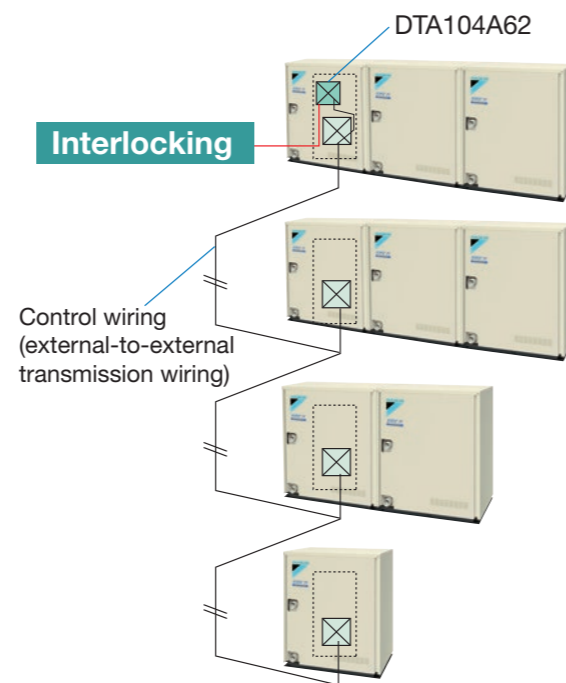

Enhanced lineup

Wider capacity range from 6 to 36 class

With its enhanced lineup of 2 new models-6 class and 12 class single outside units, **VRV IV W series** offers a wider capacity range from 6 class to 36 class to meet broad variety of needs.

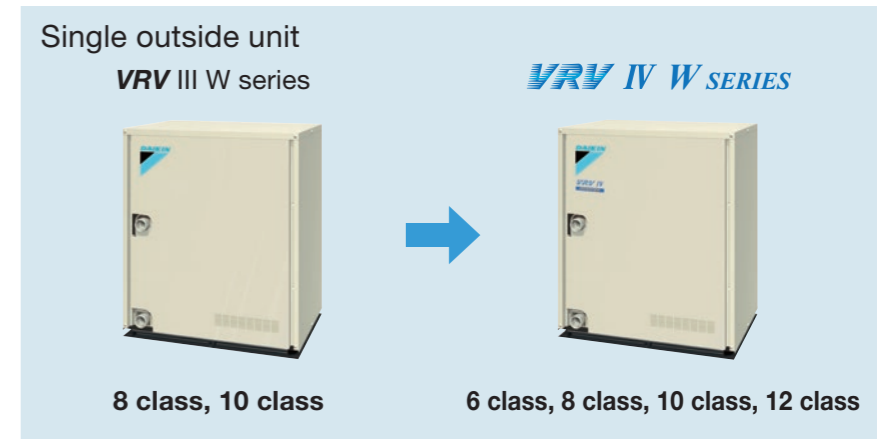

VRV IV W SERIES

6,8,10,12 class	14,16,18,20,22,24 class	26,28,32,34,36 class
RWEYQ6TYM RWEYQ8TYM	RWEYQ10TYM RWEYQ12TYM	RWEYQ14TYM RWEYQ16TYM RWEYQ18TYM
	RWEYQ20TYM RWEYQ22TYM RWEYQ24TYM	RWEYQ26TYM RWEYQ28TYM RWEYQ30TYM
		RWEYQ32TYM RWEYQ34TYM RWEYQ36TYM

Capacity Range	class	kW															
		6	8	10	12	14	16	18	20	22	24	26	28	30	32	34	36
Conventional model VRV III W series			●	●				●	●	●		●	●	●			
VRV IV W SERIES		●	●	●	●	●	●	●	●	●	●	●	●	●	●	●	●

Energy saving

Higher Coefficient of Performance (COP)

It has become essential for air conditioning manufacturers to develop systems that provide high energy savings. At Daikin, we have made great efforts for this purpose, **VRV IV W series** delivers highly efficient performance, contributing to high energy savings.

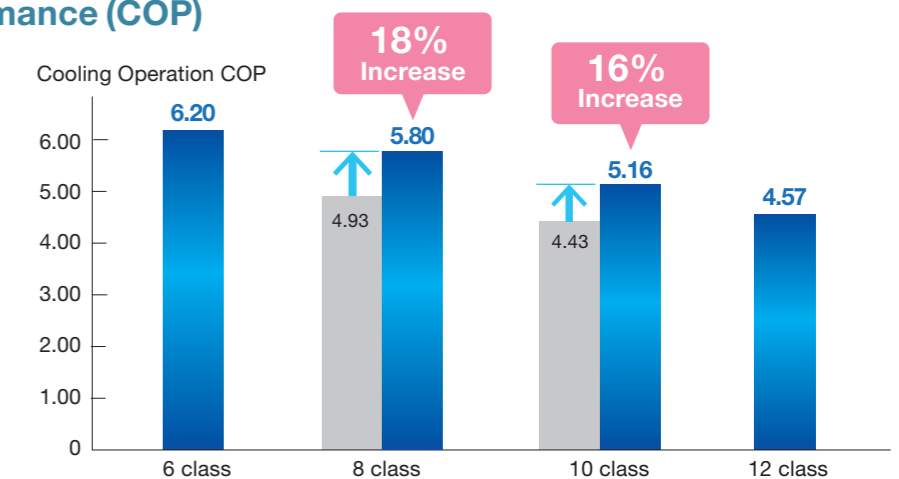

*Cooling : Indoor temp.: 27°CDB, 19°CWB/inlet water temp.: 30°C, Equivalent piping length: 7.5 m, Level difference: 0 m.

State-of-the-art energy saving technology

Customise your VRV system for optimal annual efficiency

The new VRV IV W series now features VRT technology. VRT automatically adjusts refrigerant temperature to individual building and climate requirement, thus further improving annual energy efficiency and maintaining comfort. With this excellent technology, running costs are reduced.

How is energy reduced?

During cooling, the refrigerant evaporating temperature (T_e) is raised to minimise the difference with the condensing temperature. During heating, condensing temperature (T_c) is lowered to minimise the difference to the evaporating temperature. Compressors work less, and this reduces power consumption.

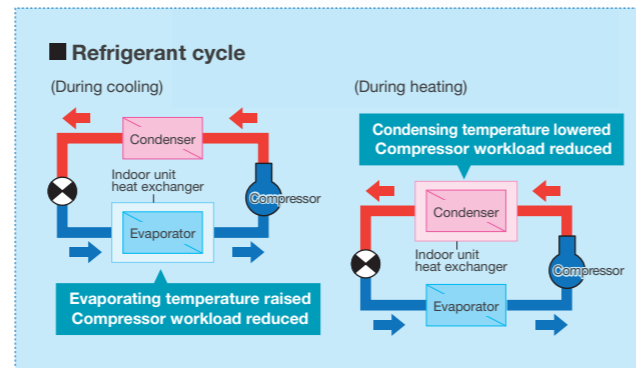

Typical changes in evaporating temperature and COP depending on changing indoor load

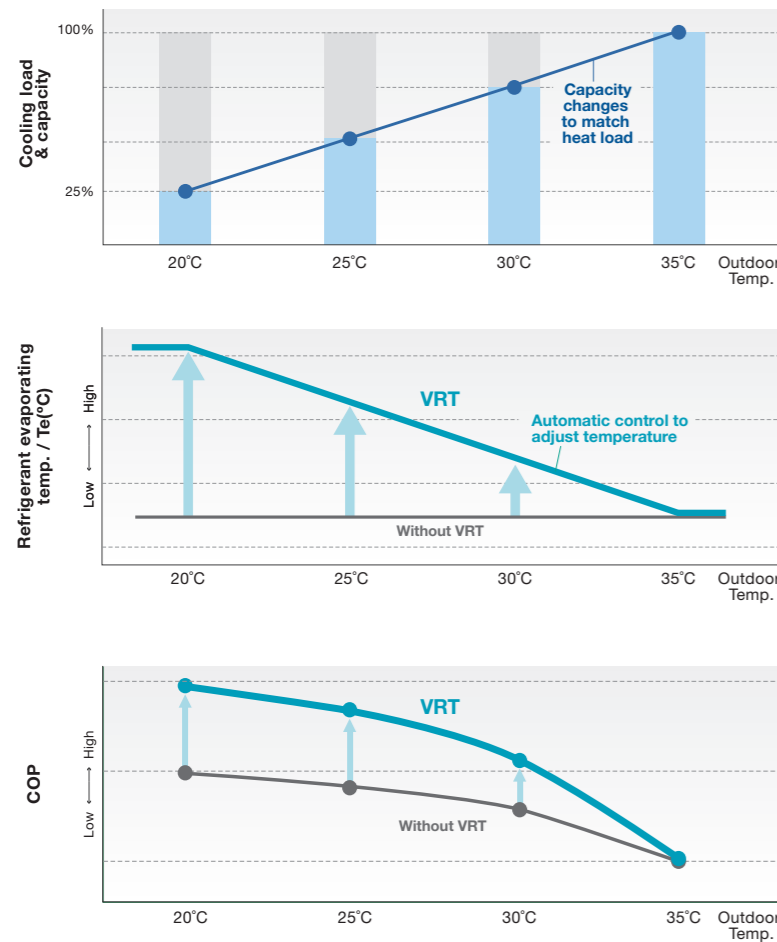

Required capacity changes as air conditioning load changes according to outdoor temperature.

In case of fixed evaporating temperature, excessive cooling, thermo on-off loss, and other inefficiencies occur.

Automatic control adjusts evaporating temperature to heat load change.

Energy efficiency is improved without sacrificing comfort.

* VRT is only available during either all cooling operation or all heating operation.

Long refrigerant piping length

Within the refrigerant piping system, a maximum of 120 m of actual piping length and 50 m of level difference between the VRV IV W series and indoor units are possible. Water piping does not enter occupied spaces, so there is little chance of water leaking.

For connection of only VRV indoor units.

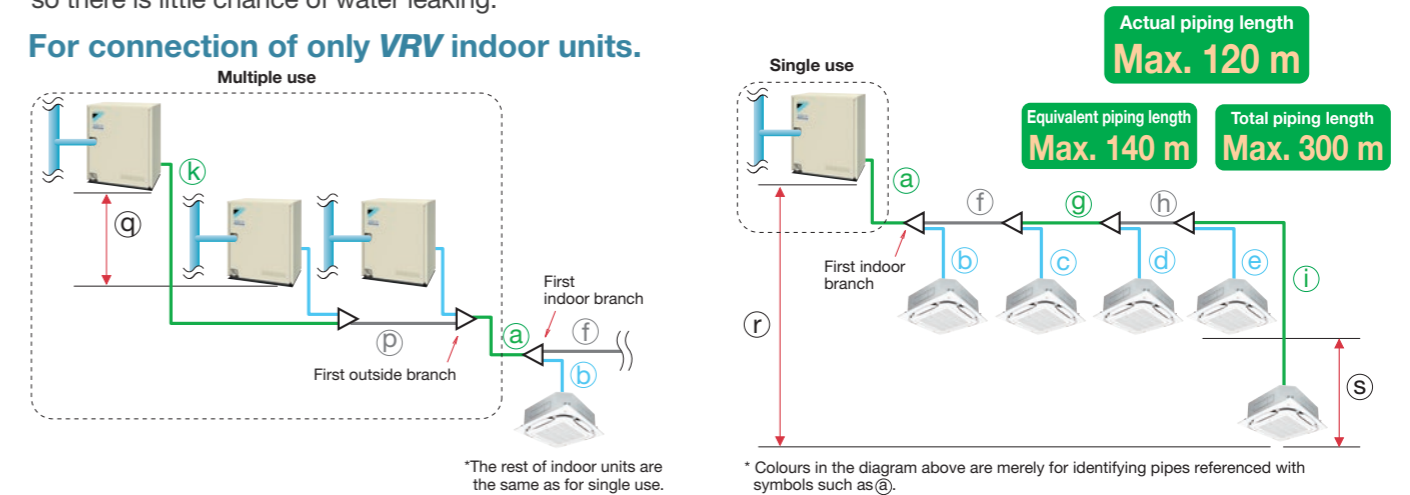

		Actual piping length	Example	Equivalent piping length	
Max. allowable piping length	Refrigerant piping length	120 m	a+f+g+h+i	140 m	
	Total piping length	300 m	a+b+c+d+e+f+g+h+i	—	
	Between the first indoor branch and the farthest indoor unit	90 m ^{*1}	f+g+h+i	—	
Max. allowable level difference	Between the first outside branch and the last outside unit	10 m	k+p	13 m	
	Between the outside units (multiple use)	2 m	q	—	
	Between the indoor units	15 m	s	—	
	Between the outside units and the indoor units	If the outside unit is above. If the outside unit is below.	50 m 40 m	r r	— —

*1 No special requirements up to 40 m. The maximum actual piping length can be 90 m, depending on conditions. The VRV IV W series is easy to extend to 90 m by lessening the conditions from conventional VRV III W models. Be sure to refer to the Engineering Data Book for details of these conditions and requirements.

For connection of only residential indoor units.

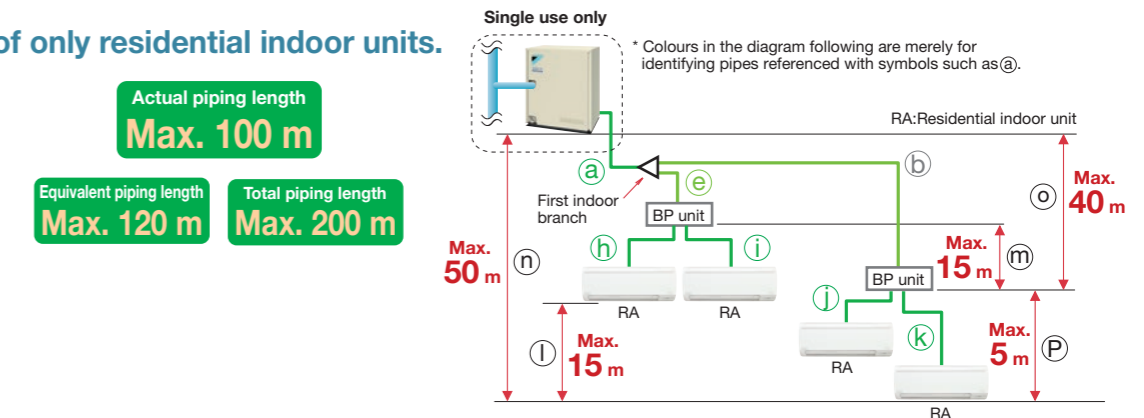

		Actual piping length	Example	Equivalent piping length
Max. allowable piping length	Refrigerant piping length	100 m	a+b+k	120 m
	Total piping length	200 m	a+b+e+h+j+k	—
	Between the first indoor branch and the farthest indoor unit	50 m ^{*1}	b+k	—
Max. and min. allowable piping length	Between BP unit and indoor unit	If indoor unit capacity index < 60 If indoor unit capacity index is 60 If indoor unit capacity index is 71	h,i,j,k h,i,j,k h,i,j,k	— — —
	Between the outside unit and the indoor unit	If the outside unit is above. If the outside unit is below.	50 m 40 m	n n
	Between the indoor units	15 m	l	—
Max. allowable level difference	Between the outside unit and the BP unit	40 m	o	—
	Between BP units	15 m	m	—
	Between the BP unit and the indoor unit	5 m	p	—

*1. When the piping length exceeds 20 m, the size of the main pipes (the gas side and the liquid side) must be increased. Please refer to Engineering Data Book for details.

High efficiency compressor to achieve a high COP

Compressor equipped with Reluctance DC motor

Daikin DC inverter models are equipped with the Reluctance DC motor for compressor. The Reluctance DC motor uses 2 different types of torque, neodymium magnet*1 and reluctance torque*2. This motor can save energy because it generates more power with a smaller electric power than an AC or conventional DC motor.

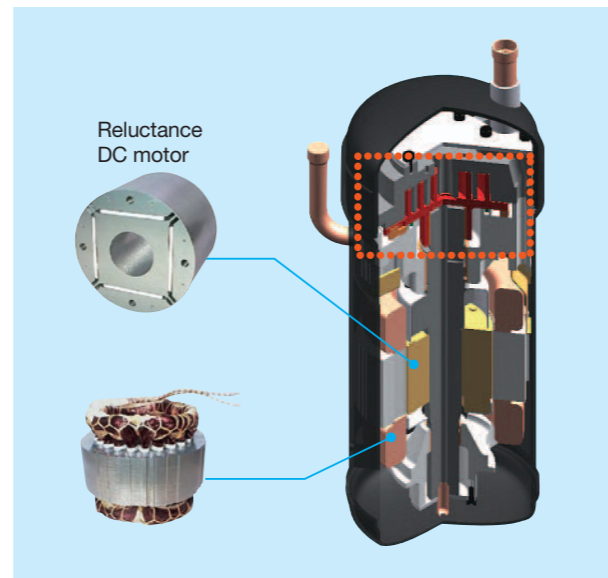
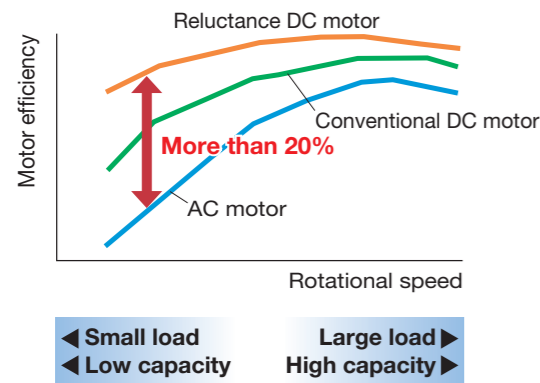

Note: Data are based on studies conducted under controlled conditions at a Daikin laboratory using Daikin products.

*1 A neodymium magnet is approximately 10 times stronger than a standard ferrite magnet.

*2 The torque created by the change in power between the iron and magnet parts.

Smooth sine wave DC inverter

Use of an optimised sine wave smoothes motor rotation, further improving operating efficiency.

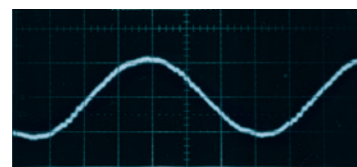

Scroll compressor

Sucked gas is compressed in the scrolling part before the heated motor, so that the machine compresses the non-expanded gas, resulting in high efficiency compression.

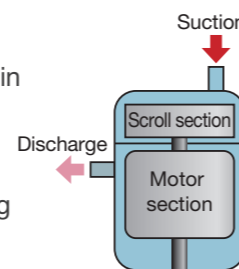

Advanced control main PC board

SMT* packaging technology

- SMT packaging technology adopted by the whole computer control panel improves the anti-clutter performance.
- Protects your computer boards from the adverse effect of sandy and humid weather.

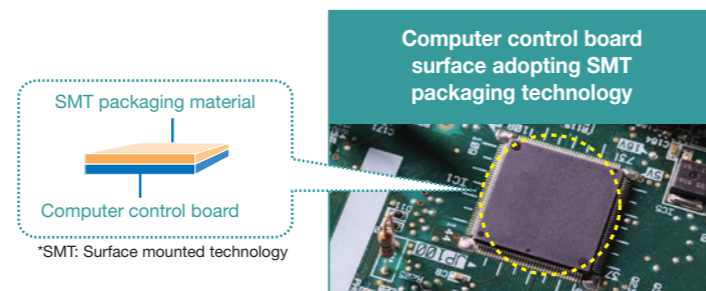

Minimize performance degradation from refrigeration oil in all stages of operation

Newly designed oil receiver

Adding a container vessel (Oil Receiver) helps eliminate performance degradation by retaining refrigeration oil and preventing excessive oil from flowing to the heat exchanger. The new design enables the oil receiver to automatically supply the compressor with only the necessary amount of oil.

Conventional VRV III W series

Refrigeration oil discharged from the compressor circulates in the refrigerant cycle and lowers the heat transfer capabilities of the indoor and outside unit heat exchangers.

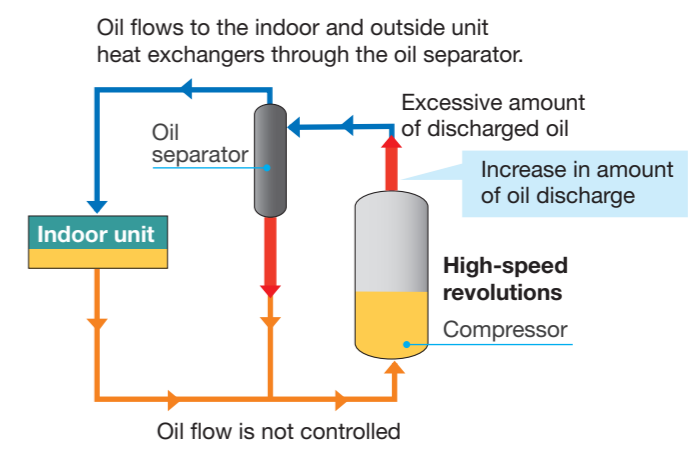
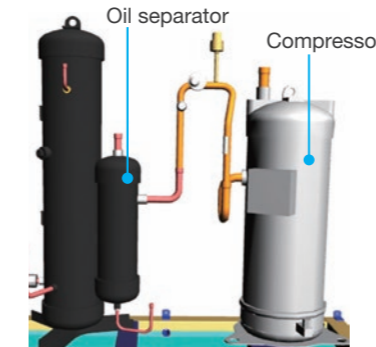

VRV IV W SERIES

Surplus oil is stored in the oil receiver and automatically controls the amount of refrigeration oil in the refrigerant cycle. This prevents a reduction in performance for heat exchanger.

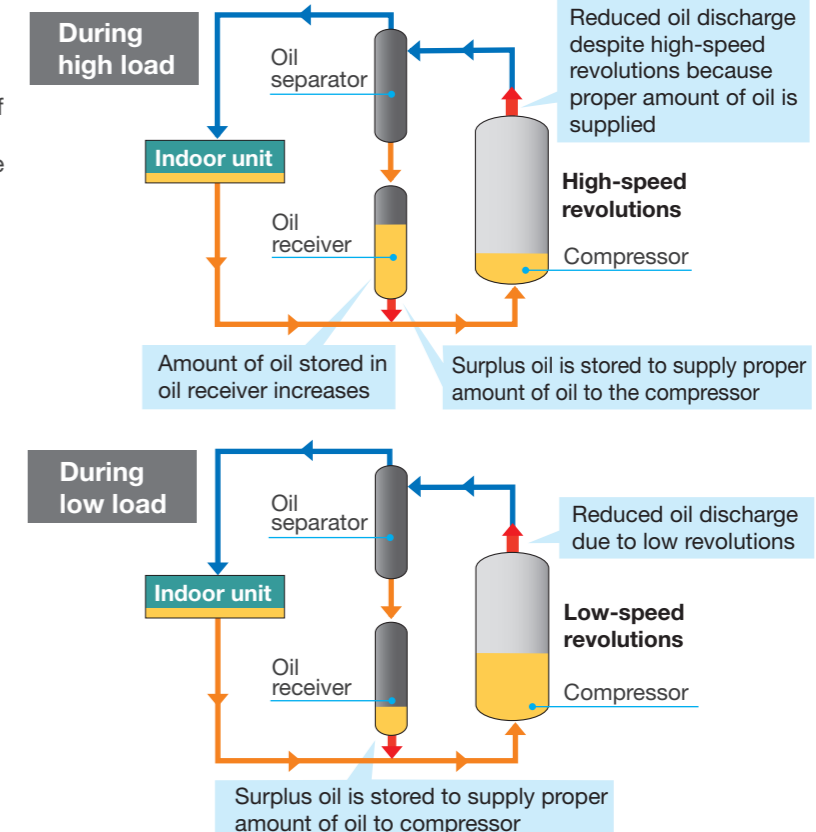
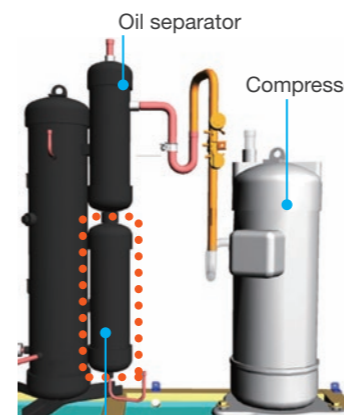

Simplified commissioning and after-sales service

Function of information display by luminous digital tube

VRV IV W series utilises 7-segment luminous digital tubes to display system operation information, enabling the operational state to be visually displayed whilst facilitating simplified commissioning and after-sales service.

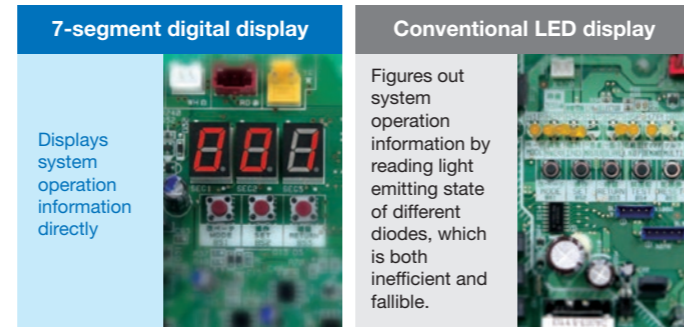

Outside unit sequencing technology

Automatic sequencing operation

During start-up, Daikin VRV IV W series outside unit sequencing operation will be automatically enabled to ensure balanced operation of each outdoor unit to improve longevity of equipment and stable operation.

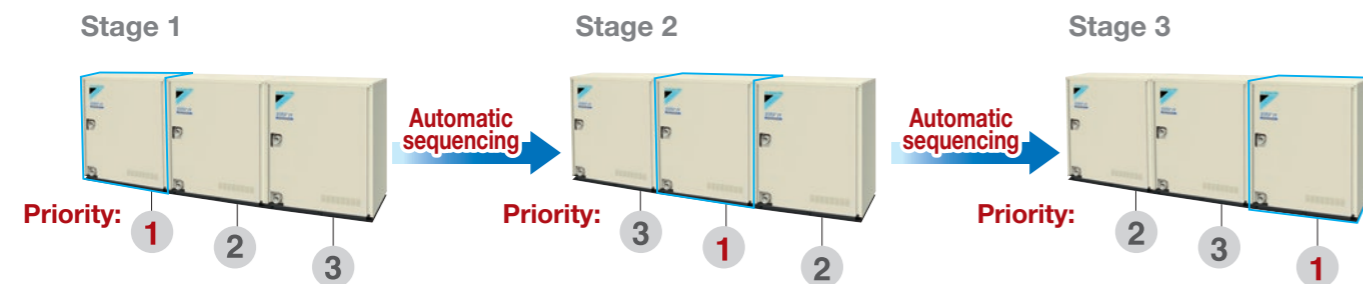

Reliable and convenient air conditioning system

Auto-restart technology after power interruption

Even if the indoor or outside unit accidentally experiences a power interruption during normal operation, the system will keep a record of the operating mode adopted before the power interruption. When the power supply recovers, the air conditioning system will then restore itself back into the recorded operating status, simplifying the operation after an accidental power interruption.

Refrigerant pressure detection technology makes system operation more stable and efficient

Quick and accurate detection of the system's refrigerant status is crucial to the stable and efficient operation of the system. The water cooled VRV IV W series not only utilizes temperature sensors to detect the system's operating status, but also employs high and low pressure sensors to carry out a quick, comprehensive and accurate detection of the system's refrigerant status, ensuring more stable and efficient operation.

More stable operation

Low pressure protection: the system can effectively protect the compressor from being affected by instantaneous low pressure changes through monitoring the pressure data of the air suction pipe. Compared with the conventional low pressure protection method featuring temperature sensors, the pressure-sensor method boasts quicker response and can better reflect the system's instantaneous operating status.

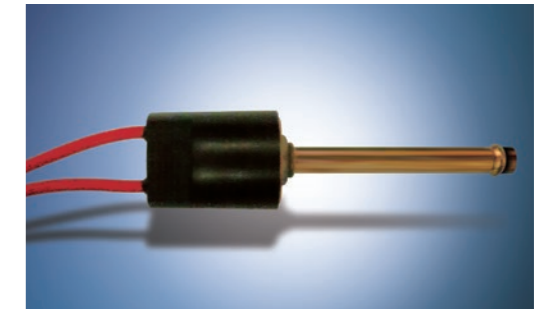

High pressure protection: the system can also keep the compressor from being affected by instantaneous high pressure changes.

More efficient operation

A low pressure sensor, together with advanced supercooling technologies and high pressure protection control, helps to realize fast starting of the compressor, and can also quickly adjust rotational speed according to refrigerant status to adjust to indoor load fluctuations more rapidly.

Outside Unit Combinations

For connection of only VRV indoor units

class	kW	Capacity index	Model	Combination	Total capacity index of connectable indoor units ^{*2}	Maximum number of connectable indoor units
6	16.0	150	RWEYQ6T	RWEYQ6T × 1	75 to 195	9
8	22.4	200	RWEYQ8T	RWEYQ8T × 1	100 to 260	13
10	28.0	250	RWEYQ10T	RWEYQ10T × 1	125 to 325	16
12	33.5	300	RWEYQ12T	RWEYQ12T × 1	150 to 390	19
14	38.4	350	RWEYQ14T ⁻¹	RWEYQ6T + RWEYQ8T	175 to 455	22
16	44.8	400	RWEYQ16T ⁻¹	RWEYQ8T × 2	200 to 520	26
18	50.4	450	RWEYQ18T ⁻¹	RWEYQ8T + RWEYQ10T	225 to 585	29
20	56.0	500	RWEYQ20T ⁻¹	RWEYQ10T × 2	250 to 650	32
22	61.5	550	RWEYQ22T ⁻¹	RWEYQ10T + RWEYQ12T	275 to 715	35
24	67.0	600	RWEYQ24T ⁻¹	RWEYQ12T × 2	300 to 780	39
26	72.8	650	RWEYQ26T ⁻¹	RWEYQ8T × 2 + RWEYQ10T	325 to 845	42
28	78.4	700	RWEYQ28T ⁻¹	RWEYQ8T + RWEYQ10T × 2	350 to 910	45
30	84.0	750	RWEYQ30T ⁻¹	RWEYQ10T × 3	375 to 975	48
32	89.5	800	RWEYQ32T ⁻¹	RWEYQ10T × 2 + RWEYQ12T	400 to 1,040	52
34	95.0	850	RWEYQ34T ⁻¹	RWEYQ10T + RWEYQ12T × 2	425 to 1,105	55
36	101	900	RWEYQ36T ⁻¹	RWEYQ12T × 3	450 to 1,170	58

*1. An outside unit multi connection piping kit (option) is necessary for multiple connections of 14 class systems and above.

*2. Total capacity index of connectable indoor units must be 50%–130% of the capacity index of the outside units.

For connection of only residential indoor units

Model name ¹	kW	class	Capacity index	Total capacity index of connectable indoor units ^{*2}			Maximum number of connectable indoor units
				Combination (%) ²			
				80% ²	100%	130%	
RWEYQ6T	16.0	6	150	120	150	195	9
RWEYQ8T	22.4	8	200	160	200	260	13
RWEYQ10T	28.0	10	250	200	250	325	16
RWEYQ12T	33.5	12	300	240	300	390	19

*1. Only single outside unit (RWEYQ6-12T) heat pump type can be connected.

*2. Total capacity index of connectable indoor units must be 80%–130% of the capacity index of the outside unit.

Easily responds to simultaneous heating and cooling needs.

Offers simultaneous cooling and heating operation on the same floor!

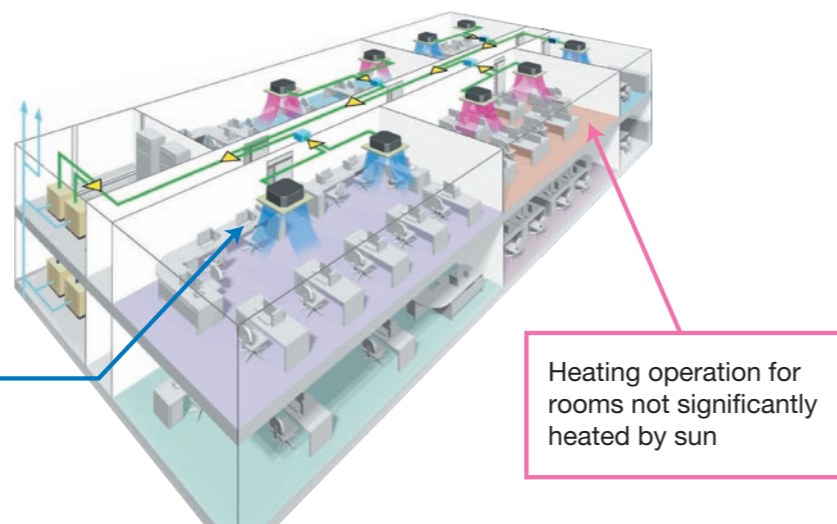

Increasing demand for simultaneous cooling and heating needs

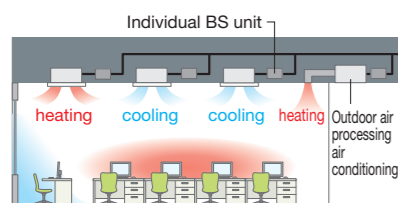

Winter season (Office Building)

- Difference between the load of cold air and heat from room is large
- Can be use with the outdoor air processing air conditioning

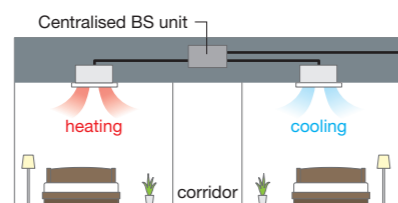

Winter season (Hotel)

- Able to cater to individual heating and cooling requirement

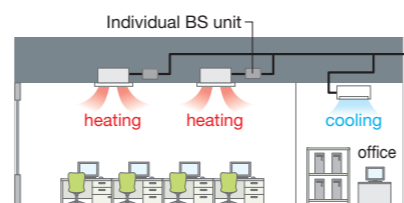

Individual office

- Provides heating and annual cooling depending on space area

BS unit (Individual type/Centralised type)

By adding suction gas piping and a BS unit (sold separately), simultaneous cooling and heating operation can be provided by a single system.

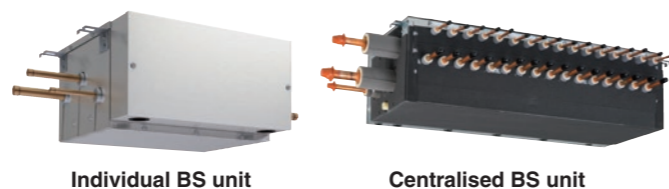

Heat pump

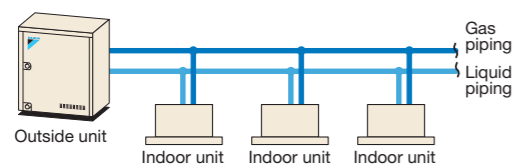

* For indoor units used for cooling only (do not connect to BS unit when using for heat recovery), total capacity index must be 50% or less than the capacity index of the outdoor units.

Heat recovery

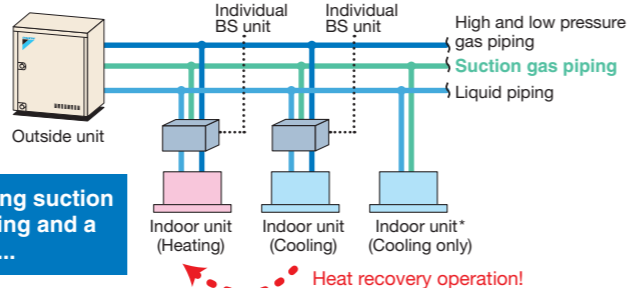

By adding suction gas piping and a BS unit...

2-stage heat recovery operation improves energy efficiency

Daikin offers 2-stage heat recovery operation.

The first stage of heat recovery operation is within the refrigerant system.

By controlling the BS unit that switches cooling and heating, simultaneous cooling and heating operation is made possible, with heat recovery performed between indoor units.

The second stage of heat recovery operation is within the water loop, where heat recovery is performed between the VRV IV W systems.

This 2-stage heat recovery operation substantially improves energy efficiency and makes the system the ideal solution to the requirements of modern office buildings, where some areas may require cooling even in winter, depending on the amount of sunshine received and the number of people in the room.

Stage 1

Simultaneous heating and cooling operation within the refrigerant system.

In mainly cooling, partly heating mode, the system recycles heat exhausted from the cooling operation to use for heating. In mainly heating, partly cooling mode, the system uses cooled post-heating operation refrigerant for cooling. Efficiency improves the more simultaneous operation is performed.

The first stage: Between indoor units

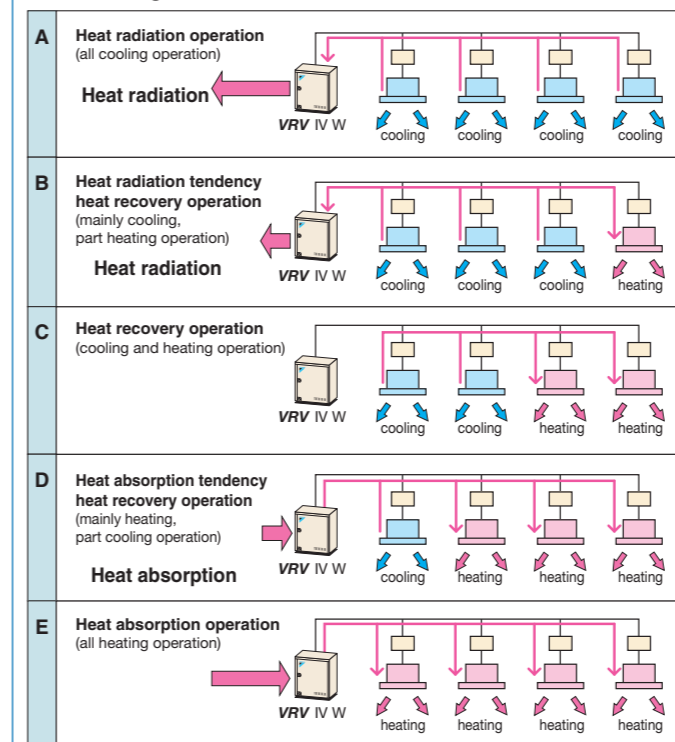

Stage 2

Heat recovery operation between the VRV IV W systems.

Heat recovery operation is also available between systems connected to the same water loop, with systems exchanging heat via water. This increases energy efficiency.

The second stage: Between VRV IV W systems

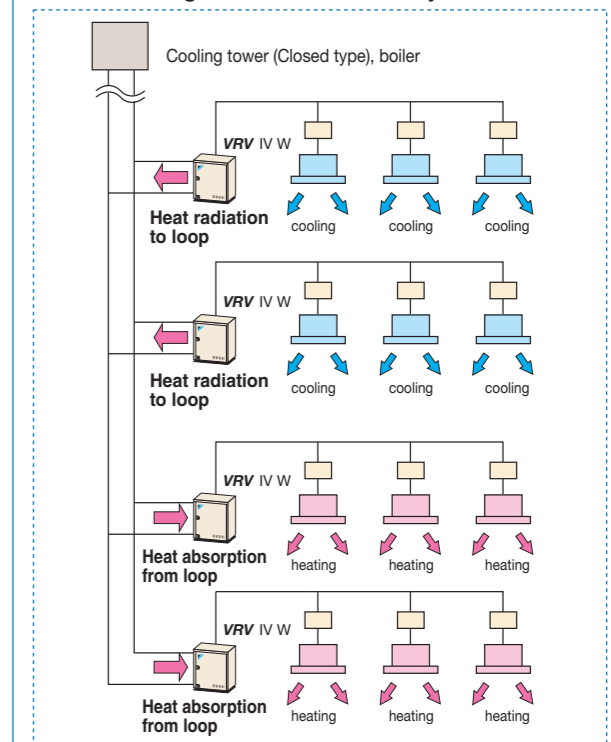

Note: • Above system configurations are for illustration purposes only.

Individual and centralised BS unit allow greater design flexibility

Individual BS unit



BSQ100AV1
BSQ160AV1
BSQ250AV1

- Compact and flexible installation
- Flexible design
- Low noise

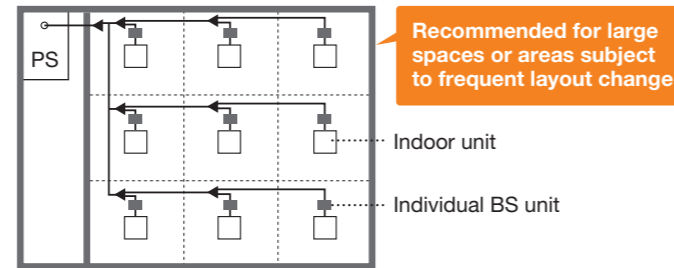

Centralised BS unit



BS4Q14AV1
BS6Q14AV1
BS8Q14AV1
BS10Q14AV1
BS12Q14AV1
BS16Q14AV1

Enhanced Line up

No. of branches	4	6	8	10	12	16
Conventional Centralised BS Unit	●	●				
Centralised BS Unit	●	●	●	●	●	●

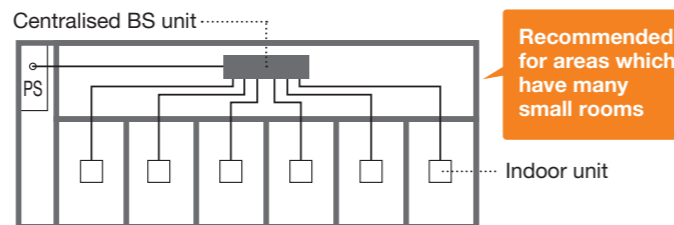

Compact and lightweight design

Compared to conventional BS unit (6 branch)

BS unit size **reduced by 65%**
BS unit weight **reduced by 73%**

Installation and maintenance work have been made easier through the integration of multiple BS units.

Individual BS unit

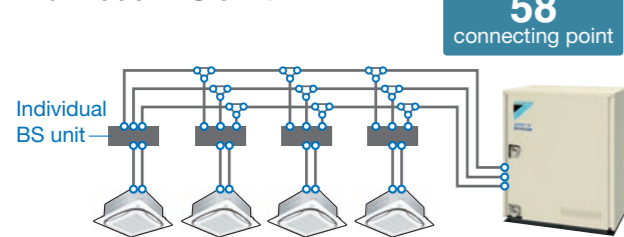

Centralised BS unit

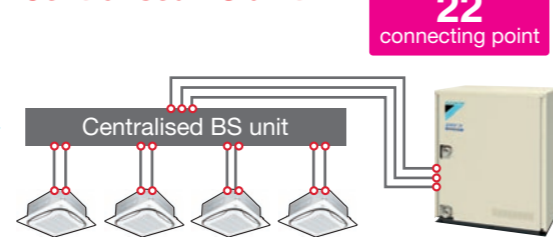

*Centralised BS unit requires drain pipe

Greater design flexibility achieved by increasing the connection capacity range

Centralised BS unit

Increased from **2.2–16.0 kW**
(Up to 11.2 kW in the conventional system)

Centralised BS unit

By merging two branches
Adaptable up to **28.0 kW**

Combined use of a centralised BS unit and individual BS units meets the needs of many design plans.

Availability of individual type and centralised type BS units can better satisfy different design needs, with the former catering flexibly to independent spaces, and the latter for more convenient system installation and maintenance.

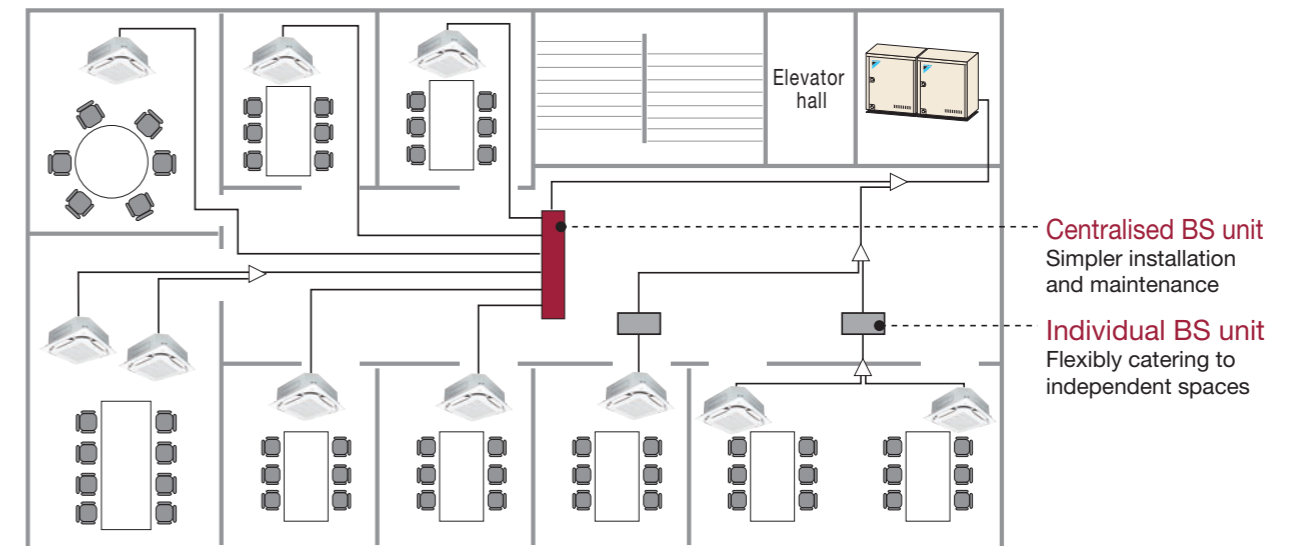

Faster installation of centralised BS unit thanks to open connection

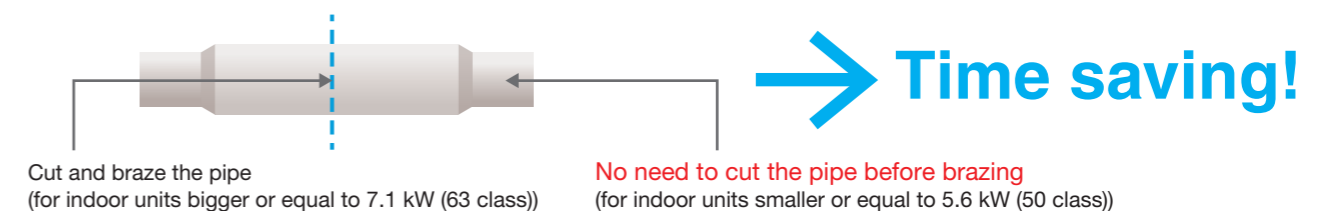

Lower transient sound

New BS units achieve lower transient sound level than conventional BS units.

Maximum transient sound		Centralised BS unit						Individual BS unit		
		4 branch	6 branch	8 branch	10 branch	12 branch	16 branch	100 type	160 type	250 type
New BS units	Sound level (dB(A))*	45	47	47	48	48	49	40	45	45
Conventional BS units	Sound level (dB(A))*	51.5	53.5					45.5	46.5	47.5

*Anechoic chamber conversion value, measured at a point 1 m downward from the unit centre.

Enhanced range of choices

Indoor units can be selected from 2 lineups, both **VRV** and residential indoor units, to match rooms and preferences.

VRV indoor units

● New lineup

Type	Model Name	Capacity Range(kW)	Capacity Index															
			20	25	32	40	50	63	71	80	100	125	140	145	160	180	200	250
			2.2	2.8	3.6	4.5	5.6	7.1	8	9	11.2	14	16	16.2	18	20	22.4	28
Ceiling Mounted Cassette (Round Flow with Sensing)	FXFSQ-AVM			●	●	●	●	●		●	●	●	●					
Ceiling Mounted Cassette (Round Flow)	FXFQ-PVE			●	●	●	●	●		●	●	●						
Ceiling Mounted Cassette (Compact Multi Flow)	FXZQ-A2VEB		●	●	●	●	●											
4-Way Flow Ceiling Suspended	FXUQ-AVEB								●		●							
Ceiling Mounted Cassette (Double Flow)	New FXCQ-AVM		●	●	●	●	●	●		●		●						
Ceiling Mounted Cassette (Single Flow)	FXEQ-AV36		●	●	●	●	●	●										
Slim Ceiling Mounted Duct (Compact Series)	FXDQ-TV1B(A)		●	●	●	●	●											
Slim Ceiling Mounted Duct (Standard Series)	FXDQ-PDVE	 (700mm width type)	●	●	●													
	FXDQ-NDVE	 (900 / 1100mm width type)				●	●	●										
Ceiling Concealed Duct	FXDYQ-MAV1									●	●	●	●					
Middle Static Pressure Ceiling Mounted Duct	FXSQ-PAVE		●	●	●	●	●	●		●	●	●	●					
Ceiling Mounted Duct	FXMQ-PAVE		●	●	●	●	●	●		●	●	●	●					
	FXMQ-PV1A														●	●	●	●
Outdoor-Air Processing Unit	FXMQ-MFV1											●				●	●	
Ceiling Suspended	FXHQ-MAVE				●			●			●							
	New FXHQ-AVM											●	●					
Wall Mounted	New FXAQ-AVM		●	●	●	●	●	●										
Floor Standing	FXLQ-MAVE		●	●	●	●	●	●										
Concealed Floor Standing	FXNQ-MAVE		●	●	●	●	●	●										
Heat Reclaim Ventilator with DX-Coil and Humidifier	VKM-GA(M)V1		Airflow rate 500-1000 m³/h															
Heat Reclaim Ventilator	VAM-GJVE		Airflow rate 150-2000 m³/h															

Residential indoor units with connection to BP units

Type	Model Name	Rated Capacity (kW)	Capacity Index						
			20	25	35	50	60	71	
			2.0	2.5	3.5	5.0	6.0	7.1	
Ceiling Mounted Cassette (Compact Multi Flow)	FFQ-BV1B			●	●	●	●		
Slim Ceiling Mounted Duct	FDXS-CVMA	 (900/1,100 mm width type)		●	●	●	●		
Wall Mounted	FTXS-KVMA		●	●	●				
	FTXS-KAVMA						●	●	●

Note: BP units are necessary for residential indoor units. Only single outside unit (RWEYQ6-12T) heat pump type can be connected.

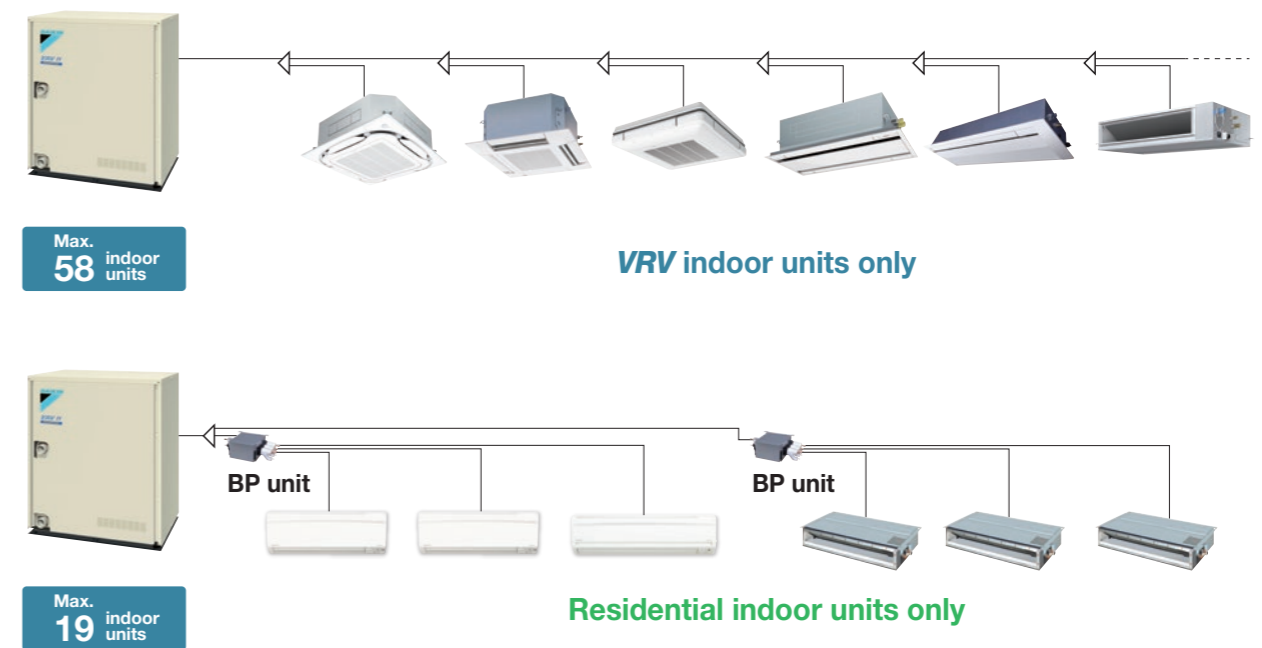





*Refer to page 96 for the maximum number of connectable indoor units.

VRV IV W Series Outside Units

RWEYQ-T

Heat Pump / Heat Recovery

													
MODEL			RWEYQ6TYM	RWEYQ8TYM	RWEYQ10TYM	RWEYQ12TYM	RWEYQ14TYM	RWEYQ16TYM	RWEYQ18TYM	RWEYQ20TYM	RWEYQ22TYM	RWEYQ24TYM	
Combination units			-	-	-	-	-	-	-	-	-	-	
Power supply			3-phase 4-wire system, 380-415 V/380 V, 50/60 Hz				3-phase 4-wire system, 380-415 V/380 V, 50/60 Hz						
Cooling capacity	Btu/h		54,600	76,400	95,500	114,000	131,000	153,000	172,000	191,000	210,000	229,000	
	kW		16.0	22.4	28.0	33.5	38.4	44.8	50.4	56.0	61.5	67.0	
Heating capacity	Btu/h		61,400	85,300	107,000	128,000	147,000	171,000	193,000	215,000	235,000	256,000	
	kW		18.0	25.0	31.5	37.5	43.0	50.0	56.5	63.0	69.0	75.0	
Power consumption	Cooling	kW	2.58	3.86	5.43	7.33	6.44	7.72	9.29	10.9	12.8	14.7	
	Heating	kW	2.69	3.98	5.60	7.87	6.67	7.96	9.58	11.2	13.5	15.7	
Casing colour			Ivory white (5Y7.5/1)				Ivory white (5Y7.5/1)						
Dimensions (HxWxD)			1,000 x 780 x 550				(1,000 x 780 x 550) x 2						
Compressor	Type		Hermetically sealed scroll type				Hermetically sealed scroll type						
	Motor output	kW	1.9	2.8	3.7	4.7	1.9 + 2.8	2.8 x 2	2.8 + 3.7	3.7 x 2	3.7 + 4.7	4.7 x 2	
Refrigerant piping connections	Liquid	mm	φ 9.5 (Flare)				φ 12.7 (Flare)						
	Suction gas *1	mm	φ 19.1 (Brazing)				φ 28.6 (Brazing)						
	High and low pressure gas	mm	φ 19.1*2, φ 19.1*3 (Brazing)				φ 22.2 (Brazing)						
Water piping connections	Water inlet		PT1 1/4B internal thread				(PT1 1/4B) x 2 internal thread						
	Water outlet		PT1 1/4B internal thread				(PT1 1/4B) x 2 internal thread						
	Drain outlet		PS1/2B internal thread				(PS1/2B) x 2 internal thread						
Machine weight (Operating weight)	kg	146 (148)				147 (149)		146 x 2 (148 x 2)		146 + 147 (148 + 149)		147 x 2 (149 x 2)	
Sound level	dB(A)	49	50	51	53	53		54		55	56		
Operation range (Inlet water temp.)	°C	10 to 45				10 to 45							
Capacity control	%	23-100				19-100		23-100		20-100		19-100	
Refrigerant	Type		R-410A				R-410A						
	Charge	kg	3.5				4.2		3.5 + 3.5		3.5 + 4.2		4.2 + 4.2

								
MODEL			RWEYQ26TYM	RWEYQ28TYM	RWEYQ30TYM	RWEYQ32TYM	RWEYQ34TYM	RWEYQ36TYM
Combination units			RWEYQ8TYM	RWEYQ8TYM	RWEYQ10TYM	RWEYQ10TYM	RWEYQ10TYM	RWEYQ12TYM
Power supply			3-phase 4-wire system, 380-415 V/380 V, 50/60 Hz			3-phase 4-wire system, 380-415 V/380 V, 50/60 Hz		
Cooling capacity	Btu/h		248,000	268,000	287,000	305,000	324,000	345,000
	kW		72.8	78.4	84.0	89.5	95.0	101
Heating capacity	Btu/h		278,000	300,000	322,000	345,000	365,000	386,000
	kW		81.5	88.0	94.5	101	107	113
Power consumption	Cooling	kW	13.2	14.7	16.3	18.2	20.1	22.0
	Heating	kW	13.6	15.2	16.8	19.1	21.3	23.6
Casing colour			Ivory white (5Y7.5/1)			Ivory white (5Y7.5/1)		
Dimensions (HxWxD)			(1,000 x 780 x 550) x 3			(1,000 x 780 x 550) x 3		
Compressor	Type		Hermetically sealed scroll type			Hermetically sealed scroll type		
	Motor output	kW	2.8 x 2 + 3.7	2.8 + 3.7 x 2	3.7 x 3	3.7 x 2 + 4.7	3.7 + 4.7 x 2	4.7 x 3
Refrigerant piping connections	Liquid	mm	φ 19.1 (Flare)			φ 19.1 (Flare)		
	Suction gas *1	mm	φ 34.9 (Brazing)			φ 34.9 (Brazing)		
	High and low pressure gas	mm	φ 28.6*2, φ 34.9*3 (Brazing)			φ 28.6*2, φ 34.9*3 (Brazing)		
Water piping connections	Water inlet		(PT1 1/4B) x 3 internal thread			(PT1 1/4B) x 3 internal thread		
	Water outlet		(PT1 1/4B) x 3 internal thread			(PT1 1/4B) x 3 internal thread		
	Drain outlet		(PS1/2B) x 3 internal thread			(PS1/2B) x 3 internal thread		
Machine weight (Operating weight)	kg	146 x 2 + 147 (148 x 2 + 149)	146 + 147 x 2 (148 + 149 x 2)	147 x 3 (149 x 3)	147 x 3 (149 x 3)			
Sound level	dB(A)	55			56	57		58
Operation range (Inlet water temp.)	°C	10 to 45			10 to 45			
Capacity control	%	21-100			20-100		19-100	
Refrigerant	Type		R-410A			R-410A		
	Charge	kg	3.5 + 3.5 + 4.2			3.5 + 4.2 + 4.2		

Note :

- Specifications are based on the following conditions ;
 - Cooling : Indoor temp. : 27°CDB, 19°CWB / inlet water temp. : 30°C, Equivalent piping length : 7.5 m, Level difference : 0 m.
 - Heating : Indoor temp. : 20°CDB / inlet water temp. : 20°C, Equivalent piping length : 7.5 m, Level difference : 0 m.
 - Sound level: Anechoic chamber conversion value, measured at a point 1 m in front of the unit at a height of 1.5 m. During actual operation, these values are normally somewhat higher as a result of ambient conditions and oil recovery mode. When there is concern for noise to the surrounding area such as residences, we recommend investigating the installation location and taking soundproofing measures.
- This unit cannot be installed in the outdoors. Install indoors (Machine room, etc).
- Hold ambient temperature at 0 - 40°C and humidity at 80%RH or less. Heat rejection from the casing : 0.51 kW / 6 - 8 class / hour, 0.58 kW / 10 - 12 class / hour.
- Connectable to closed type cooling tower only.
 - *1 : In the case of heat pump system, suction gas pipe is not used.
 - *2 : In the case of heat recovery system.
 - *3 : In the case of heat pump system.

*Be sure to refer to the Engineering Data Book for facility design.



RWXYQ-A

Heat Pump
3 class - 6 class
(8 kW) (16 kW)

Easy installation & servicing

Compact and lightweight

The adoption of a new water heat exchanger and optimisation of the refrigerant control circuit has resulted in compact and lightweight design. The unit weight of 90 kg and height of 1,000 mm makes installation easy.

* The unit is designed for indoor installation only.

- Small footprint & lightweight
- Minimal service & installation space required
- Stackable flat top design



Service space (Single installation)

- Service access from the front with minimal space required at rear of the condenser (30 mm)

Note: This is only applicable when drain pipe is connected to the front drain port. Please secure 500 mm rear service space if drain pipe is connected to the rear drain port.

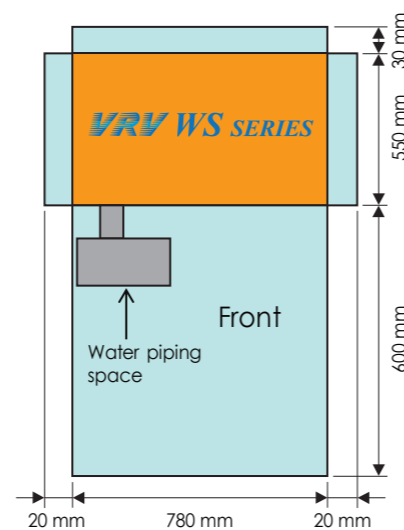

Single phase electric power supply

Single phase power supply enables simplified installation in residential applications.

Energy saving

High Coefficient of Performance (COP)

It has become essential for air conditioning manufacturers to develop systems that provide high energy savings. At Daikin, we have made great efforts for this purpose, **VRV WS series** delivers highly efficient performance, contributing to high energy savings.

COP at 100% operation load

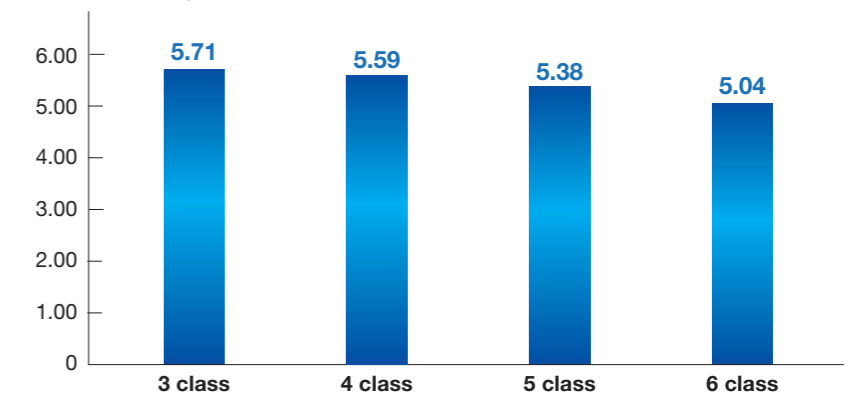

*Cooling : Indoor temp.: 27°CDB, 19°CWB/inlet water temp.: 30°C, Equivalent piping length: 7.5 m, Level difference: 0 m.

Long refrigerant piping length

Within the refrigerant piping system, a maximum of 120 m of actual piping length and 30 m of level difference between the **VRV WS series** and indoor units are possible. Water piping does not enter occupied spaces, so there is little chance of water leaking.

- Actual piping length
Max. 120 m
- Equivalent piping length
Max. 140 m
- Total piping length
Max. 300 m

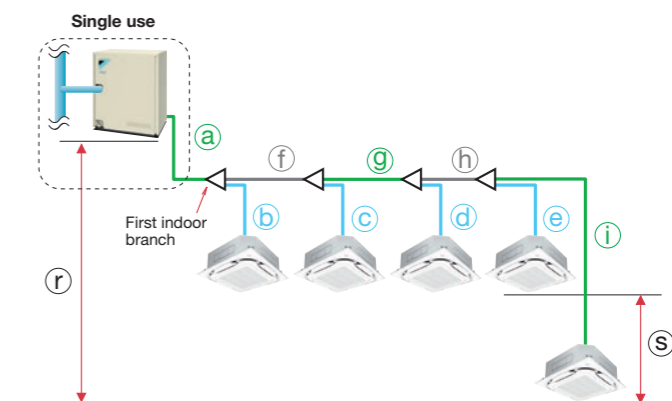

* Colours in the diagram above are merely for identifying pipes referenced with symbols such as @.

	Actual piping length	Example	Equivalent piping length
Max. allowable piping length	Refrigerant piping length	a+f+g+h+i	140 m
	Total piping length	a+b+c+d+e+f+g+h+i	—
	Between the first indoor branch and the farthest indoor unit	f+g+h+i	—
Max. allowable level difference	Between the indoor units	s	—
	Between the outside units and the indoor units	r	—

■ Tube-in-Tube Type Heat Exchanger

The Tube-in-Tube type heat exchanger with refrigerant lines spiraling around the water circuit in a counter flow design delivers superior heat exchange. While the inner groove structure of the water circuit lowers risk of blockage and delivers optimal performance.

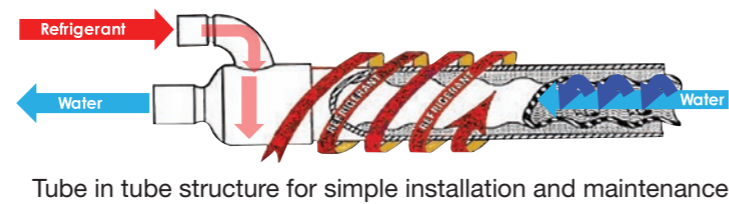

Use of copper pipes enhances tolerance against corrosive effects of chloride ions

■ Refrigerant cooling technology

By introducing refrigerant cooling for VRV WS's inverter power module, heat rejected from the unit to machine room can be significantly reduced. This also helps to keep the unit operation stable even at high ambient temperature and reduces PCB failure ratio.

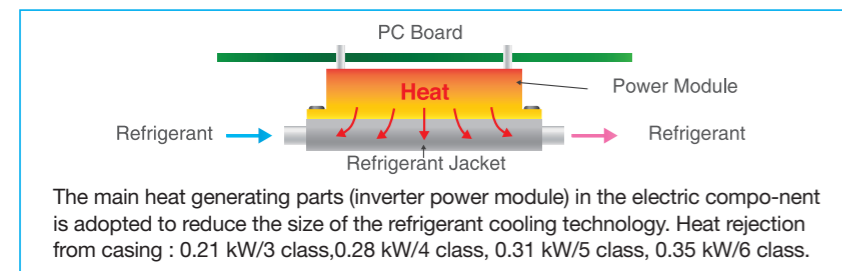

■ Easy maintenance

The electrical components are strategically located at the front which eases the maintenance process. Moreover, the major components are also designed in a way that they can be accessed from front for maintenance.



■ Built in water flow switch

Mechanical water flow switch is built into the system to enhance system reliability.

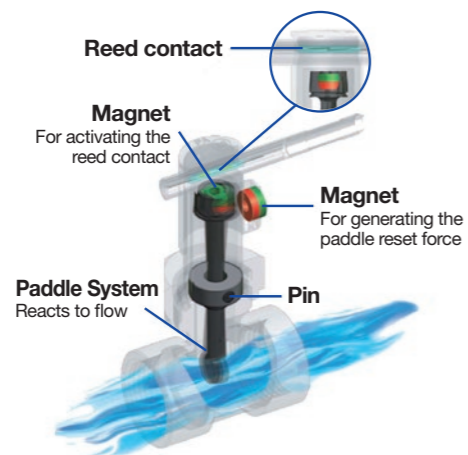

■ Standard water strainer

A standard water strainer is provided together with the unit as an accessory item. This reduces the additional cost and installation time at field. A standard water reduces installation time.



■ Enhanced range of choices

● New lineup

Type	Model Name	Capacity Range(kW)	20	25	32	40	50	63	71	80	100	125	140	145	160	180
			Capacity Index	20	25	31.25	40	50	62.5	71	80	100	125	140	145	160
Ceiling Mounted Cassette (Round Flow with Sensing)	FXFSQ-AVM			●	●	●	●	●			●	●	●			
Ceiling Mounted Cassette (Round Flow)	FXFQ-PVE			●	●	●	●	●			●	●	●			
Ceiling Mounted Cassette (Compact Multi Flow)	FXZQ-A2VEB		●	●	●	●	●									
4-Way Flow Ceiling Suspended	FXUQ-AVEB								●		●					
Ceiling Mounted Cassette (Double Flow)	New FXCQ-AVM		●	●	●	●	●	●		●		●				
Ceiling Mounted Cassette (Single Flow)	FXEQ-AV36		●	●	●	●	●	●								
Slim Ceiling Mounted Duct (Compact Series)	FXDQ-TV1B(A)		●	●	●	●	●	●								
	FXDQ-PDVE		●	●	●											
Slim Ceiling Mounted Duct (Standard Series)	FXDQ-NDVE					●	●	●								
	FXDYQ-MAV1										●	●	●		●	
Middle Static Pressure Ceiling Mounted Duct	FXSQ-PAVE		●	●	●	●	●	●		●	●	●	●			
Ceiling Mounted Duct	FXMQ-PAVE		●	●	●	●	●	●		●	●	●	●			
	FXMQ-PV1A														●	●
Ceiling Suspended	FXHQ-MAVE				●			●			●					
	New FXHQ-AVM											●	●			
Wall Mounted	New FXAQ-AVM		●	●	●	●	●	●								
Floor Standing	FXLQ-MAVE		●	●	●	●	●	●								
Concealed Floor Standing	FXNQ-MAVE		●	●	●	●	●	●								

VRV WS Series Outside Units

RWXYQ-A

Heat Pump

MODEL		RWXYQ3AV1	RWXYQ4AV1	RWXYQ5AV1	RWXYQ6AV1	
Power supply		1-Phase, 220-240 V, 50 Hz				
Cooling capacity	Btu/h	27,300	38,200	47,800	54,600	
	kW	8.0	11.2	14.0	16.0	
Heating capacity	Btu/h	30,700	42,700	54,600	61,400	
	kW	9.0	12.5	16.0	18.0	
Power consumption	Cooling	kW	1.40	2.00	2.60	3.17
	Heating	kW	1.60	2.10	2.60	2.80
Casing colour		Ivory white (5Y7.5/1)				
Dimensions (HxWxD)		mm 1,000x780x550				
Compressor	Type	Hermetically sealed swing type				
	Motor output	kW 1.92				
Refrigerant piping connections	Liquid	mm ϕ 9.5 (Flare)				
	Suction gas	mm ϕ 15.9 (Flare)				
Water piping connections	Water inlet	PT1B external thread		PT1 1/4B external thread		
	Water outlet	PT1B external thread		PT1 1/4B external thread		
	Drain outlet	PS1/2B internal thread				
Machine weight	kg	90	94	99		
Sound level	dB(A)	48	50	68		
Sound power	dB(A)	66	68			
Operation range (Inlet water temp.)	°C	15 to 45 (Range for continuous operation)				
Capacity control	%	20-100				
Refrigerant	Type	R-410A				
	Charge	kg	2.2	2.4	2.7	
Rated water flow (Range of water flow)	L/min	30 (15 to 45)	40 (20 to 60)	50 (25 to 75)	57 (28.5 to 85.5)	

Note :1. Specifications are based on the following conditions ;
 · Cooling : Indoor temp. : 27°CDB, 19°CWB / inlet water temp. :30°C, Equivalent piping length : 7.5 m, Level difference : 0 m.
 · Heating : Indoor temp. : 20°CDB / inlet water temp. : 20°C, Equivalent piping length : 7.5 m, Level difference : 0 m.
 · Sound level: Anechoic chamber conversion value, measured at a point 1 m in front of the unit at a height of 1.5 m.
 During actual operation, these values are normally somewhat higher as a result of ambient conditions and oil recovery mode.
 When there is concern for noise to the surrounding area such as residences, we recommend investigating the installation location and taking soundproofing measures.
 2. This unit cannot be installed in the outdoors. Install indoors (Machine room, etc).
 3. Hold ambient temperature at 0-40°C and humidity at 80% RH or less.
 Heat rejection from the casing: 0.21 kW/3 class /hour, 0.28 kW/4 class /hour, 0.31 kW/5 class /hour, 0.35 kW/6 class /hour

Outside Unit Combinations

Model name	kW	class	Capacity index	Total capacity index of connectable indoor units			Maximum number of connectable indoor units
				Combination (%)			
				50%	100%	130%	
RWXYQ3A	8.0	3	75	37.5	75	97.5	4
RWXYQ4A	11.2	4	100	50	100	130	6
RWXYQ5A	14.0	5	125	62.5	125	162.5	8
RWXYQ6A	16.0	6	150	75	150	195	9

Note: Total capacity index of connectable indoor units must be 50%–130% of the capacity index of the outside unit.

Indoor Unit Lineup

Daikin offers a wide range of indoor units includes both **VRV** and residential models responding to variety of needs of our customers that require air-conditioning solutions.

VRV indoor units

Ceiling Mounted Cassette (Round Flow with Sensing) Type **P.113**

FXFSQ-AVM



Presence of people and floor temperature can be detected to provide comfort and energy savings.



Ceiling Mounted Cassette (Round Flow) Type **P.123**

FXFQ-PVE



360° airflow improves temperature distribution and offers a comfortable living environment



Ceiling Mounted Cassette (Compact Multi Flow) Type **P.125**

FXZQ-A2VEB

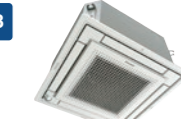

Quiet, compact, and designed for user comfort

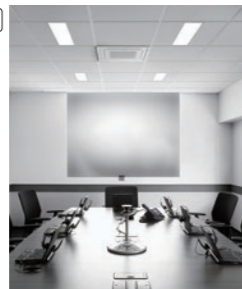

4-Way Flow Ceiling Suspended Type **P.126**

FXUQ-AVEB



This slim and stylish indoor unit achieves optimum air distribution, and can be installed without the need for ceiling cavity



Ceiling Mounted Cassette (Double Flow) Type **P.127**

New **FXCQ-AVM**



Thin, lightweight, and easy to install in narrow ceiling spaces



Ceiling Mounted Cassette (Single Flow) Type **P.129**

FXEQ-AV36



Slim design for flexible installation



Slim Ceiling Mounted Duct Type (Compact Series) **P.131**

FXDQ-TV1B(A)



Slim and compact design for easy and flexible installation



Slim Ceiling Mounted Duct Type (Standard Series) **P.133**

FXDQ-PDVE



Slim design, quietness and static pressure switching



Ceiling Concealed (Duct) Type **P.134**

FXDYQ-MAV1



High static pressure offers flexible duct design that blends in with any interior décor in stores and offices



Middle Static Pressure Ceiling Mounted Duct Type **P.135**

FXSQ-PAVE



Middle static pressure and slim design allow flexible installations



Ceiling Mounted Duct Type **P.137**

FXMQ-PAVE



FXMQ-PV1A



Middle and high static pressure allows flexible installations

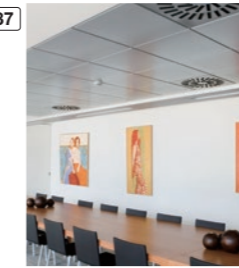

Outdoor-Air Processing Unit **P.161**

FXMQ-MFV1

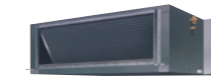

Combine fresh air treatment and air conditioning, supplied from a single system.

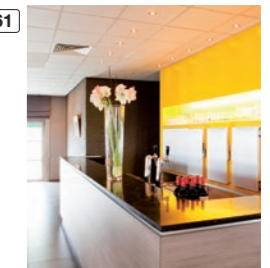

Ceiling Suspended Type **P.139**

FXHQ-MAVE



New **FXHQ-AVM**



Slim body with quiet and wide airflow.



Wall Mounted Type **P.141**

New **FXAQ-AVM**



Stylish flat panel design harmonised with your interior décor.

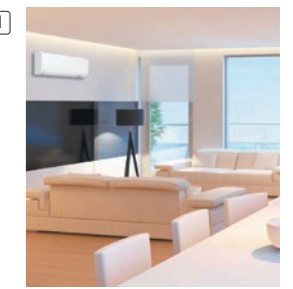

Floor Standing Type **P.143**

FXLQ-MAVE



Suitable for perimeter zone air conditioning

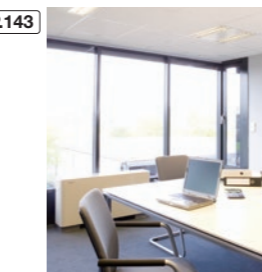

Concealed Floor Standing Type **P.144**

FXNQ-MAVE



Designed to be concealed in the perimeter skirting-wall

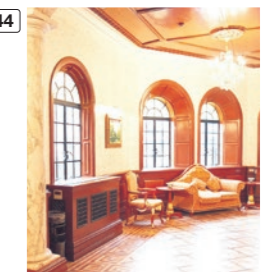

Residential indoor units with connection to BP units

Ceiling Mounted Cassette (Compact Multi Flow) Type **P.145**

FFQ-BV1B



Quiet, compact, and designed for user comfort

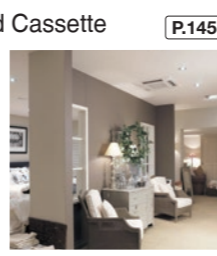

Slim Ceiling Mounted Duct Type **P.147**

FDXS-CVMA



Slim and smooth design suits your shallow ceiling



Wall Mounted Type **P.148**

FTXS-KVMA



FTXS-KAVMA



Stylish flat panel harmonises with your interior décor

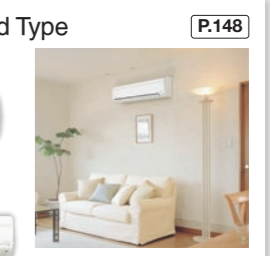

Air treatment equipment

Heat Reclaim Ventilator with DX-Coil and Humidifier **P.159**

VKM-GA(M)V1

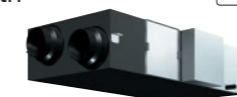

Heat Reclaim Ventilator **P.163**

VAM-GJVE





Ceiling Mounted Cassette (Round Flow with Sensing) Type

FXFSQ-A

**Round flow
with sensing**



Panel variations (Option)



Standard panel with sensing
BYCQ125EEF (Fresh White)

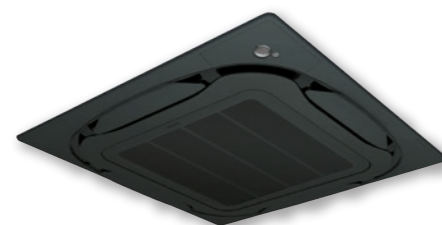

Standard panel with sensing
BYCQ125EEK (Black)



- Fresh White -



- Black -

Specifications

Ceiling Mounted Cassette (Round Flow with Sensing) Type

MODEL		FXFSQ25AVM	FXFSQ32AVM	FXFSQ40AVM	FXFSQ50AVM	FXFSQ63AVM	FXFSQ80AVM	FXFSQ100AVM	FXFSQ125AVM	FXFSQ140AVM
Power supply		1-phase, 220-240 V/220-230 V, 50/60 Hz								
Cooling capacity	Btu/h	9,600	12,300	15,400	19,100	24,200	30,700	38,200	47,800	54,600
	kW	2.8	3.6	4.5	5.6	7.1	9.0	11.2	14.0	16.0
Heating capacity	Btu/h	10,900	13,600	17,100	21,500	27,300	34,100	42,700	54,600	
	kW	3.2	4.0	5.0	6.3	8.0	10.0	12.5	16.0	
Power consumption	Cooling	0.028		0.035	0.056	0.061	0.092	0.164	0.170	0.194
	Heating	0.026		0.034	0.056	0.060	0.092	0.144	0.159	0.183
Casing		Galvanised steel plate								
Airflow rate (H/HM/M/ML/L)	l/s	217/208/192/183/167		283/225/208/200/183	383/342/317/242/183	392/350/333/267/225	408/367/342/333/250	558/508/450/392/350	575/525/475/425/383	592/542/492/442/383
	m ³ /min	13/12.5/11.5/11/10		17/13.5/12.5/12/11	23/20.5/19/14.5/11	23.5/21/20/16/13.5	24.5/22/20.5/20/15	33.5/30.5/27/23.5/21	34.5/31.5/28.5/25.5/23	35.5/32.5/29.5/26.5/23
Sound level (H/HM/M/ML/L)	dB(A)	30/29.5/28.5/28/27		35/29.5/29/28/27	38/35/34.5/29.5/27	38/36/35.5/31.5/28	39/37/36/35.5/31	44/41/38/35/33	45/42.5/39.5/37/35	46/43.5/40.5/38/35
	mm	256x840x840				298x840x840				
Machine weight	kg	19		24	22		25		26	
Piping connections	Liquid (Flare)	φ 6.4				φ 9.5				
	Gas (Flare)	φ 12.7				φ 15.9				
	Drain	VP25 (External Dia. 32/Internal Dia. 25)								

Note: Specifications are based on the following conditions:

- Cooling: Indoor temp.: 27°CDB, 19°CWB, Outdoor temp.: 35°CDB, Equivalent piping length: 7.5 m, Level difference: 0 m.
- Heating: Indoor temp.: 20°CDB, Outdoor temp.: 7°CDB, 6°CWB, Equivalent piping length: 7.5 m, Level difference: 0 m.
- Capacity of indoor unit is only for reference. Actual capacity of indoor unit is based on the total capacity index. (See Engineering Data Book for details.)
- Sound level: Anechoic chamber conversion value, measured at a point 1.5 m downward from the unit centre. During actual operation, these values are normally somewhat higher as a result of ambient conditions.

Decoration Panel (Option)

Standard panel with sensing	Model	BYCQ125EEF (Fresh White) / BYCQ125EEK (Black)
	Dimensions(HxWxD)	mm 50x950x950
	Weight	kg 5.5

Function List

Remote controller	Wired	BRC1E63	—
	Wireless	—	BRC7M634F(K)
Dual sensors		○	
Direct airflow		○	
Sensing sensor low mode		○	
Sensing sensor stop mode		○	
Circulation airflow		○	
Individual airflow direction control		○	
Switchable 5 step fan speed		○	○
Auto airflow rate		○	○
Auto swing		○	○
Swing pattern selection		○	○
High ceiling application		○	



Ceiling Mounted Cassette (Round Flow with Sensing) Type

FXFSQ-A

Daikin Advanced Sensing Functions*1

Dual sensors*1

*1. Applicable when wired remote controller BRC1E63 is used.

Dual sensors and individual airflow direction control automatically provide optimal control of airflow.

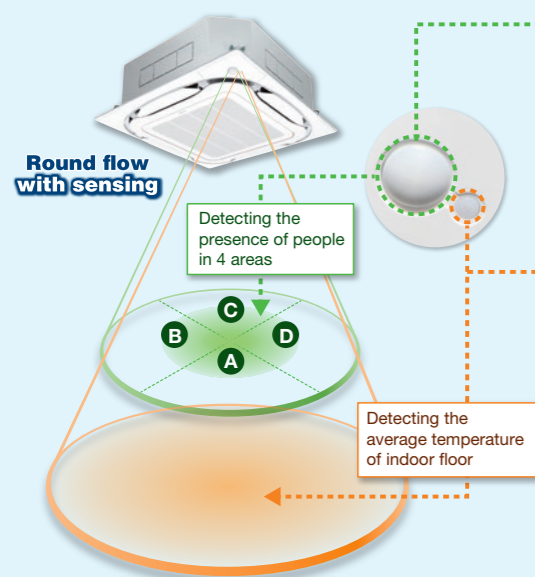

Infrared presence sensor

The 4 sensors detect human presence.

Ceiling height	2.7m	3.5m	4.0m
Detection range (diameter)*2	approx. 8.5m	approx. 11.5m	approx. 13.5m

*2. The infrared presence sensor detects 80 cm above the floor.

Infrared floor sensor

The sensor detects the floor temperature and automatically adjusts operation of the indoor unit to reduce the temperature difference between the ceiling and the floor.

Ceiling height	2.7m	3.5m	4.0m
Detection range (diameter)*3	approx. 11m	approx. 14m	approx. 16m

*3. The infrared floor sensor detects at the floor surface.

Sensing sensor functions*4*5

Sensing sensor low mode (default: OFF)

When there are no people in a room, the set temperature is shifted automatically.

The system automatically saves energy by detecting whether or not the room is occupied. The set temperature is shifted automatically if the room is unoccupied.

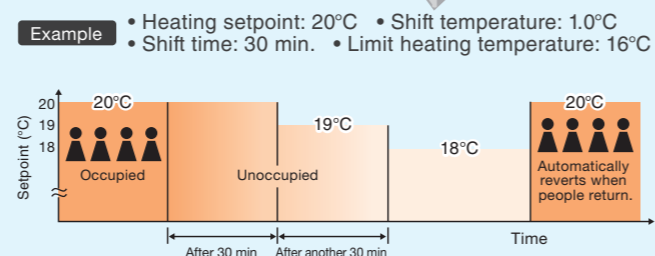
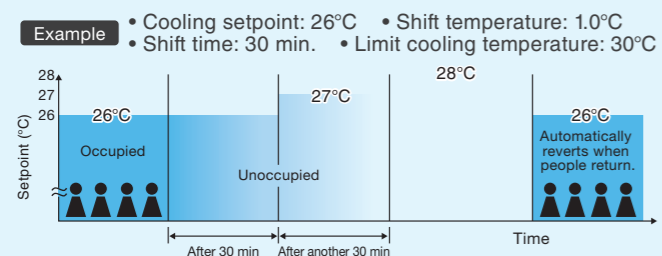

If people do not return, the air conditioner will raise the temperature 1°C every 30 minutes and then operate at 30°C.

If people do not return, the air conditioner will lower the temperature 1°C every 30 minutes and then operate at 16°C.

Shift temperature and time can be selected from 0.5 to 4°C in 0.5°C increments and 15, 30, 45, 60, 90 or 120 minutes respectively with remote controller.

Sensing sensor stop mode (default: OFF)

When there are no people in a room, the system stops automatically.*6*7

The system automatically saves energy by detecting whether or not the room is occupied. Based on preset user conditions, the system automatically stops operation if the room is unoccupied.

Absent stop time can be selected from 1 to 24 hrs in 1 hr increments with remote controller.

*4. These functions are not available when using the group control system.

*5. User can set these functions with remote controller.

*6. Please note that upon re-entering the room, air conditioner will not switch on automatically.

*7. To protect the machine, the standby system may operate temporarily.

Operation is reduced in places where there are no people.

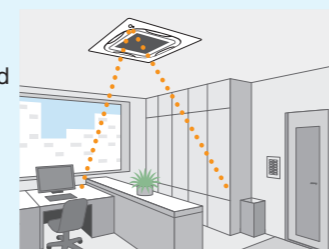
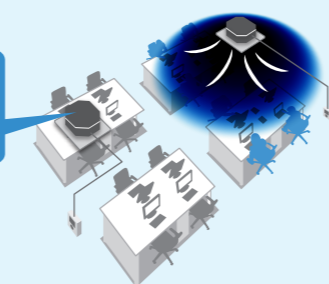

Auto airflow function*8

*8. Airflow direction should be set to "Auto".

Direct Airflow (default: OFF) Cooling Dry

When human presence not detected.

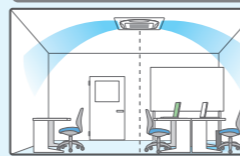

Optimal air direction by "Auto"

When human presence detected.

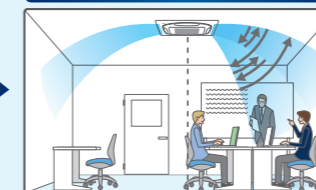

Optimal air direction by "Auto" Swing (narrow)

• With Auto airflow direction mode, flaps are controlled to deliver optimal airflow when the room is unoccupied.

• When human is detected, air direction is set to "Swing (narrow)" to deliver cool air to users.

Draft prevention function (default: OFF) Heating

When human presence not detected.

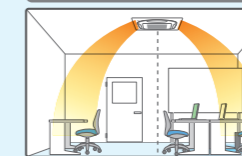

Blown downward

When human presence detected.

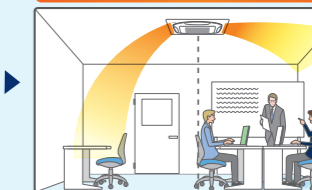

Blown downward Blown horizontally

• With Auto airflow direction mode, flaps are controlled to deliver optimal airflow when the room is unoccupied.

• When human is detected, drafts are prevented by making the flap horizontal.

• When human is not detected for 5 minutes, the unit automatically returns to controlling the flaps for an unoccupied room.

Comfort and energy saving preventing over cooling/heating*9

*9. Airflow direction and airflow rate should be set to "Auto".

Floor temperature is detected and over cooling prevented. Cooling

Without sensing function

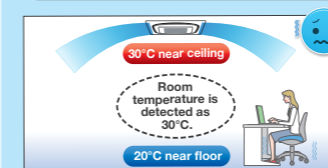

Area around feet gets too cold because air conditioner continues until the temperature near the ceiling reaches the set temperature.

With sensing function

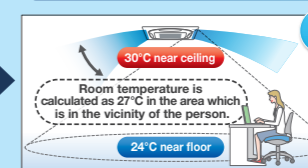

The floor temperature, which is lower than near the ceiling, is detected.

Automatic control using the temperature near the person as the room temperature.

Energy savings

The temperature near the person is automatically calculated by detecting the temperature of the floor. Energy is saved, because the area around the feet does not get too cold.

Feet are kept warm and comfortable while reducing uncomfortable drafts. Heating

Without sensing function



Feet get cold, because warm air collects near the ceiling. Area near floor doesn't reach set temperature and feet feel cold. For this reason, we end up raising the temperature setting.

With sensing function

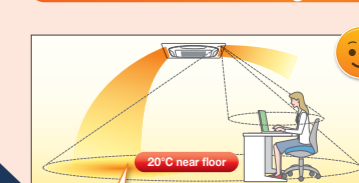

In order to reduce drafts, air is blown horizontally where a person is located.*10



Uncomfortable draft occurs, because air is blown downward. To avoid draft, air direction is changed to horizontal and feet get cold.

The floor temperature, which is lower, is detected and warm air is blown downward where no person is present.

Comfortable because draft is reduced and area around feet is warm.

Energy savings

The tendency of people to raise the temperature too much is prevented, because you are warmed up from the feet.

To increase comfort, Auto airflow rate mode controls the airflow in accordance with the difference between floor and ceiling temperatures. When there is a large difference between the ceiling and floor temperatures, the airflow rate is automatically increased. When the difference becomes small, the airflow rate is automatically reduced.

*10. Draft prevention function is set OFF in the initial setting.

Ceiling Mounted Cassette (Round Flow with Sensing) Type

FXFSQ-A

Circulation Airflow^{*1,2}

*1. Applicable when wired remote controller BRC1E63 is used.
*2. Not applicable when using individual airflow direction control.

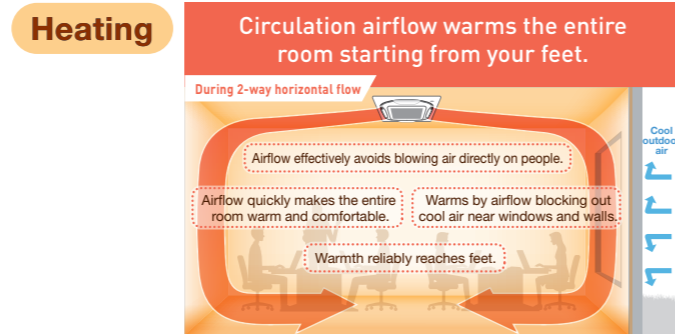
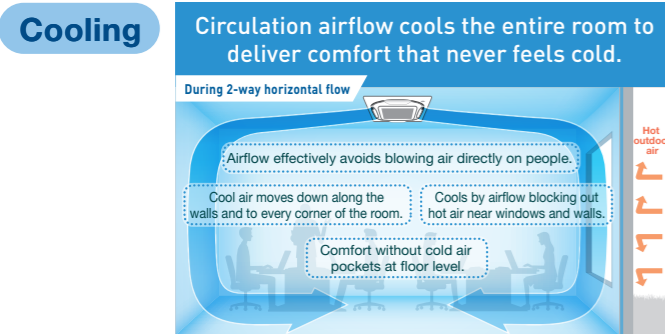

Cooling Heating Comfort to the entire room with even temperatures and no cold air pockets at floor level

Cooling

4-way cassette (Swing)

Comparison Conditions

- Room size: Width 7.5m x depth 7.5m x height 2.6m
- Indoor unit capacity: 71 class
- Outdoor air temperature: 35°C
- Airflow rate and air direction: high / swing

Areas at floor level are cold while areas around walls are hot.

Circulation Airflow (2-way horizontal + 4-way swing)

Approx. 5% energy savings^{*3} by reducing uneven temperatures

*3. Calculated under the following comparison conditions: When the average temperature at a height of 0.6m above the floor reaches set temperature. (26°C)

Full comfort is provided with no cold feet.

Heating

4-way cassette (Down blow)

Comparison Conditions

- Room size: Width 7.5m x depth 7.5m x height 2.6m
- Indoor unit capacity: 71 class
- Outdoor air temperature: 5°C
- Airflow rate and air direction: high / Down blow

Areas around walls and feet are cold.

Circulation Airflow (2-way horizontal + 4-way swing)

Approx. 15% energy savings^{*4} by reducing uneven temperatures

*4. Calculated under the following comparison conditions: When the average temperature at a height of 0.6m above the floor reaches set temperature. (22°C)

Areas around walls and feet are warm.

Configurations of Circulation Airflow

Note: Results may vary depending on equipment conditions, room size, and distance from indoor unit to walls.

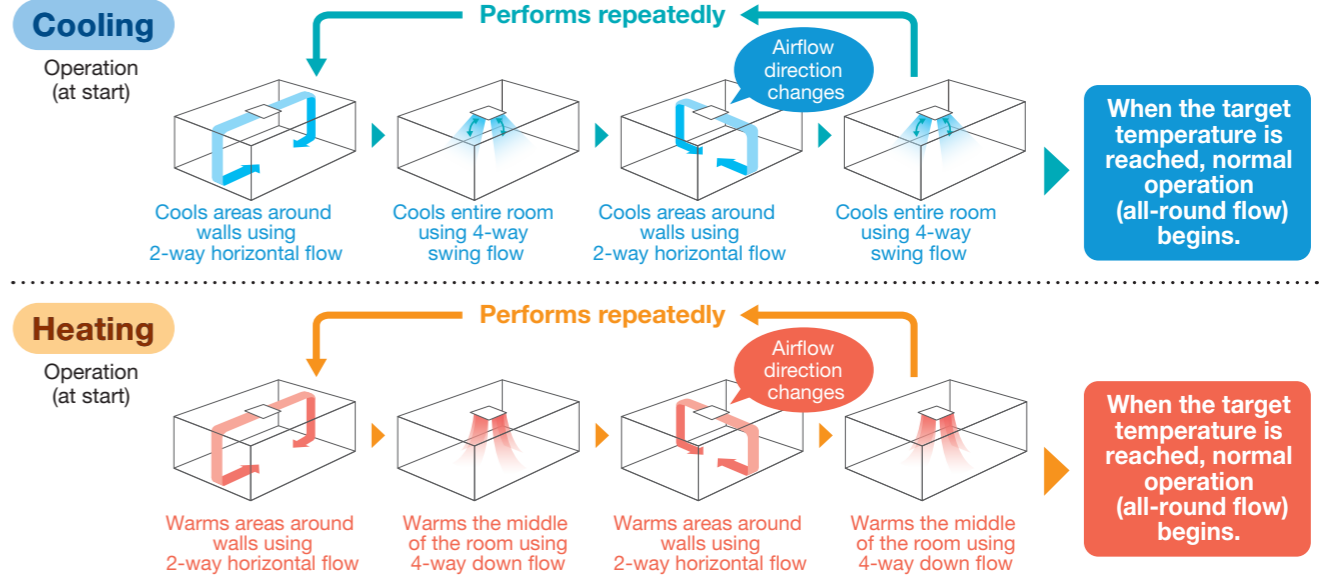

Three Technologies That Achieved Circulation Airflow

1 Use of new wide flaps (Straight)

With new, larger flaps, a straighter trajectory for airflow was achieved.

Conventional flap^{*5}

New wide flap

Approx. doubled

*5. FXFQ-S model

New wide flap construction inhibits ceiling dirt and grime. By tapering both flap ends, the airflow that causes dirty ceilings is directed downward.

2 Optimizing airflow angle (Horizontally)

The airflow angle was made more horizontal.

Conventional flap^{*5}

*5. FXFQ-S model

30° air direction

Cannot blow more than 30° horizontal.

When set to 20° the airflow route gets narrow.

New wide flap

20° horizontal flow

20° air direction

Even at 20°, the airflow route is sufficiently maintained.

A more horizontal 20° flow is realized.

Velocity 10% increase!

3 Increased velocity in 2-way flow (Strongly)

Velocity increased by making 2-way flow. Powerful airflow was realized.

All-round flow

Two-way flow

*6. Other 2 outlets are controlled by changing the flap direction (angle) to suppress airflow volume.

Things to remember when using circulation airflow

Main points for use

- Effectiveness may differ according to room conditions, room size, and distance to walls.
- Circulation airflow functions during connection with wired remote controller (BRC1E63). However, use is not possible for the following conditions:
 - When a sealing material of air discharge outlet and branch ducts are used;
 - When individual airflow setting is selected;
 - When using group control other than round flow.

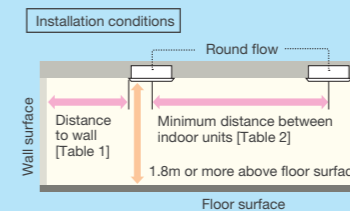

[Table 1] Distance to wall from indoor unit

Indoor unit capacity	FXFSQ 25-50	FXFSQ 63/80	FXFSQ 100-140
Distance range	1.5m-4m	1.5m-5m	1.5m-7m

[Table 2] Minimum distance between indoor units

Indoor unit capacity	FXFSQ 25-50	FXFSQ 63/80	FXFSQ 100-140
Minimum distance	4m or more	5m or more	7m or more

Ceiling Mounted Cassette (Round Flow with Sensing) Type

FXFSQ-A

Individual Airflow Direction Control^{*1}

^{*1} Applicable when wired remote controller BRC1E63 is used.

Comfortable air conditioning for all room layouts and conditions

Airflow direction can be individually adjusted for each air discharge outlet to deliver optimal air distribution.

Easy setting is possible with a wired remote controller "Nav Ease".

Position 0
(Fixed airflow to highest position)

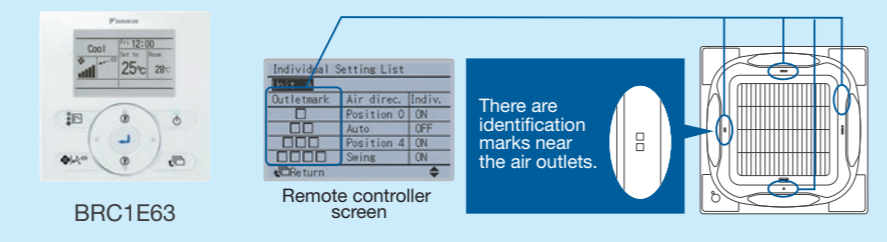
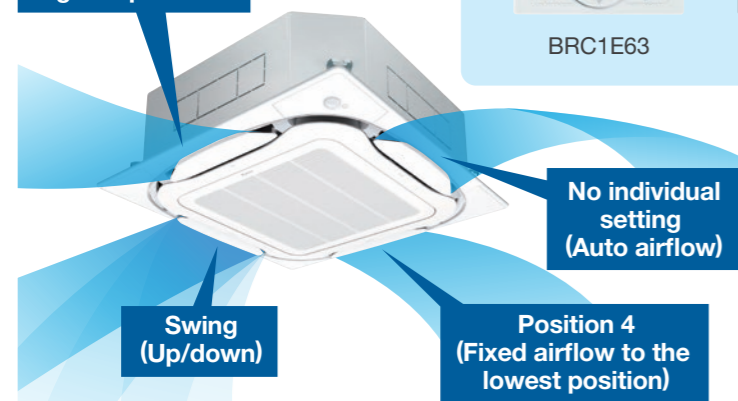

There are identification marks near the air outlets.

- #### Individual airflow settings
- No individual setting (Auto airflow)
 - Position 0 (Highest point)
 - Position 1
 - Position 2
 - Position 3
 - Position 4 (Lowest point)
 - Swing

Individual settings are possible as stated above.

When individual airflow is selected, airflow direction can be adjusted to room layout.

For offices

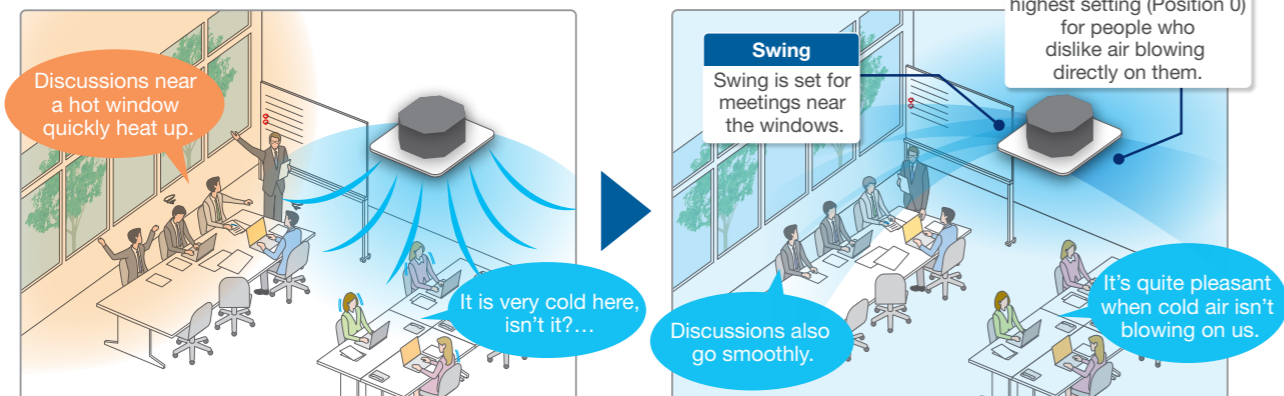

For shops and restaurant

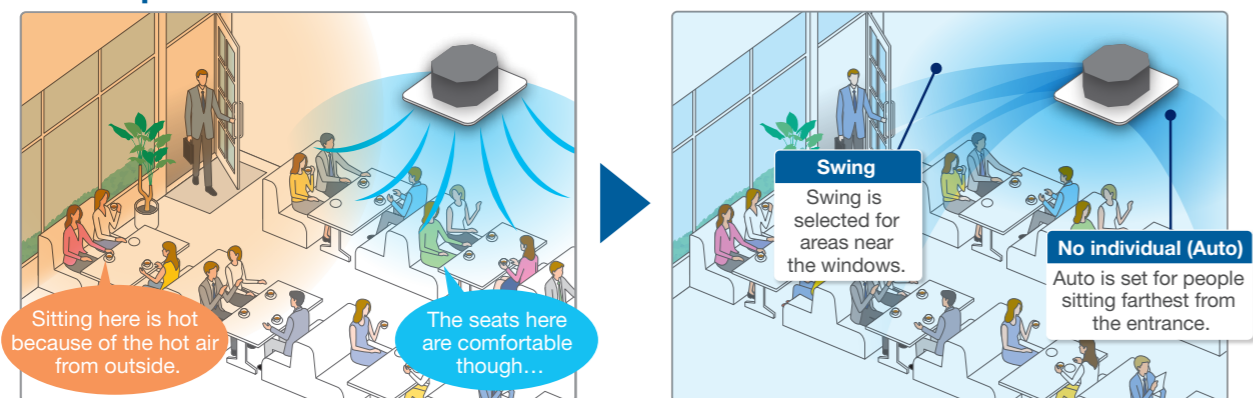

Other Functions

Comfort

360° Airflow & Selectable Airflow Pattern

Indoor unit offers 360° airflow discharges air in all directions with more uniform temperature distribution. Because air flows out from corner outlets, comfort spreads more widely.

Typical flow patterns There are a total of 18 flow patterns.

All-round flow

(E.g., installed in middle of ceiling)
4-way flow also possible.

3-way flow

(E.g., installed near a wall)

L-shaped 2-way flow

(E.g., installed in a corner)

Opposite 2-way flow

(E.g., installed in a long room)

Required distance to wall surface for closing air discharge outlet

Minimum distance of 500mm
* 200mm for corner closing

Note:
- Whatever the discharge direction, the same type of panel is used. If installing for other than all-round flow, an air discharge outlet sealing material (option) must be used to close each unused outlet.
- Operation sound increases when using 2-way or 3-way flow.

Optimal comfort and convenience assured by 3 air discharge modes

Air direction	Standard setting ¹	Draft prevention setting (field setting)	Ceiling soiling prevention setting ² (field setting)
Desired situation	For gentle drafts.	When drafts are unwanted.	For shops with light coloured ceilings that must be kept spotless.
Auto-swing			
5-level air direction setting			
Auto air direction control	The air direction is set automatically to the memorised position of the previous air direction.		

Note:
¹ Air direction is set to the standard position when the unit is shipped from the factory. The position can be changed from the remote controller.
² Closing of the corner discharge outlets is recommended.

Switchable fan speed: 5 steps and Auto

Control of airflow rate has been improved from 3-step to 5-step. Auto airflow rate is newly available.

Suitable for high ceilings

Even in spaces with high ceilings, a comfortable airflow is carried down to the floor level.

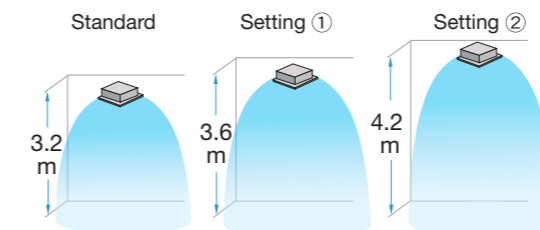

When all round flow is selected, ceilings up to 4.2 m in height can be accommodated. (FXFSQ100-140A)

Criteria for ceiling height and number of air discharge outlets (Ceiling height is reference value)

Ceiling height		Number of air discharge outlets used							
		FXFSQ25-80A				FXFSQ100-140A			
		All round flow	4-way flow	3-way flow	2-way flow	All round flow	4-way flow	3-way flow	2-way flow
Standard	2.7 m	3.1 m	3.0 m	3.5 m	3.2 m	3.4 m	3.6 m	4.2 m	
High ceiling ①	3.0 m	3.4 m	3.3 m	3.8 m	3.6 m	3.9 m	4.0 m	4.2 m	
High ceiling ②	3.5 m	4.0 m	3.5 m	—	4.2 m	4.5 m	4.2 m	—	

Note:
• Factory settings are for standard ceiling height and all-round flow.
• High ceiling settings (1) and (2) are set with the remote controller by field setting.
• High-efficiency filters are not available for high ceiling applications.

Ceiling Mounted Cassette (Round Flow with Sensing) Type

FXFSQ-A

Quick and Easy Installation

Lightweight

All models can be installed without using a lifter.

Installable in tight ceiling spaces

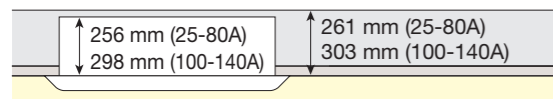

Easy removal of corner cover

It is possible to easily remove without use of screws or tools.



Easy height adjustment

Each corner of the unit has an adjuster pocket that lets you easily adjust the unit's suspended height.

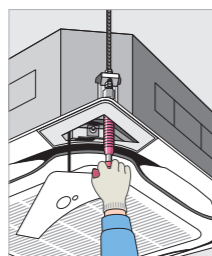

Note:
If the wireless remote controller is installed, a signal receiver unit is housed in one of the adjuster pockets.

Temporary placement of control box lid

Because the control box lid can be temporarily hung on the unit, there is no need to climb down the stepladder to retrieve it.

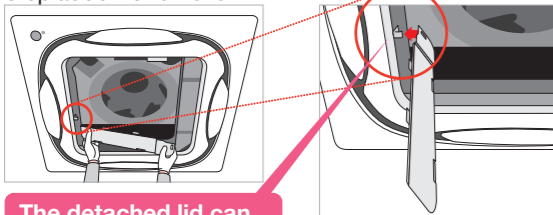

The detached lid can be hung on a hook.

Installed in any direction

Since the orientation of the suction grille can be adjusted after installing, the direction of the suction grille lines can be unified when multiple units are installed.

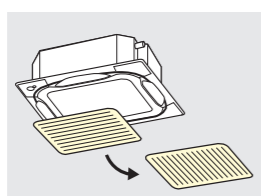

Easy hanging

Washer fixing plates secure washers in place and prevent washers from falling for easy installation.



Ease in temporary hanging of decoration panel

In addition to the temporary hanging fixtures in 2 places normally used, corner part mounting fixtures in 4 places are provided.

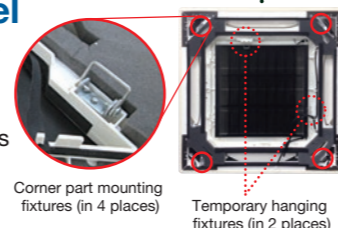

Drain pump

Equipped as standard accessory with 850 mm lift.

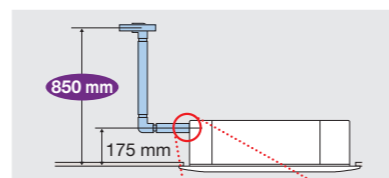

Transparent drain socket



Hanging height adjustment

Because the configuration of the hanger bracket changed, the dimensions from the ceiling to the hanger bracket also change during height adjustment for indoor unit.

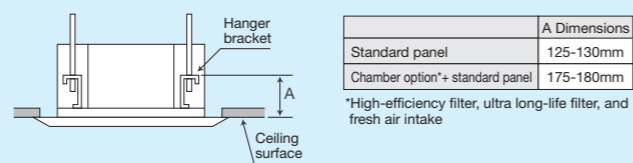

	A Dimensions
Standard panel	125-130mm
Chamber option* + standard panel	175-180mm

*High-efficiency filter, ultra long-life filter, and fresh air intake

Easy Maintenance

Drain pan and drain water check

The condition of the drain pan and drain water can be checked by removing the suction grille and drain plug.

Just open the suction grille!

Drain outlet (with rubber plug)

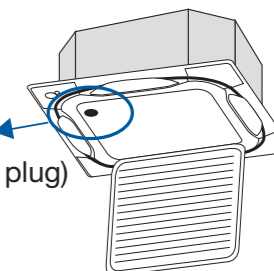

24 mm diameter drain outlet

The drain outlet allows insertion of a finger or dental mirror for inspection of the internal cleanliness of the drain pan. Removal of the suction panel enables access.

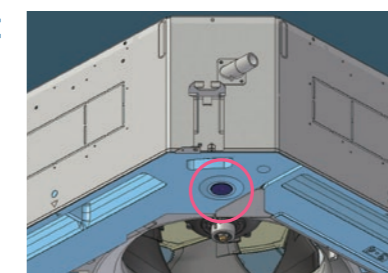

Ultra long-life filter (option)

See page 190

Maintenance is not required in normal shops or offices for up to four years.

Cleanliness

Silver ion anti-bacterial drain pan

A built-in antibacterial treatment that uses silver ion in the drain pan prevents the growth of slime, bacteria, and mould that cause odours and clogging.

(The lifespan of a silver ion cartridge depends on the usage environment, but should be changed once every two to three years.)



Non-flocking flaps

Flaps can be detached without use of tools. Condensation does not easily form and dirt does not cling to non-flocking flaps. They are easy to clean.



Filter has anti-mould and antibacterial treatment

Prevents mould and microorganisms growing out of the dust and moisture that adheres to the filters.

Ceiling Mounted Cassette (Round Flow) Type

FXFQ-P

360° airflow improves temperature distribution and offers a comfortable living environment.



● The industry's first* Round Flow Ceiling Mounted Cassette type offers 360° airflow with improved temperature distribution.

* As of April 2004, the release date for Japan.

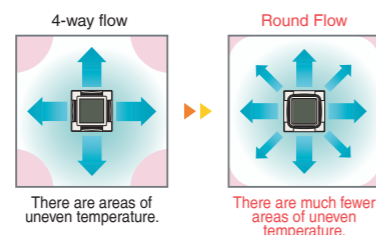

● The light weight unit at 19.5 kg for FXFQ25-50P models makes installation easy.

● Drain pump is equipped as a standard accessory with a 850 mm lift.

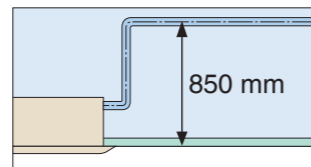

● A modern sophisticated decoration panel has been applied, with a panel surface that has been treated with a dirt-repellant coating.



● Control of the airflow rate can be selected from 3-step control.

● The horizontal louvres prevent dew condensation. Their non-flocking surfaces, which repel dirt, are easy to clean.

● An antibacterial treatment that uses silver ions has been applied to the drain pan, preventing the growth of slime, mould and bacteria that cause blockages and odours.

(The lifespan of a silver ion cartridge depends on the usage environment, but should be changed once every two to three years.)



● The air filter has an anti-mould and antibacterial treatment that prevents the growth of mould generated from dust or moisture that may adhere to the filter.

● Example of airflow patterns:

All-round flow is available, as well as 2-way to 4-way flows, so you can choose the most suitable airflow pattern depending on location or room layout.



Note: Whatever the discharge direction, the same type of panel is used. If installing for other than all-round flow, an air discharge outlet sealing material (option) must be used to close each unused outlet.

Specifications

MODEL		FXFQ25PVE	FXFQ32PVE	FXFQ40PVE	FXFQ50PVE	FXFQ63PVE	FXFQ80PVE	FXFQ100PVE	FXFQ125PVE
Power supply		1-phase, 220-240 V/220 V, 50/60 Hz							
Cooling capacity	Btu/h	9,600	12,300	15,400	19,100	24,200	30,700	38,200	47,800
	kW	2.8	3.6	4.5	5.6	7.1	9.0	11.2	14.0
Heating capacity	Btu/h	10,900	13,600	17,100	21,500	27,300	34,100	42,700	54,600
	kW	3.2	4.0	5.0	6.3	8.0	10.0	12.5	16.0
Power consumption	Cooling kW	0.033		0.047	0.052	0.066	0.093	0.187	0.209
	Heating kW	0.027		0.034	0.038	0.053	0.075	0.174	0.200
Casing		Galvanised steel plate							
Airflow rate (HH/H/L)	l/s	216/191/166		250/216/183	266/225/183	316/275/225	350/300/250	533/433/333	550/466/375
	m³/min	13/11.5/10		15/13/11	16/13.5/11	19/16.5/13.5	21/18/15	32/26/20	33/28/22.5
Sound level (HH/H/L)	dB(A)	30/28.5/27		31/29/27	32/29.5/27	34/31/28	36/33.5/31	43/37.5/32	44/39/34
Sound power (HH/H/L)	dB(A)	48/46.5/45		49/47/45	50/47.5/45	52/49/46	53/51.5/49	60/54.5/50	61/56/52
Dimensions (HxWxD)	mm	246x840x840						288x840x840	
Machine weight	kg	19.5				22		25	
Piping connections	Liquid (Flare)	φ 6.4				φ 9.5			
	Gas (Flare)	φ 12.7				φ 15.9			
	Drain	VP25 (External Dia. 32/Internal Dia. 25)							
Panel (Option)	Model	BYCP125K-W1							
	Colour	Fresh white							
	Dimensions(HxWxD)	50X950X950							
	Weight	5.5							

Note: Specifications are based on the following conditions;

•Cooling: Indoor temp.: 27°CDB, 19°CWB, Outdoor temp.: 35°CDB, Equivalent piping length: 7.5 m, Level difference: 0 m.

•Heating: Indoor temp.: 20°CDB, Outdoor temp.: 7°CDB, 6°CWB, Equivalent piping length: 7.5 m, Level difference: 0 m.

•Capacity of indoor unit is only for reference. Actual capacity of indoor unit is based on the total capacity index. (See Engineering Data Book for details.)

•Sound level: Anechoic chamber conversion value, measured at a point 1.5 m downward from the unit centre.

During actual operation, these values are normally somewhat higher as a result of ambient conditions.

Ceiling Mounted Cassette (Compact Multi Flow) Type FXZQ-A2

Quiet, compact, and designed for user comfort



- The newly designed panel integrates fully within one ceiling tile enabling lights, speakers and sprinklers to be installed in the adjoining ceiling tiles.



- Dimensions correspond with 600 mm X 600 mm architectural module ceiling design specifications.

- Drain pump is equipped as standard accessory with 850 mm lift.

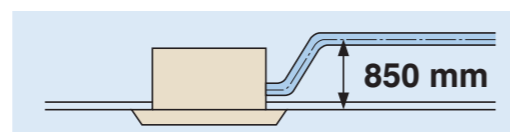

- An optional presence and floor sensor kit (BRYQ60A2W) can be fitted to the cassette for draught prevention, energy saving operation and to avoid temperature stratification during heating.

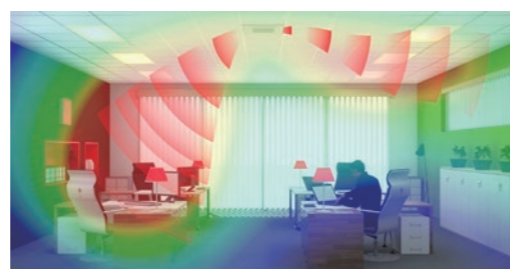

- 2-, 3-, and 4-way airflow patterns are available, enabling installation in the corner of a room.

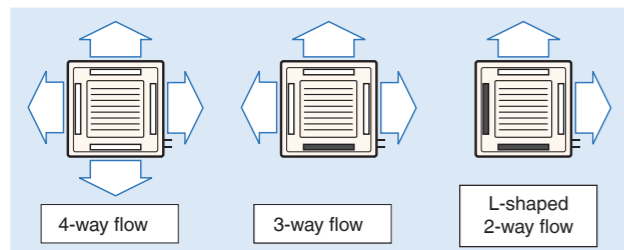

*For 3-way or 2-way flow installation, the sealing material for air discharge outlet (option) must be used to close each unused outlet.

Specifications

MODEL		FXZQ20A2VEB	FXZQ25A2VEB	FXZQ32A2VEB	FXZQ40A2VEB	FXZQ50A2VEB
Power supply		1-phase, 220-240 V/220 V, 50/60 Hz				
Cooling capacity	Btu/h	7,500	9,600	12,300	15,400	19,100
	kW	2.2	2.8	3.6	4.5	5.6
Heating capacity	Btu/h	8,500	10,900	13,600	17,100	21,500
	kW	2.5	3.2	4.0	5.0	6.3
Power consumption	Cooling kW	0.043		0.045	0.059	0.092
	Heating kW	0.036		0.038	0.053	0.086
Casing		Galvanised steel plate				
Airflow rate (H/M/L)	ℓ/s	145/125/108	150/133/108	167/142/117	192/158/133	242/208/167
	m³/min	8.7/7.5/6.5	9/8/6.5	10/8.5/7	11.5/9.5/8	14.5/12.5/10
Sound level (H/M/L)	dB(A)	32/29.5/25.5	33/30/25.5	33.5/30/26	37/32/28	43/40/33
Sound power (H)	dB(A)	49	50	51	54	60
Dimensions (HxWxD)	mm	260x575x575 (For depth add 63mm for electrical box)				
Machine weight	kg	15.5		16.5		18.5
Piping connections	Liquid (Flare)	φ6.4				
	Gas (Flare)	φ12.7				
	Drain	VP20 (External Dia. 26/Internal Dia. 20)				
Panel (Option)	Model	BYFQ60C2W1W				
	Colour	White (N9.5)				
	Dimensions(HxWxD)	46x620x620				
	Weight	2.8				

Note: Specifications are based on the following conditions:
 •Cooling: Indoor temp.: 27°CDB, 19°CWB, Outdoor temp.: 35°CDB, Equivalent piping length: 7.5 m, Level difference: 0 m.
 •Heating: Indoor temp.: 20°CDB, Outdoor temp.: 7°CDB, 6°CWB, Equivalent piping length: 7.5 m, Level difference: 0 m.
 •Capacity of indoor unit is only for reference. Actual capacity of indoor unit is based on the total capacity index. (See Engineering Data Book for details.)
 •Sound level: Anechoic chamber conversion value, measured at a point 1.5 m downward from the unit centre.
 During actual operation, these values are normally somewhat higher as a result of ambient conditions.

4-way Flow Ceiling Suspended Type FXUQ-A

This slim and stylish indoor unit achieves optimum air distribution, and can be installed without the need for ceiling cavity.



- Unit body and suction panel adopted round shapes and realised a slim appearance design. The unit can be used for various locations such as the ceilings with no cavity and bare ceilings.

- Flaps close automatically when the unit stops, which gives a simple appearance.

- Unified slim height of 198 mm for all models that gives the unified impression even when models with different capacities are installed in the same area.

- With adoption of the individual flap control, airflow direction adjustment can be individually set for each air outlet. 5 directions of airflow and auto-swing can be selected with wired remote controller BRC1E63, which realises the optimum air distribution.

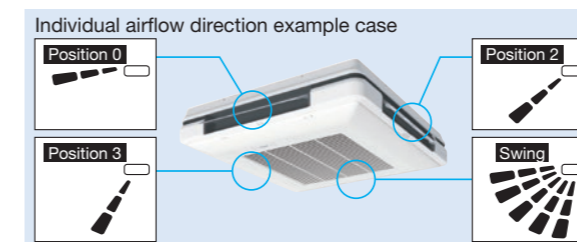

- Control of the airflow rate has been improved from 2-step to 3-step control. Auto airflow rate control can be selected with wired remote controller BRC1E63.

- Built-in electronic expansion valve eliminates the need for a BEV unit, which improves flexibility of installation.

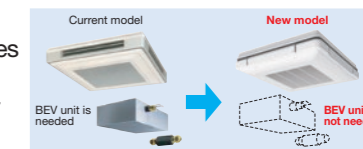

- Energy efficiency has been improved thanks to the adoption of a new heat exchanger with smaller tubes, DC fan motor and DC drain pump motor.

- Drain pump is equipped as a standard accessory, and the lift height has been improved from 500 mm to 600 mm.

- Depending on installation site requirements or room conditions, 2-way, 3-way and 4-way discharge patterns are available.



- An antibacterial treatment that uses silver ions has been applied to the drain pan, preventing the growth of slime, mould and bacteria that cause blockages and odours.

(The lifespan of a silver ion cartridge depends on the usage environment, but should be changed once every two to three years.)



Specifications

MODEL		FXUQ71AVEB	FXUQ100AVEB
Power supply		1-phase, 220-240 V/220-230 V, 50/60 Hz	
Cooling capacity	Btu/h	27,300	38,200
	kW	8.0	11.2
Heating capacity	Btu/h	30,700	42,700
	kW	9.0	12.5
Power consumption	Cooling kW	0.090	0.200
	Heating kW	0.073	0.179
Casing		Fresh white	
Airflow rate (H/M/L)	ℓ/s	375/325/267	517/433/350
	m³/min	22.5/19.5/16	31/26/21
Sound level (H/M/L)	dB(A)	40/38/36	47/44/40
Sound power (H/M/L)	dB(A)	58/56/54	65/62/58
Dimensions (HxWxD)	mm	198x950x950	
Machine weight	kg	26	27
Piping connections	Liquid (Flare)	φ9.5	
	Gas (Flare)	φ15.9	
	Drain	VP20 (External Dia. 26/Internal Dia. 20)	

Note: Specifications are based on the following conditions:
 •Cooling: Indoor temp.: 27°CDB, 19°CWB, Outdoor temp.: 35°CDB, Equivalent piping length: 7.5 m, Level difference: 0 m.
 •Heating: Indoor temp.: 20°CDB, Outdoor temp.: 7°CDB, 6°CWB, Equivalent piping length: 7.5 m, Level difference: 0 m.
 •Capacity of indoor unit is only for reference. Actual capacity of indoor unit is based on the total capacity index. (See Engineering Data Book for details.)
 •Sound level: Anechoic chamber conversion value, measured at a point 1 m in front of the unit and 1 m downward.
 During actual operation, these values are normally somewhat higher as a result of ambient conditions.

Ceiling Mounted Cassette (Double Flow) Type

New **FXCQ-A**

Stylish unit blends easily with any interior. Integrated ceiling surface with sophisticated panel design with the adoption of flat flap.



New panel design

- This model features a stylish flat panel with fresh white colour for a new sophisticated appearance.
- The flat flaps close entirely when the unit is not operating and there are no air intake grilles visible.

Individual Airflow Direction Control ^{*1}

- Airflow direction can be individually adjusted for each air discharge outlet to deliver optimal air distribution.

^{*1}. Applicable when wired remote controller BRC1E63 is used.

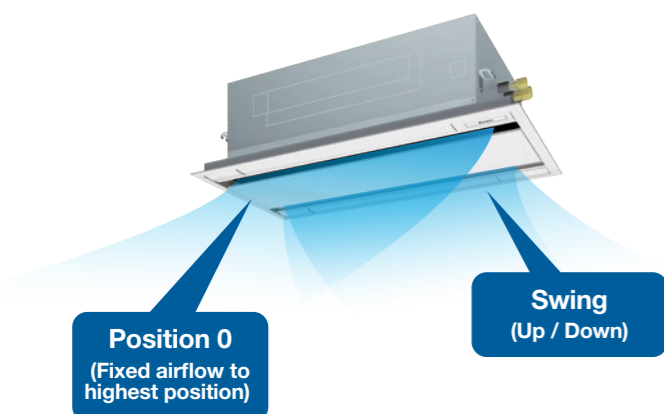

Easy setting is possible with a wired remote controller.

Outletmark	Air direc.	Indiv.
□	Swing	ON
□	Position 0	ON
□	-	-

There are identification marks near the air outlets.

Individual airflow settings	
• No individual setting (Auto airflow)	• Position 0 (Highest point)
• Position 1	• Position 2
• Position 3	• Position 4 (Lowest point)
• Swing	

Individual settings are possible as stated above.

Switchable fan speed: 5 steps and Auto

- Control of airflow rate has been improved from 3-step to 5-step. Auto airflow rate is newly available.

Suitable for high ceilings

- Even in spaces with high ceilings maximum 3.5 m, a comfortable airflow is carried down to the floor level.

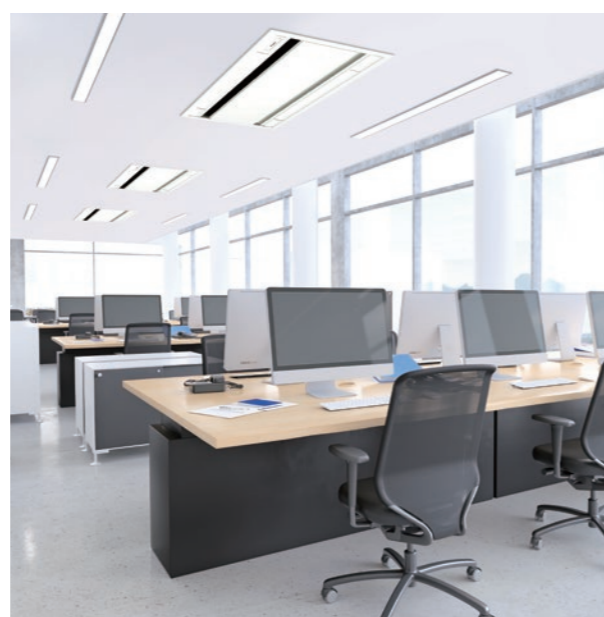
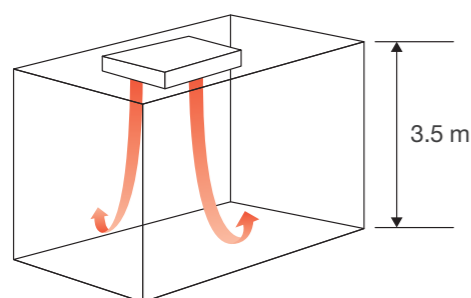

Energy saving : Reduction of energy consumption

- Power consumption is significantly reduced by specially developed small tube heat exchanger and DC fan motor.

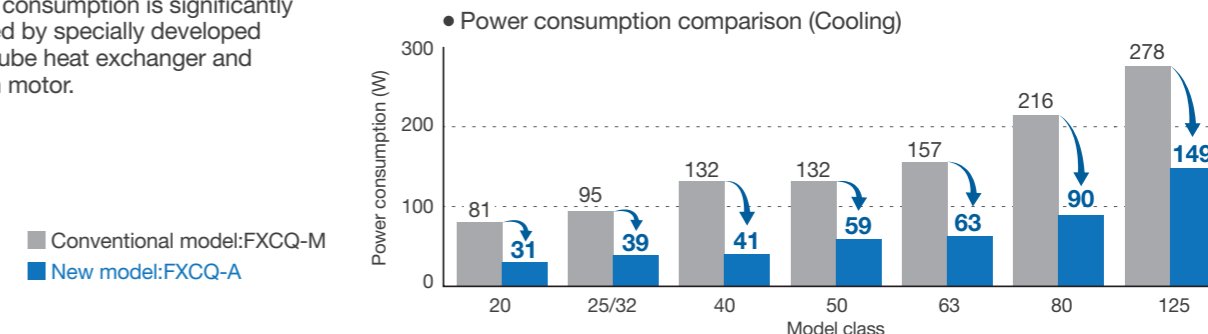

Enhanced functions from various aspects such as maintenance

- The flap parts are easy to clean because it is hard to condensate and get dirty.
- Drain pump is equipped as standard accessory with 850 mm lift.

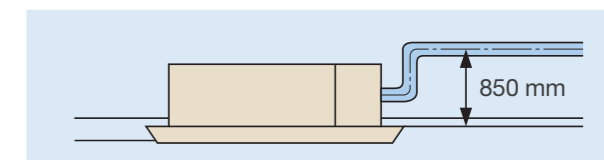

- Check contamination in drain pan by simply remove suction grille and panel.
- Equipped with long life filter which requires only 1-year maintenance interval.

- Adjuster pockets mount at four corners of the unit enable to adjust the main unit without removing the panel.



- Easy visual inspection of drainage through the transparent body drain socket.

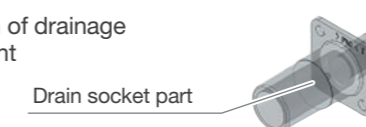

- An antibacterial treatment that uses silver ions has been applied to the drain pan, preventing the growth of slime, mould and bacteria that cause blockages and odours. (The lifespan of a silver ion cartridge depends on the usage environment, but should be changed once every two to three years.)



Specifications

MODEL		FXCQ20AVM	FXCQ25AVM	FXCQ32AVM	FXCQ40AVM	FXCQ50AVM	FXCQ63AVM	FXCQ80AVM	FXCQ125AVM
Power supply		1-phase, 220-240 V/220-230 V, 50/60 Hz							
Cooling capacity	Btu/h	7,500	9,600	12,300	15,400	19,100	24,200	30,700	47,800
	kW	2.2	2.8	3.6	4.5	5.6	7.1	9.0	14.0
Heating capacity	Btu/h	8,500	10,900	13,600	17,100	21,500	27,300	34,100	54,600
	kW	2.5	3.2	4.0	5.0	6.3	8.0	10.0	16.0
Power consumption	Cooling	0.031	0.039	0.041	0.059	0.063	0.090	0.149	
	Heating	0.028	0.035	0.037	0.056	0.060	0.086	0.146	
Casing		Galvanised steel plate							
Airflow rate (H/HM/M/ML/L)	l/s	175/158/150/133/125	192/175/158/142/133	200/183/175/158/142	250/233/217/192/175	267/250/233/208/192	433/400/375/342/308	533/492/458/417/375	
	m ³ /min	10.5/9.5/9/8/7.5	11.5/10.5/9.5/8.5/8	12/11/10.5/9.5/8.5	15/14/13/11.5/10.5	16/15/14/12.5/11.5	26/24/22.5/20.5/18.5	32/29.5/27.5/25/22.5	
Sound level (H/HM/M/ML/L)	dB(A)	32/31/30/29/28	34/33/31/30/29	34/33/32/31/30	36/35/33/32/31	37/36/35/33/31	39/38/37/35/32	42/40/38/36/33	46/44/42/40/38
	mm	305x775x620			305x990x620		305x1,445x620		
Machine weight		19			22		25		33
Piping connections	Liquid (Flare)	φ 6.4					φ 9.5		
	Gas (Flare)	φ 12.7					φ 15.9		
	Drain	VP25 (External Dia. 32/Internal Dia. 25)							
Panel (Option)	Model	BYBCQ40CF			BYBCQ63CF		BYBCQ125CF		
	Colour	Fresh white (6.5Y 9.5/0.5)							
	Dimensions (HxWxD)	55x1,070x700			55x1,285x700		55x1,740x700		
	Weight	10			11		13		

Note: Specifications are based on the following conditions:
 •Cooling: Indoor temp.: 27°CDB, 19°CWB, Outdoor temp.: 35°CDB, Equivalent piping length: 7.5 m, Level difference: 0 m.
 •Heating: Indoor temp.: 20°CDB, Outdoor temp.: 7°CDB, 6°CWB, Equivalent piping length: 7.5 m, Level difference: 0 m.
 •Capacity of indoor unit is only for reference. Actual capacity of indoor unit is based on the total capacity index. (See Engineering Data Book for details.)
 •Sound level: Anechoic chamber conversion value, measured at a point 1.5 m downward from the unit centre.
 During actual operation, these values are normally somewhat higher as a result of ambient conditions.

Ceiling Mounted Cassette (Single Flow) Type

FXEQ-A

Slim design for flexible installation

- The body features a compact design with a height of just 200 mm and depth 470 mm, making the installation possible in tight ceiling spaces.

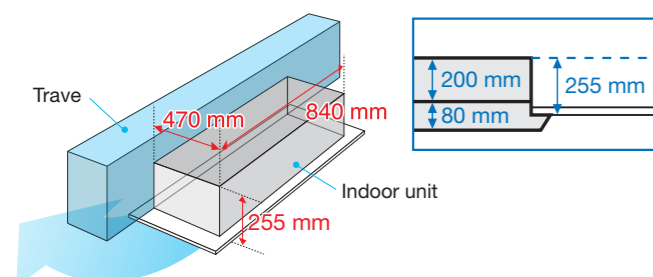

- The swinging of horizontal and vertical swing flaps can be adjusted freely with the remote controller, providing 3D airflow to every corner of the room.

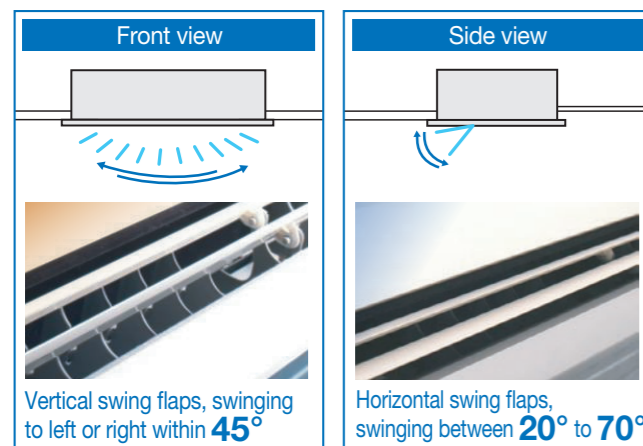

- Control of airflow rate can be selected from 5-step control and quiet operation mode, which provides comfortable airflow.

- DC motor is adopted both in the fan and drain pump of the indoor unit, not only enhancing the energy saving performance, but also reducing the operating sound and the vibration incurred to the unit.

- While creating a cozy indoor environment, the unit can prevent the suspended ceiling from being soiled by adjusting its louvre angle.



- The novel smooth panel design makes dust difficult to accumulate, thus causing the cleaning more conveniently.



- Drain pump is equipped as standard accessory with 850 mm lift.

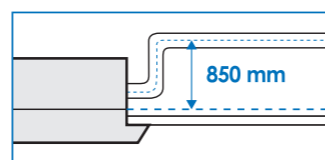

- Servicing of common parts such as the control box etc. can be performed easily only with the suction panel removed.

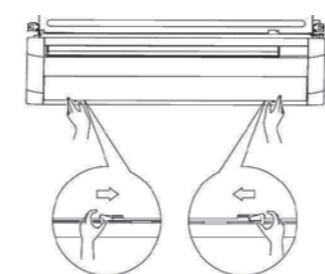

New Remote Controller (Option)

Wireless Remote Controller

- Stylish new design giving more satisfaction of ownership
- Comes in white colour
- User-friendly buttons with new functions such as 2 flaps control, 5-step airflow control, automatic airflow
- Back light function helps operating in dark rooms



BRC4M61

LCD Backlight

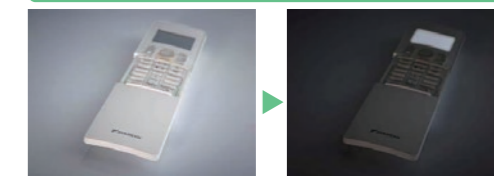

The LCD panel lights up during use, making the remote controller easy to handle even in dark.

Navigation Remote Controller (Wired Remote Controller)

New functions such as 2 flaps control, 5-step airflow control, automatic airflow can be also adjusted with the new wired remote controller.



BRC1F61



Specifications

MODEL		FXEQ20AV36	FXEQ25AV36	FXEQ32AV36	FXEQ40AV36	FXEQ50AV36	FXEQ63AV36	
Power supply		1-phase, 220-240 V, 50 Hz						
Cooling capacity	Btu/h	7,500	9,600	12,300	15,400	19,100	24,200	
	kW	2.2	2.8	3.6	4.5	5.6	7.1	
Heating capacity	Btu/h	8,500	10,900	13,600	17,100	21,500	27,300	
	kW	2.5	3.2	4.0	5.0	6.3	8.0	
Power consumption	Cooling	0.026	0.027	0.034	0.046	0.048	0.067	
	Heating	0.022	0.023	0.030	0.042	0.044	0.063	
Casing		Galvanised steel plate						
Airflow rate (H/HM/M/ML/L)	Cooling	ℓ/s	100/90/82/73/67	115/107/97/88/80	133/125/117/105/92	163/147/130/117/103	208/190/173/158/145	250/227/203/183/163
		m ³ /min	6.0/5.4/4.9/4.4/4.0	6.9/6.4/5.8/5.3/4.8	8.0/7.5/7.0/6.3/5.5	9.8/8.8/7.8/7.0/6.2	12.5/11.4/10.4/9.5/8.7	15.0/13.6/12.2/11.0/9.8
	Heating	ℓ/s	100/93/85/78/70	120/112/102/93/83	143/133/123/112/100	170/155/140/127/113	233/213/193/178/163	282/255/227/205/183
		m ³ /min	6.0/5.6/5.1/4.7/4.2	7.2/6.7/6.1/5.6/5.0	8.6/8.0/7.4/6.7/6.0	10.2/9.3/8.4/7.6/6.8	14.0/12.8/11.6/10.7/9.8	16.9/15.3/13.6/12.3/11.0
Sound level (H/HM/M/ML/L)	Cooling	30/29/28/27/26	32/31/30/29/28	35/34/33/32/30	38/37/35/33/31	38/37/35/33/31	43/41/39/37/35	
	Heating	33/31/29/28/26	35/33/31/30/28	38/36/34/33/31	41/39/37/35/33	41/39/37/36/34	46/44/42/40/38	
Dimensions (H×W×D)		200×840×470				200×1,240×470		
Machine weight		17			18		23	
Piping connections	Liquid (Flare)	φ 6.4				φ 9.5		
	Gas (Flare)	φ 12.7				φ 15.9		
	Drain	PVC26 (External Dia. 26/Internal Dia. 20)						
Panel (Option)	Model	BYEP40AW1				BYEP63AW1		
	Colour	Fresh white						
	Dimensions(H×W×D)	80×950×550				80×1,350×550		
	Weight	8.0				10.0		

Note: Specifications are based on the following conditions:

- Cooling: Indoor temp.: 27°CDB, 19°CWB, Outdoor temp.: 35°CDB, Equivalent piping length: 7.5 m, Level difference: 0 m.
- Heating: Indoor temp.: 20°CDB, Outdoor temp.: 7°CDB, 6°CWB, Equivalent piping length: 7.5 m, Level difference: 0 m.
- Capacity of indoor unit is only for reference. Actual capacity of indoor unit is based on the total capacity index. (See Engineering Data Book for details.)
- Sound level: Anechoic chamber conversion value, measured at a point 1 m in front of the unit and 1 m downward.

Slim Ceiling Mounted Duct Type (Compact Series)

FXDQ-T

Slim and compact design for easy and flexible installation

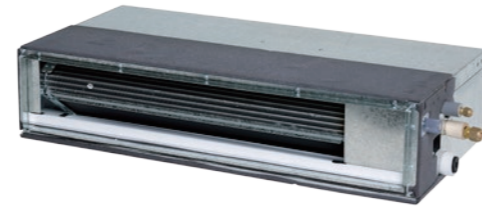

DC Fan Motor / DC Drain Pump

Adoption of a DC motor for both the fan motor and the drain pump has greatly reduced power consumption and also operation noise.

- Slim and compact design with a height of only 200 mm allows for installation in drop ceilings with ceiling voids of as little as 240 mm in height. The depth is also only 450 mm making it suitable for installation in limited spaces such as wardrobes.

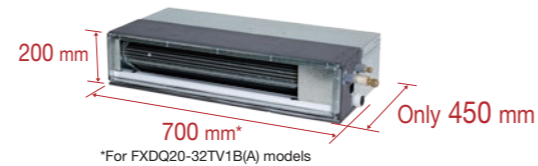

- Features rear or bottom return to suite site constraints.

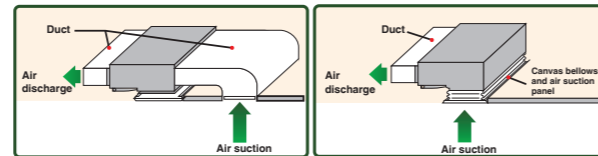

Air filter included

Clip-on resin net filter attached to the rear of the unit as standard.

- Drain pump is equipped as standard accessory with 750 mm lift.

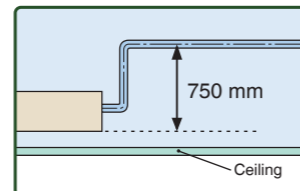

3-D Auto Swing Discharge Grille (Optional Accessory)

Motorised louvres provide 3-D airflow distribution for improved air circulation. Operations via BRC1E63 with functions including 3-D Auto Swing, Horizontal Auto Swing, Vertical Auto Swing & Fixed Positioning.

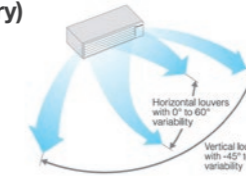

Model	Compatibility	HxWxD (mm)
BDG20A09	20-32 Class	180x722x70
BDG20A15	40-50 Class	180x922x70
BDG20A20	63 Class	180x1,122x70

Auto Clean Air Filter Module (Optional Accessory)

A unique rear suction mounted motorised filter cleaning module with included polyester filter for convenient filter maintenance. Scheduled automatic filter cleaning occurs once a week during non operational hours of the indoor unit (set via BRC1E63) to ensure optimal performance and increased energy savings.

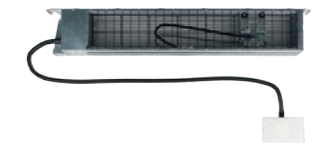

Model	Compatibility	HxWxD (mm)
BAE20A62	20-32 Class	210x840x188
BAE20A82	40-50 Class	210x1,040x188
BAE20A102	63 Class	210x1,240x188



Mounts to the rear of the indoor unit with the vacuum port installed under the ceiling



Cleaning unit moves across the filter removing dust which is collected in the dust box

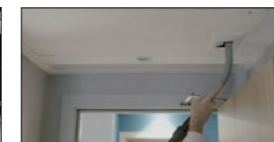

Dust in the dust box can be emptied by vacuuming out the dust via the vacuum port

Two Series Available

FXDQ-TV1B – Standard Model

FXDQ-TV1BA – Features Built-in Multi Tenancy Kit

This kit allows an independent 24V power source to be supplied to the indoor unit PCB in conjunction with 1 phase power from the tenants board. This ensures critical operations, such as oil return are not affected should there be an interruption to the main indoor unit power.

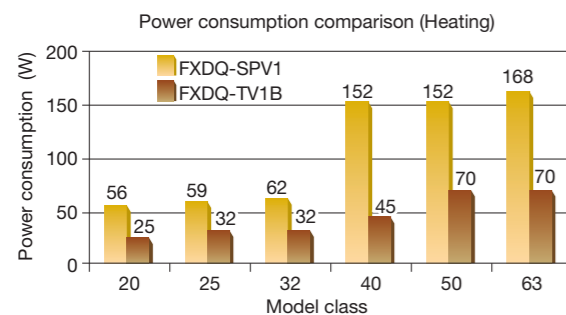
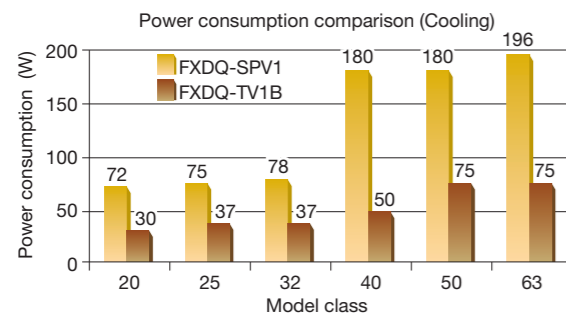

Auto & 5-step Airflow Control

Airflow rate can be selected from 5 Steps and AUTO airflow mode. AUTO will automatically regulate the airflow rate in accordance to the difference between room temperature and set temperature.



*Wireless remote controller does not have AUTO airflow mode. Use wired remote controller to select AUTO airflow mode.

Specifications

MODEL		FXDQ20TV1B(A)	FXDQ25TV1B(A)	FXDQ32TV1B(A)	FXDQ40TV1B(A)	FXDQ50TV1B(A)	FXDQ63TV1B(A)
Power supply		1-phase, 220-240 V, 50 Hz					
Cooling capacity	Btu/h	7,500	9,600	12,300	15,400	19,100	24,200
	kW	2.2	2.8	3.6	4.5	5.6	7.1
Heating capacity	Btu/h	8,500	10,900	13,600	17,100	21,500	27,300
	kW	2.5	3.2	4.0	5.0	6.3	8.0
Power consumption*1	Cooling	0.030		0.037		0.050	
	Heating	0.025		0.032		0.045	
Casing		Galvanised steel plate					
Airflow rate	ℓ/s	135	150	210	250	325	
	m ³ /min	8.1	9.0	12.6	15.0	19.5	
External static pressure	Pa	40-10*2		50-10*2		60-10*2	
Sound level (HH/H/L) *1 *3	dB (A)	32/30/28		33/30.5/28		34/31.5/29	
Dimensions (H x W x D)	mm	200x700x450			200x900x450		200x1,100x450
Machine weight	kg	18			21		24
Piping connections	Liquid (Flare)	φ 6.4					
	Gas (Flare)	φ 12.7					
	Drain	PVC26 (External Dia. 26 / Internal Dia. 20)					

Note: Specifications are based on the following conditions:

●Cooling: Indoor temp.: 27°CDB, 19°CWB, Outdoor temp.: 35°CDB, Equivalent piping length: 5 m, Level difference: 0 m.

●Heating: Indoor temp.: 20°CDB, Outdoor temp.: 7°CDB, 6°CWB, Equivalent piping length: 5 m, Level difference: 0 m.

●Capacity of indoor unit is only for reference. Actual capacity of indoor unit is based on the total capacity index. (See Engineering Data Book for details.)

●Sound level: Anechoic chamber conversion value, measured at a point 1.5 m downward from the unit centre.

During actual operation, these values are normally somewhat higher as a result of ambient conditions.

*1 : Values are based on external static pressure of 10 Pa. For FXDQ-TV1BA models, +0.0005kW on top of cooling/heating power consumption values.

*2 : External static pressure is changeable to set by the remote controller. This pressure means "High static pressure - Standard". (Factory setting is 10 Pa)

*3 : The values of operation sound level represent those for rear-suction operation. Sound level values for bottom-suction operation can be obtained by adding 5 dB(A).

Slim Ceiling Mounted Duct Type (Standard Series) FXDQ-PD / ND

Slim design, quietness and static pressure switching

Suitable to use in drop-ceilings!

- Only 700 mm in width and 23 kg in weight, this model is suitable to install in limited spaces like drop-ceilings in hotels.

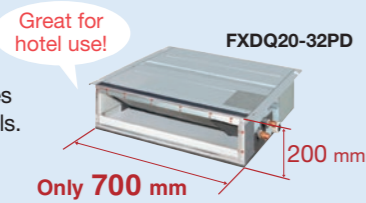

- Control of the airflow rate can be selected from 3-step control and Auto. Auto airflow rate control can be selected with wired remote controller BRC1E63.

- Low operation sound level.

- External static pressure selectable by remote controller switching make this indoor unit a very comfortable and flexible model.

10 Pa-30 Pa/factory set:
10 Pa for FXDQ-PD models.
15 Pa-44 Pa/factory set:
15 Pa for FXDQ-ND models.

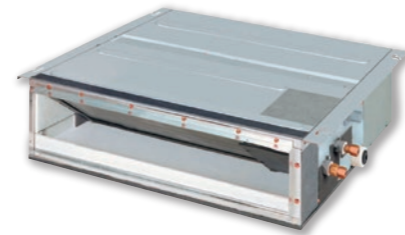
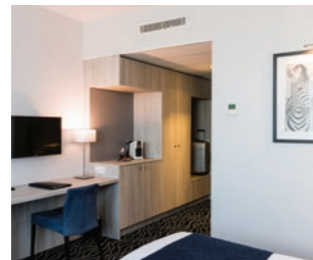

- Only 200 mm in height, this model can be installed in rooms with as little as 240 mm in height for the ceiling space between the drop-ceiling and ceiling slab.

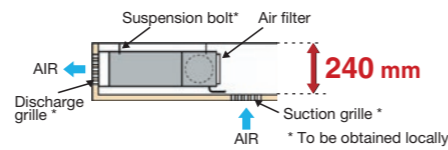

- Drain pump is equipped as standard accessory with 750 mm lift.

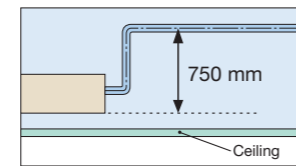

Specifications

MODEL	FXDQ20PDVE	FXDQ25PDVE	FXDQ32PDVE	FXDQ40NDVE	FXDQ50NDVE	FXDQ63NDVE
Power supply	1-phase, 220-240 V/220 V, 50/60 Hz					
Cooling capacity	Btu/h	7,500	9,600	12,300	15,400	19,100
	kW	2.2	2.8	3.6	4.5	5.6
Heating capacity	Btu/h	8,500	10,900	13,600	17,100	21,500
	kW	2.5	3.2	4.0	5.0	6.3
Power consumption*1	Cooling	0.086		0.089	0.160	0.181
	Heating	0.067		0.070	0.147	0.168
Casing	Galvanised steel plate					
Airflow rate (HH/H/L)	ℓ/s	133/120/106		175/158/141	208/183/166	275/241/216
	m³/min	8.0/7.2/6.4		10.5/9.5/8.5	12.5/11.0/10.0	16.5/14.5/13.0
External static pressure	Pa	30-10*2		44-15*2		
Sound level (HH/H/L)*1*3	dB(A)	28/26/23		28/26/24	30/28/26	33/31/29
Sound power (HH/H/L)	dB(A)	56/54/51		56/54/52	58/56/54	61/59/57
Dimensions (HxWxD)	mm	200x700x620		200x900x620		200x1,100x620
Machine weight	kg	23		27	28	31
Piping connections	Liquid (Flare)	φ6.4				φ9.5
	Gas (Flare)	φ12.7				φ15.9
	Drain	VP20 (External Dia. 26/Internal Dia. 20)				

Note: Specifications are based on the following conditions:

- Cooling: Indoor temp.: 27°CDB, 19°CWB, Outdoor temp.: 35°CDB, Equivalent piping length: 7.5 m, Level difference: 0 m.
- Heating: Indoor temp.: 20°CDB, Outdoor temp.: 7°CDB, 6°CWB, Equivalent piping length: 7.5 m, Level difference: 0 m.
- Capacity of indoor unit is only for reference. Actual capacity of indoor unit is based on the total capacity index. (See Engineering Data Book for details.)
- Sound level: Anechoic chamber conversion value, measured at a point 1.5 m downward from the unit centre.

During actual operation, these values are normally somewhat higher as a result of ambient conditions.

*1 : Values are based on the following conditions: FXDQ-PD: external static pressure of 10 Pa; FXDQ-ND: external static pressure of 15 Pa.

*2 : External static pressure is changeable to set by the remote controller. This pressure means "High static pressure - Standard" (Factory setting is 10 Pa for FXDQ-PD models and 15 Pa for FXDQ-ND models.)

*3 : The values of operation sound level represent those for rear-suction operation. Sound level values for bottom-suction operation can be obtained by adding 5 dB(A).

Ceiling Concealed (Duct) Type

FXDYQ-MA

High static pressure offers flexible duct design that blends in with any interior décor in stores and offices

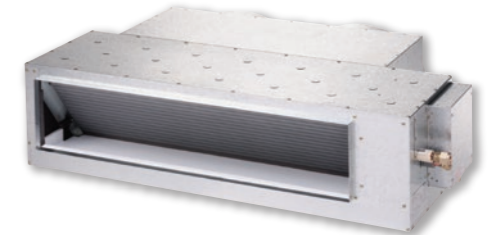

- High efficiency Hi-X heat exchanger coils that provide even more energy savings.

- High external static pressure allows comprehensive duct layout for various applications.

120 Pa for FXDYQ80MA-145MA

- Design of indoor units allows installation in limited roof spaces.

- Return air spigots included for ease of installation for FXDYQ80MA-145MA models.

- Two external static pressure settings for added flexibility.

- Quiet yet powerful supply air fan.

- High strength galvanised steel casing.

Specifications

MODEL	FXDYQ80MAV1	FXDYQ100MAV1	FXDYQ125MAV1	FXDYQ145MAV1
Power supply	1-phase, 220-240 V, 50 Hz			
Cooling capacity	Btu/h	30,000	38,200	47,400
	kW	8.8	11.2	13.9
Heating capacity	Btu/h	33,800	42,700	54,600
	kW	9.9	12.5	16.0
Power consumption	Cooling	0.415	0.700	0.780
	Heating	0.415	0.700	0.780
Casing	Galvanised steel plate			
Airflow rate (H)	ℓ/s	510	778	852
	m³/min	30.6	46.7	51.1
External static pressure	Pa	120*1		
Sound level (H)	240 V	45	46	48
Dimensions (HxWxD)	mm	360x1168x869		
Machine weight	kg	50	60	65
Piping connections	Liquid (Flare)	φ9.5		
	Gas (Flare)	φ15.9		
	Drain	VP25 (External Dia. 32/Internal Dia. 25)		

Note: Specifications are based on the following conditions:

- Cooling: Indoor temp.: 27°CDB, 19°CWB, Outdoor temp.: 35°CDB, Equivalent piping length: 7.5 m, Level difference: 0 m.
- Heating: Indoor temp.: 20°CDB, Outdoor temp.: 7°CDB, 6°CWB, Equivalent piping length: 7.5 m, Level difference: 0 m.
- Capacity of indoor unit is only for reference. Actual capacity of indoor unit is based on the total capacity index. (See Engineering Data Book for details.)
- Sound level: Anechoic chamber conversion value, measured at a point 1.5 m downward from the unit centre.

During actual operation, these values are normally somewhat higher as a result of ambient conditions.

*1 : External static pressure is changeable to change over the connectors inside electrical box (High static pressure-Standard static pressure). The data above is for high static pressure setting.

Middle Static Pressure Ceiling Mounted Duct Type

FXSQ-PA

Middle static pressure and slim design allow flexible installations



Installation flexibility

Slim design

- With a height of only 245 mm, installation is possible even in buildings with narrow ceiling spaces.

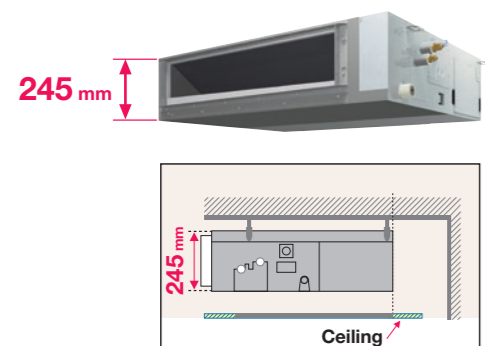

Design flexibility

Adjustable external static pressure

- Using a DC fan motor, the external static pressure can be controlled within a range of 30 Pa* to 150 Pa.

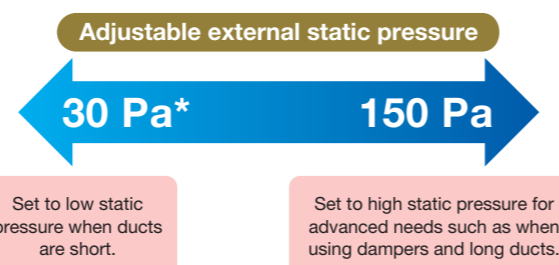

Comfortable airflow is achieved in accordance with conditions such as duct length.

*30 Pa-150 Pa for FXSQ20-40PAVE
50 Pa-150 Pa for FXSQ50-125PAVE
50 Pa-140 Pa for FXSQ140PAVE

Comfort

Switchable airflow rate

- Control of the airflow rate can be selected from 3-step control.

Auto airflow rate

- 5-step airflow rate is automatically controlled in accordance with the difference between room temperature and set temperature. Auto airflow rate control can be selected with wired remote controller BRC1E63.

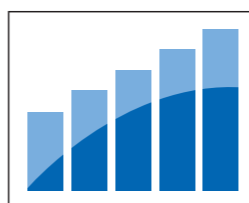

Low operation sound level

FXSQ-PAVE	20/25	32	40	50	63
Sound level (H/M/L)	33/30/28	34/32/30	36/33/30	34/32/29	36/32/29
FXSQ-PAVE	80	100	125	140	
Sound level (H/M/L)	37.5/34/30	39/35/32	42/38.5/35	43/40/36	

Standard DC drain pump

- DC drain pump is equipped as standard accessory with 850 mm lift.

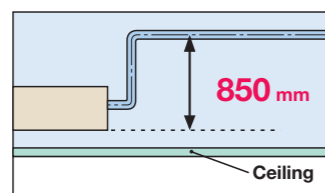

Bottom suction possible

- Bottom suction is possible which facilitate installation and maintenance. Wiring connections and maintenance of control box can be done from under the unit with an optional shield plate for side plate*, extending the degree of freedom for installation in the ceiling.

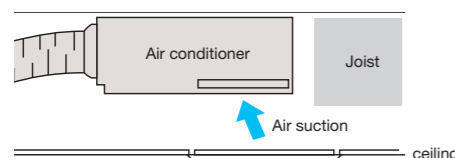

- Air suction direction can be altered from rear to bottom suction.

Rear suction

Bottom suction

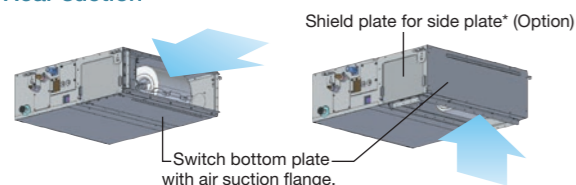

*An optional shield plate for side plate is required if wiring connections and maintenance of control box are needed from under the unit. This option is only available for FXSQ20-125PA models.



Easy installation

Airflow rate auto adjustment function

- During installation, even if the external static pressure changes due to a change in the duct route, the airflow can be automatically adjusted to within the unit's external static pressure range.

Easy maintenance

- Inspection and cleaning is facilitated by separating the drain pipe and inspection opening and by the drain pan maintenance check hole.

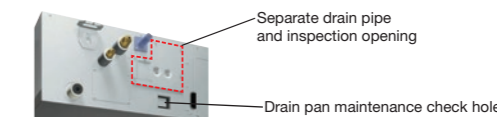

- An antibacterial treatment that uses silver ions has been applied to the drain pan, preventing the growth of slime, mould and bacteria that cause blockages and odours. (The lifespan of a silver ion cartridge depends on the usage environment, but should be changed once every two to three years.)



- Airflow rate can be controlled using a remote controller during test operation. It is automatically adjusted to the range between approximately ±10% of the rated H tap airflow.

Specifications

MODEL		FXSQ20PAVE	FXSQ25PAVE	FXSQ32PAVE	FXSQ40PAVE	FXSQ50PAVE
Power supply		1-phase, 220-240 V/220 V, 50/60 Hz				
Cooling capacity	Btu/h	7,500	9,600	12,300	15,400	19,100
	kW	2.2	2.8	3.6	4.5	5.6
Heating capacity	Btu/h	8,500	10,900	13,600	17,100	21,500
	kW	2.5	3.2	4.0	5.0	6.3
Power consumption	Cooling kW	0.058 *1		0.066 *1	0.101 *1	0.075 *1
	Heating kW	0.053 *1		0.061 *1	0.096 *1	0.070 *1
Casing		Galvanised steel plate				
Airflow rate (H/M/L)	l/s	150/125/108		158/133/116	250/208/175	283/242/192
	m ³ /min	9/7.5/6.5		9.5/8/7	15/12.5/10.5	17/14.5/11.5
External static pressure	Pa	30-150 (50) *2				50-150 (50) *2
Sound level (H/M/L)	dB(A)	33/30/28		34/32/30	36/33/30	34/32/29
Sound power (H)	dB(A)	61		62	64	62
Dimensions (H×W×D)	mm	245×550×800			245×700×800	245×1,000×800
Machine weight	kg	25			27	35
Piping connections	Liquid (Flare)	φ 6.4				
	Gas (Flare)	φ 12.7				
	Drain	VP25 (External Dia. 32/Internal Dia. 25)				
MODEL		FXSQ63PAVE	FXSQ80PAVE	FXSQ100PAVE	FXSQ125PAVE	FXSQ140PAVE
Power supply		1-phase, 220-240 V/220 V, 50/60 Hz				
Cooling capacity	Btu/h	24,200	30,700	38,200	47,800	54,600
	kW	7.1	9.0	11.2	14.0	16.0
Heating capacity	Btu/h	27,300	34,100	42,700	54,600	61,400
	kW	8.0	10.0	12.5	16.0	18.0
Power consumption	Cooling kW	0.106 *1	0.126 *1	0.151 *1	0.206 *1	0.222 *1
	Heating kW	0.101 *1	0.121 *1	0.146 *1	0.201 *1	0.217 *1
Casing		Galvanised steel plate				
Airflow rate (H/M/L)	l/s	350/292/242	383/325/267	533/450/375	617/525/433	650/558/467
	m ³ /min	21/17.5/14.5	23/19.5/16	32/27/22.5	37/31.5/26	39/33.5/28
External static pressure	Pa	50-150 (50) *2				
Sound level (H/M/L)	dB(A)	36/32/29	37.5/34/30	39/35/32	42/38.5/35	43/40/36
Sound power (H)	dB(A)	64	65.5	67	70	71
Dimensions (H×W×D)	mm	245×1,000×800		245×1,400×800		245×1,550×800
Machine weight	kg	35	37	46	47	52
Piping connections	Liquid (Flare)	φ 9.5				
	Gas (Flare)	φ 15.9				
	Drain	VP25 (External Dia. 32/Internal Dia. 25)				

Note: Specifications are based on the following conditions:

- Cooling: Indoor temp.: 27°CDB, 19°CWB, Outdoor temp.: 35°CDB, Equivalent piping length: 7.5 m, Level difference: 0 m.
- Heating: Indoor temp.: 20°CDB, Outdoor temp.: 7°CDB, 6°CWB, Equivalent piping length: 7.5 m, Level difference: 0 m.
- Capacity of indoor unit is only for reference. Actual capacity of indoor unit is based on the total capacity index. (See Engineering Data Book for details.)
- Sound level: Anechoic chamber conversion value, measured at a point 1.5 m downward from the unit centre. During actual operation, these values are normally somewhat higher as a result of ambient conditions.

- *1: Power consumption values are based on conditions of rated external static pressure.
- *2: External static pressure can be modified using a remote controller that offers thirteen (FXSQ20-40PA), eleven (FXSQ50-125PA) or ten (FXSQ140PA) levels of control. These values indicate the lowest and highest possible static pressures. The rated static pressure is 50 Pa.

Ceiling Mounted Duct Type

FXMQ-P(A)

Middle and high static pressure allows for flexible duct design

FXMQ20PA / FXMQ25PA / FXMQ32PA / FXMQ40PA
FXMQ50PA / FXMQ63PA / FXMQ80PA / FXMQ100PA
FXMQ125PA / FXMQ140PA

FXMQ160P / FXMQ180P / FXMQ200P
FXMQ250P



- Each model is fitted with a high efficiency DC fan motor with adjustable external static pressure to suit your duct design. The available ranges for each model are listed below:
30 Pa – 100 Pa for FXMQ20PA-32PA
30 Pa – 160 Pa for FXMQ40PA
50 Pa – 200 Pa for FXMQ50PA-125PA
50 Pa – 140 Pa for FXMQ140PA
60 Pa – 217 Pa for FXMQ160P
50 Pa – 210 Pa for FXMQ180P
50 Pa – 250 Pa for FXMQ200P-250P

- The adopted DC fan motor is much more energy efficient than a conventional AC motor, yielding an approximate 20% decreased in energy consumption (FXMQ125PA).

- FXMQ20PA-140PA models are only 300mm in height making it ideal for use in modern commercial and medium density apartment development where ceiling spaces are tight.

- Control of the airflow rate can be selected from 3-step control and Auto. Auto airflow rate control can be selected with wired remote controller BRC1E63 for FXMQ20PA-140PA models.

- A built-in drain pump with 700mm lift is equipped as a standard accessory for FXMQ20PA-140PA models. For FXMQ160P-250P models, a 750mm drain pump kit is available as an optional accessory.

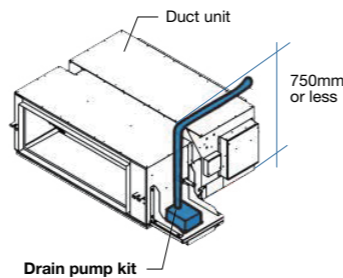

- Automatic Airflow Adjustment feature allows the fan speed to adjust automatically to suit your duct design during commissioning, simplifying the process and saving time. The airflow is adjusted to a range between ±10% of the model's rated airflow.

- To facilitate installation, the FXMQ160P-250P models can be separated into 2 sections for convenient handling and easier installation through openings in the ceiling.

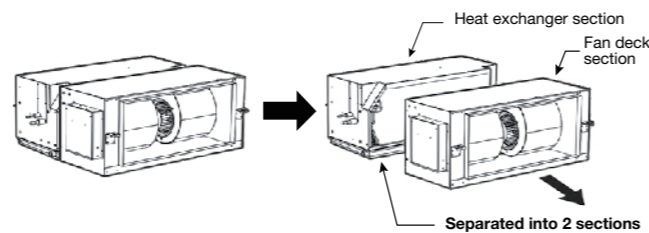

Specifications

MODEL		FXMQ20PAVE	FXMQ25PAVE	FXMQ32PAVE	FXMQ40PAVE	FXMQ50PAVE
Power supply		1-phase, 220-240 V/220 V, 50/60 Hz				
Cooling capacity	Btu/h	7,500	9,600	12,300	15,400	19,100
	kW	2.2	2.8	3.6	4.5	5.6
Heating capacity	Btu/h	8,500	10,900	13,600	17,100	21,500
	kW	2.5	3.2	4.0	5.0	6.3
Power consumption *1	Cooling	0.056		0.060	0.151	0.128
	Heating	0.044		0.048	0.139	0.116
Casing		Galvanised steel plate				
Airflow rate (HH/H/L)	ℓ/s	150/125/108		158/133/116	267/216/183	300/275/250
	m ³ /min	9/7.5/6.5		9.5/8/7	16/13/11	18/16.5/15
External static pressure*2	Pa	30-100 (50)			30-160 (100)	50-200 (100)
Sound level (HH/H/L)	dB(A)	33/31/29		34/32/30	39/37/35	41/39/37
Sound power (H)	dB(A)	51		52	57	59
Dimensions (HxWxD)	mm	300x550x700			300x700x700	300x1,000x700
Machine weight	kg	25			27	35
Piping connections	Liquid (Flare)	φ6.4				
	Gas (Flare)	φ12.7				
	Drain	VP25 (External Dia. 32/Internal Dia. 25)				

MODEL		FXMQ63PAVE	FXMQ80PAVE	FXMQ100PAVE	FXMQ125PAVE	FXMQ140PAVE
Power supply		1-phase, 220-240 V/220 V, 50/60 Hz				
Cooling capacity	Btu/h	24,200	30,700	38,200	47,800	54,600
	kW	7.1	9.0	11.2	14.0	16.0
Heating capacity	Btu/h	27,300	34,100	42,700	54,600	61,400
	kW	8.0	10.0	12.5	16.0	18.0
Power consumption *1	Cooling	0.138	0.185	0.215	0.284	0.405
	Heating	0.127	0.173	0.203	0.272	0.380
Casing		Galvanised steel plate				
Airflow rate (HH/H/L)	ℓ/s	325/292/267	417/375/333	533/450/383	650/550/466	767/649/533
	m ³ /min	19.5/17.5/16	25/22.5/20	32/27/23	39/33/28	46/39/32
External static pressure*2	Pa	50-200 (100)				50-140 (100)
Sound level (HH/H/L)	dB(A)	42/40/38	43/41/39		44/42/40	46/45/43
Sound power (H)	dB(A)	60	61		62	64
Dimensions (HxWxD)	mm	300x1,000x700		300x1,400x700		
Machine weight	kg	35		45		46
Piping connections	Liquid (Flare)	φ9.5				
	Gas (Flare)	φ15.9				
	Drain	VP25 (External Dia. 32/Internal Dia. 25)				

MODEL		FXMQ160PV1A	FXMQ180PV1A	FXMQ200PV1A	FXMQ250PV1A	
Power supply		1-phase, 220-240 V, 50 Hz				
Cooling capacity	Btu/h	61,400	68,200	76,400	95,500	
	kW	18.0	20.0	22.4	28.0	
Heating capacity	Btu/h	68,200	76,400	85,300	107,500	
	kW	20.0	22.4	25.0	31.5	
Power consumption *1	Cooling	0.650		0.640	0.810	
	Heating	0.650		0.640	0.810	
Casing		Galvanized steel plate				
Airflow rate (HH/H/L)	ℓ/s	1,120/955/790	1,160/995/820	1,200/1,025/850	1,400/1,200/1,000	
	m ³ /min	67.2/57.3/47.4	69.6/59.7/49.2	72.0/61.5/51.0	84.0/72.0/60.0	
External static pressure*2	Pa	60-217 (138)	50-210 (130)	50-250 (150)		
Sound level (HH/H/L)	dB(A)	45/41.5/38			44/40.5/37	46/42.5/39
Sound power (H)	dB(A)	73			72	74
Dimensions (HxWxD)	mm	470x1,133x919		470x1,333x919		
Machine weight	kg	70		79	85	
Piping connections	Liquid	φ9.5 (Flare)		φ9.5 (Brazing)		
	Gas	φ15.9 (Flare)		φ19.1 (Brazing)		
	Drain	BSP 3/4 internal thread (OD φ32.7)				

Note: Specifications are based on the following conditions:

•Cooling: Indoor temp.: 27°CDB, 19°CWB, Outdoor temp.: 35°CDB, Equivalent piping length: 7.5 m, Level difference: 0 m.

•Heating: Indoor temp.: 20°CDB, Outdoor temp.: 7°CDB, 6°CWB, Equivalent piping length: 7.5 m, Level difference: 0 m.

•Capacity of indoor unit is only for reference. Actual capacity of indoor unit is based on the total capacity index. (See Engineering Data Book for details.)

•Sound level: Anechoic chamber conversion value, measured at a point 1.5 m downward from the unit centre.

During actual operation, these values are normally somewhat higher as a result of ambient conditions.

*1: Power consumption values are based on conditions of rated external static pressure.

*2: External static pressure can be modified using a remote controller that offers seven (FXMQ20-32PA), thirteen (FXMQ40PA), fourteen (FXMQ50-125PA), ten (FXMQ140PA) or fifteen (FXMQ160-250P) levels of control.

These values indicate the lowest and highest possible static pressures. The rated static pressure is 50 Pa for FXMQ20-32PA 100 Pa for FXMQ40-140PA, 138 Pa for FXMQ160P, 130 Pa for FXMQ180P and 150 Pa for FXMQ200-250P.

Ceiling Suspended Type

New **FXHQ-MA / A**

Slim body with quiet and wide airflow

FXHQ32 / 63 / 100MA



New FXHQ125 / 140A

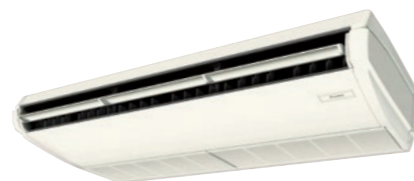

New 125 / 140 models provide greater capacity for large spaces

- The technology of the DC fan motor, wide sirocco fan, and large heat exchanger combine for greater airflow and quiet operation.

- Sophisticated design
 - Flap neatly closes when not in use.



- Suitable for high ceilings

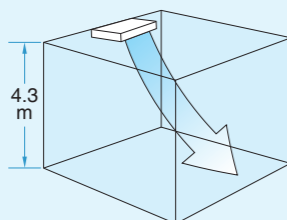

- Switchable fan speed: 3 steps

- Control of airflow rate has been improved from 2-step to 3-step.

- Drain pump kit (option) includes a silver ion antibacterial agent that assists in preventing the growth of slime, bacteria, and mould that cause smells and clogging.

- Wireless LCD remote controller

- A signal receiver must be added to the indoor unit.



BRC7M53



Signal receiver unit (Installed type)
Wireless remote controller is supplied in a set with a signal receiver.



Comfort

- Auto swing (up and down) and louvers (left and right by hand) bring comfort to the room.

- Louver manually adjusts for straight or wide angle airflow.

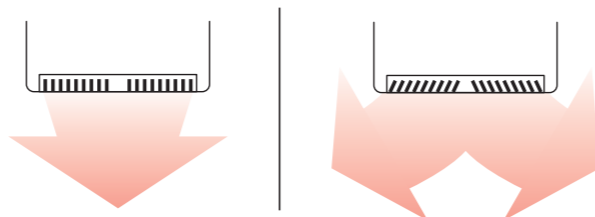

Quiet operation

- Uses quiet stream fan and other quiet technologies. (FXHQ32-100MA)

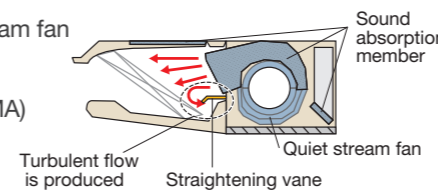

Indoor unit	Sound level		
	H	M	L
FXHQ32MA	36	—	31
FXHQ63MA	39	—	34
FXHQ100MA	45	—	37
FXHQ125A	46	41	37
FXHQ140A	48	42	37

Easy maintenance

- Non-dew flap
 - Condensation does not easily form on and dirt does not cling to non-dew flap. It is easy to clean.

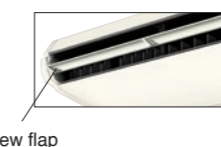

- Easy-clean, flat surfaces

- It is easy to wipe dirt off the flat side and lower surfaces of the unit.

- Oil-resistant plastic is used for the air suction grille. This satisfies durability in restaurants and other similar environments.

Note: Intended for use in salons, dining rooms, and ordinary sales floors, this specification is not suitable for kitchens or other harsh environments.

Installation flexibility

- Flexible installation
 - The unit fits more snugly into tight spaces. [Required installation space (mm)]

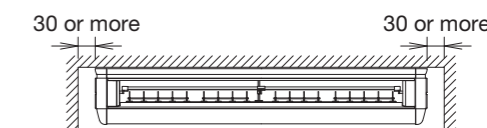

*Water used in the test-run can be drained from the air discharge opening rather than from the side as was formerly the case.

- Drain pump kit (option) can be easily incorporated.

- Drain pipe connection can be done inside the unit. Refrigerant and drain pipe outlets are at the same opening.

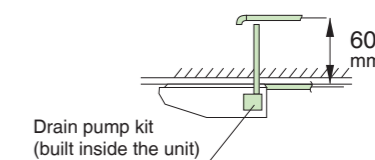

- All wiring and internal servicing can be done from under the unit.

- The rear side removable frame allows ease of access for piping work.

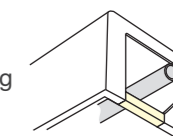

Specifications

MODEL		FXHQ32MAVE	FXHQ63MAVE	FXHQ100MAVE	FXHQ125AVM	FXHQ140AVM	
Power supply		1-phase, 220-240 V/220 V, 50/60 Hz			1-phase, 220-240 V/220-230 V, 50/60 Hz		
Cooling capacity	Btu/h	12,300	24,200	38,200	48,000	52,900	
	kW	3.6	7.1	11.2	14.1	15.5	
Heating capacity	Btu/h	13,600	27,300	42,700	54,600	58,000	
	kW	4.0	8.0	12.5	16.0	17.0	
Power consumption	Cooling	kW	0.111	0.115	0.135	0.168	0.181
	Heating	kW	0.111	0.115	0.135	0.168	0.181
Casing		Sheet Metal / White (10Y9/0.5)			Sheet Metal / White		
Airflow rate (H/M/L)	l/s	200/-/166	291/-/233	416/-/325	567/433/333	600/450/333	
	m ³ /min	12/-/10	17.5/-/14	25/-/19.5	34/26/20	36/27/20	
Sound level (H/M/L)	dB(A)	36/-/31	39/-/34	45/-/37	46/41/37	48/42/37	
	Dimensions (HxWxD)	mm	195x960x680	195x1,160x680	195x1,400x680	235x1,590x690	
Machine weight	kg	24	28	33	41		
Piping connections	Liquid (Flare)	mm	φ6.4	φ9.5			
	Gas (Flange)	mm	φ12.7	φ15.9			
	Drain		VP20 (External Dia. 26/Internal Dia. 20)				

Note: Specifications are based on the following conditions:

- Cooling: Indoor temp.: 27°CDB, 19°CWB, Outdoor temp.: 35°CDB, Equivalent piping length: 7.5 m, Level difference: 0 m.
- Heating: Indoor temp.: 20°CDB, Outdoor temp.: 7°CDB, 6°CWB, Equivalent piping length: 7.5 m, Level difference: 0 m.
- Capacity of indoor unit is only for reference. Actual capacity of indoor unit is based on the total capacity index. (See Engineering Data Book for details.)
- Sound level: Anechoic chamber conversion value, measured at a point 1 m in front of the unit and 1 m downward. During actual operation, these values are normally somewhat higher as a result of ambient conditions.

Wall Mounted Type

New **FXAQ-A**

Stylish flat panel design harmonised with your interior décor



Higher airflow

- An invisible air intake at the top of the unit
- Vertical auto-swing enables efficient air and temperature distribution throughout the room.
- The louver closes automatically when the unit stops.
- Enhanced comfort is achieved.
- 5 step discharge angles can be set by remote controller.
- Discharge angle is automatically set at the same angle as previous operation when restart.



MODEL			FXAQ20A	FXAQ25A	FXAQ32A	FXAQ40A	FXAQ50A	FXAQ63A
Airflow rate	H	m³/min	9.1	9.4	9.8	12.2	15.0	19.0
	L		7.0	7.0	7.0	9.7	12.0	14.0

Lower sound level

- Whisper quiet in operation, with sound levels as low as 28.5 dB(A)*
*Sound level for FXAQ20-32A
- An ideal solution for a wide range of commercial spaces, including individual office spaces.



Wireless LCD remote controller

- A signal receiver must be added to the indoor unit.



MODEL			FXAQ20A	FXAQ25A	FXAQ32A	FXAQ40A	FXAQ50A	FXAQ63A
Sound level	H	dB(A)	33.0	35.0	37.5	37.0	41.0	46.5
	L		28.5	28.5	28.5	33.5	35.5	38.5

- Stylish flat panel design creates a graceful harmony that enhances any interior space.
- Flat panel can be cleaned with only the single pass of a cloth across their smooth surface. Flat panel can also be easily removed and washed for more thorough cleaning.
- Drain pan and air filter can be kept clean by mould-proof polystyrene.

- Flexible installation
 - Drain pipe can be fitted to from either left or right sides.

- Drain pump kit is available as optional accessory, which lifts the drain 1,000 mm from the bottom of the unit.

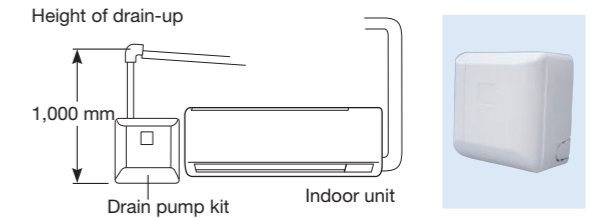

External EV kit (for heating operation) (Option)

This product, which is concealed in ceilings or corridors for quieter heating operation, is used to connect indoor units in places where quiet environment is required such as residential living rooms.

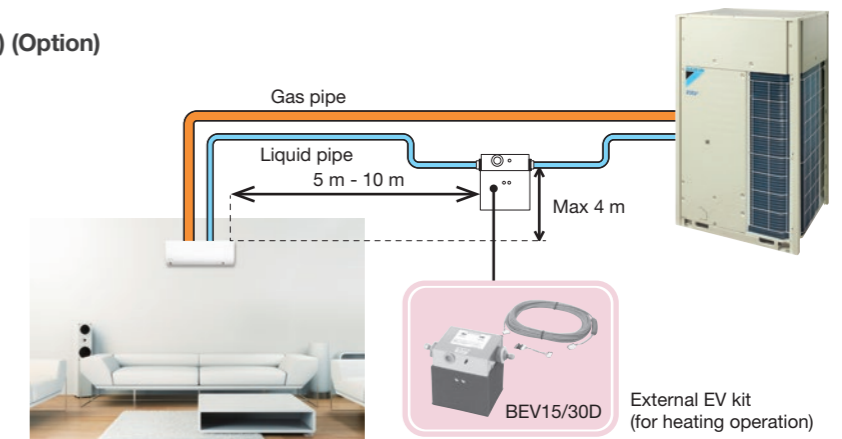

* This option is only effective for reducing operation sound during heating operation. Therefore it is ineffective when connected to cooling only outdoor units.

Specifications

MODEL		FXAQ20AVM	FXAQ25AVM	FXAQ32AVM	FXAQ40AVM	FXAQ50AVM	FXAQ63AVM
Power supply		1-phase, 220-240 V/220-230 V, 50/60 Hz					
Cooling capacity	Btu/h	7,500	9,600	12,300	15,400	19,100	24,200
	kW	2.2	2.8	3.6	4.5	5.6	7.1
Heating capacity	Btu/h	8,500	10,900	13,600	17,100	21,500	27,300
	kW	2.5	3.2	4.0	5.0	6.3	8.0
Power consumption	Cooling	0.040	0.040	0.040	0.050	0.060	0.100
	Heating	0.040	0.040	0.050	0.050	0.070	0.110
Casing		Resin / White N9.5					
Airflow rate (H/L)	ℓ/s	151/116	156/116	163/116	203/161	250/200	316/233
	m³/min	9.1/7.0	9.4/7.0	9.8/7.0	12.2/9.7	15.0/12.0	19.0/14.0
Sound level (H/L)	Cooling	33.0/28.5	35.0/28.5	37.5/28.5	37.0/33.5	41.0/35.5	46.5/38.5
	Heating	34.0/28.5	36.0/28.5	38.5/28.5	38.0/33.5	42.0/35.5	47.0/38.5
Dimensions (HxWxD)		290x795x266			290x1,050x269		
Machine weight		12			15		
Piping connections	Liquid (Flare)	φ 6.4					φ 9.5
	Gas (Flange)	φ 12.7					φ 15.9
	Drain	VP13 (External Dia. 18/Internal Dia. 15)					

Note: Specifications are based on the following conditions:
 • Cooling: Indoor temp.: 27°CDB, 19°CWB, Outdoor temp.: 35°CDB, Equivalent piping length: 7.5 m, Level difference: 0 m.
 • Heating: Indoor temp.: 20°CDB, 15°CWB, Outdoor temp.: 7°CDB, 6°CWB, Equivalent piping length: 7.5 m, Level difference: 0 m.
 • Capacity of indoor unit is only for reference. Actual capacity of indoor unit is based on the total capacity index. (See Engineering Data Book for details.)
 • Sound level: Anechoic chamber conversion value, measured at a point 1 m in front of the unit and 1 m downward.
 During actual operation, these values are normally somewhat higher as a result of ambient conditions.

Floor Standing Type

FXLQ-MA

Suitable for perimeter zone air conditioning



- Floor Standing types can be hung on the wall for easier cleaning. Running the piping from the back allows the unit to be hung on walls. Cleaning under the unit, where dust tends to accumulate, is considerably easier.
- The adoption of a fibre-less discharge grille featuring an original design to prevent condensation also helps prevent staining and makes cleaning easier.
- A long-life filter (maintenance free up to one year*) is equipped as standard accessory.

* 8 hr/day, 25 day/month. For dust concentration of 0.15 mg/m³

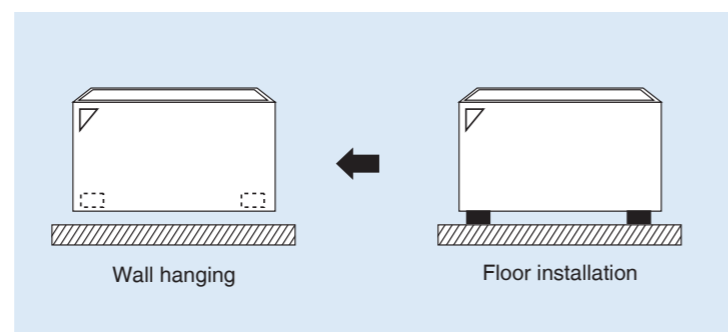

Specifications

MODEL		FXLQ20MAVE	FXLQ25MAVE	FXLQ32MAVE	FXLQ40MAVE	FXLQ50MAVE	FXLQ63MAVE
Power supply		1-phase, 220-240 V/220 V, 50/60 Hz					
Cooling capacity	Btu/h	7,500	9,600	12,300	15,400	19,100	24,200
	kW	2.2	2.8	3.6	4.5	5.6	7.1
Heating capacity	Btu/h	8,500	10,900	13,600	17,100	21,500	27,300
	kW	2.5	3.2	4.0	5.0	6.3	8.0
Power consumption	Cooling kW	0.049		0.090		0.110	
	Heating kW	0.049		0.090		0.110	
Casing		FXLQ: Ivory white (5Y7.5/1)					
Airflow rate (H/L)	ℓ/s	116/100		133/100		183/141	
	m ³ /min	7/6		8/6		11/8.5	
Sound level (H/L)	240 V	37/34		40/35		41/36	
		37/34		40/35		41/36	
Dimensions (HxWxD)	mm	600x1,000x222		600x1,140x222		600x1,420x222	
Machine weight	kg	25.0		30.0		36.0	
Piping connections	Liquid (Flare)			φ6.4		φ9.5	
	Gas (Flare)			φ12.7		φ15.9	
	Drain	210.D.					

Note: Specifications are based on the following conditions;

- Cooling: Indoor temp.: 27°CDB, 19°CWB, Outdoor temp.: 35°CDB, Equivalent piping length: 7.5 m, Level difference: 0 m.
 - Heating: Indoor temp.: 20°CDB, Outdoor temp.: 7°CDB, 6°CWB, Equivalent piping length: 7.5 m, Level difference: 0 m.
 - Capacity of indoor unit is only for reference. Actual capacity of indoor unit is based on the total capacity index. (See Engineering Data Book for details.)
 - Sound level: Anechoic chamber conversion value, measured at a point 1.5 m in front of the unit at a height of 1.5 m.
- During actual operation, these values are normally somewhat higher as a result of ambient conditions.

Concealed Floor Standing Type

FXNQ-MA

Designed to be concealed in the perimeter skirting-wall



- The unit is concealed in skirting-wall of perimeter, that enables to create high class interior design.
- The connecting port faces downward, greatly facilitating on-site piping work.

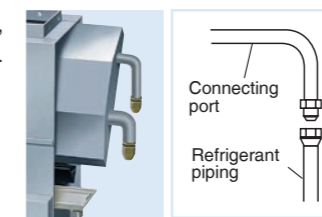

* Applies also to Floor Standing type (FXLQ-MA).

- A long-life filter (maintenance free up to one year*) is equipped as standard accessory.

* 8 hr/day, 25 day/month. For dust concentration of 0.15 mg/m³

Specifications

MODEL		FXNQ20MAVE	FXNQ25MAVE	FXNQ32MAVE	FXNQ40MAVE	FXNQ50MAVE	FXNQ63MAVE
Power supply		1-phase, 220-240 V/220 V, 50/60 Hz					
Cooling capacity	Btu/h	7,500	9,600	12,300	15,400	19,100	24,200
	kW	2.2	2.8	3.6	4.5	5.6	7.1
Heating capacity	Btu/h	8,500	10,900	13,600	17,100	21,500	27,300
	kW	2.5	3.2	4.0	5.0	6.3	8.0
Power consumption	Cooling kW	0.049		0.090		0.110	
	Heating kW	0.049		0.090		0.110	
Casing		FXNQ: Galvanised steel plate					
Airflow rate (H/L)	ℓ/s	116/100		133/100		183/141	
	m ³ /min	7/6		8/6		11/8.5	
Sound level (H/L)	240 V	37/34		40/35		41/36	
		37/34		40/35		41/36	
Dimensions (HxWxD)	mm	610x930x220		610x1,070x220		610x1,350x220	
Machine weight	kg	19.0		23.0		27.0	
Piping connections	Liquid (Flare)			φ6.4		φ9.5	
	Gas (Flare)			φ12.7		φ15.9	
	Drain	210.D.					

Note: Specifications are based on the following conditions;

- Cooling: Indoor temp.: 27°CDB, 19°CWB, Outdoor temp.: 35°CDB, Equivalent piping length: 7.5 m, Level difference: 0 m.
 - Heating: Indoor temp.: 20°CDB, Outdoor temp.: 7°CDB, 6°CWB, Equivalent piping length: 7.5 m, Level difference: 0 m.
 - Capacity of indoor unit is only for reference. Actual capacity of indoor unit is based on the total capacity index. (See Engineering Data Book for details.)
 - Sound level: Anechoic chamber conversion value, measured at a point 1.5 m in front of the unit at a height of 1.5 m.
- During actual operation, these values are normally somewhat higher as a result of ambient conditions.

Ceiling Mounted Cassette (Compact Multi Flow) Type

FFQ-B

Quiet, compact, and designed for user comfort

- Designed to fit 600 mm wide ceiling grids

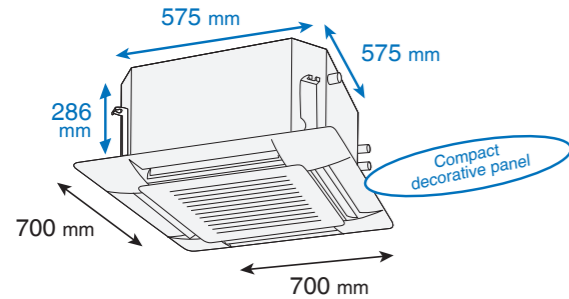

Option
Note: Remote controller cables not included. Cables should be obtained locally.



Option



Signal receiver unit
Note: Wireless remote controllers and signal receiver units are sold as a set.

- T-bar grid does not need to be cut.

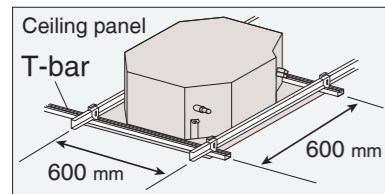

- Low draft performance is designed for your comfort.

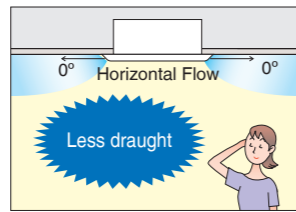

- Drain pump is equipped as standard accessory with 750 mm lift.

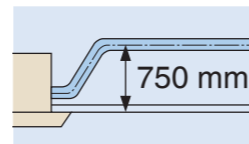

- Comfortable across all areas

Conditioned air is distributed evenly by Auto-swing operation.

Adjustable airflow angle to suit all room conditions.

	AUTO-SWING	5 direction
Standard setting	<p>Auto-swing between 0° and 60°</p>	<p>Settable to 5° different levels between 0° and 60°</p>
Draft prevention setting (Set on site)	<p>Auto-swing between 0° and 35°</p>	<p>Settable to 5° different levels between 0° and 35°</p>
Setting to prevent soiling of ceiling (Set on site)	<p>Auto-swing between 25° and 60°</p>	<p>Settable to 5° different levels between 25° and 60°</p>

Note: Angles shown above are provided as a guide. They may differ depending on the installation site.

Specifications

MODEL	FFQ25BV1B	FFQ35BV1B	FFQ50BV1B	FFQ60BV1B	
Power supply	1-phase, 220-240 V, 50 Hz				
Airflow rate (H)	m ³ /min(l/s)	9.0 (150)	10.0 (167)	12.0 (200)	15.0 (250)
Sound level (H/L)*	dB(A)	29.5/24.5	32/25	36/27	41/32
Sound power level (H)	dB(A)	46.5	49	53	58
Fan speed	2 steps				
Temperature control	Microcomputer control				
Dimensions (H×W×D)	mm 286x575x575				
Machine weight	kg 17.5				
Piping connections	Liquid (Flare)	φ6.4			
	Gas (Flare)	φ9.5			
	Drain	φ12.7			
Heat insulation	VP20 (External Dia. 26/Internal Dia. 20)				
Panel (Option)	Model	BYFQ60B3W1			
	Colour	White			
	Dimensions(H×W×D)	mm 55x700x700			
	Weight	kg 2.7			

Note: * Anechoic chamber conversion value, measured according to JIS parameters and criteria. During operation these values are somewhat higher owing to ambient conditions.

Indoor Unit Lineup

Slim Ceiling Mounted Duct Type

FDXS-C

Slim and smooth design suits your shallow ceiling

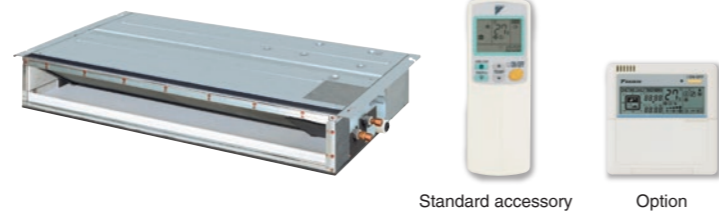

Models in the FDXS25/35 series are only 900 mm in width and 25 kg in weight, so are easily installed in limited spaces. Just 200 mm in height, all models can be installed in rooms with as little as 240 mm depth between the drop ceiling and ceiling slab, making them ideal for even shallow ceilings.

Home Leave Operation prevents large rises or falls in the indoor temperature by continuing operation* while you are sleeping or out of your home. This means that an air-conditioned welcome awaits when you wake or return. It also means that the indoor temperature can quickly return to your favourite comfort setting.

* Home Leave Operation can be selected for any temperature from 18 to 32°C for cooling operation and 10 to 30°C for heating operation.
* Home Leave Operation function must be set using the remote controller when going to sleep or leaving the house, and after waking up or returning home.

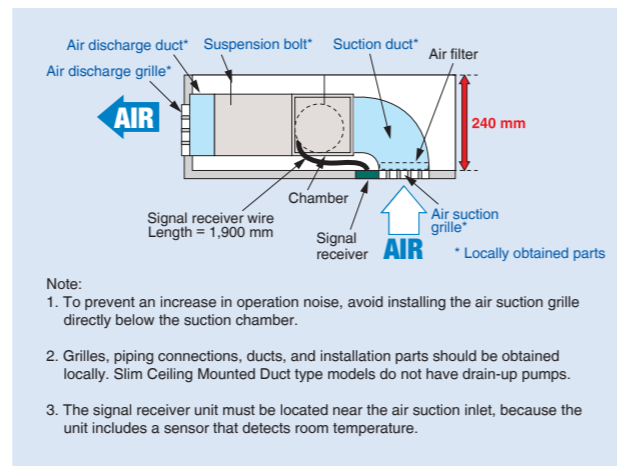
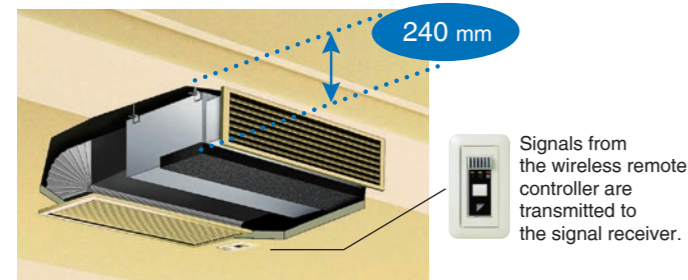
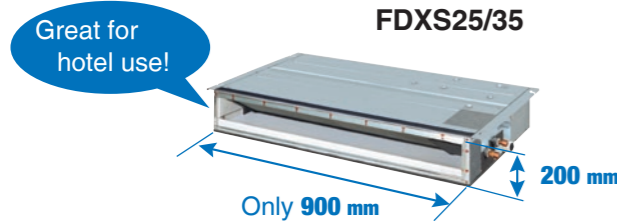

- Note:
- To prevent an increase in operation noise, avoid installing the air suction grille directly below the suction chamber.
 - Grilles, piping connections, ducts, and installation parts should be obtained locally. Slim Ceiling Mounted Duct type models do not have drain-pumps.
 - The signal receiver unit must be located near the air suction inlet, because the unit includes a sensor that detects room temperature.

Specifications

MODEL	FDXS25CVMA	FDXS35CVMA	FDXS50CVMA	FDXS60CVMA
Power supply	1-phase, 220-240 V/220-230 V, 50/60 Hz			
Airflow rate (H)	m ³ /min(ℓ/s) 9.5 (158)	10.0 (167)	12.0 (200)	16.0 (267)
Sound level (H/L/SL)*	dB(A) 35/31/29		37/33/31	38/34/32
Sound power (H)	53		55	56
Fan speed	5 steps, quiet and automatic			
Temperature control	Microcomputer control			
Dimensions (HxWxD)	mm 200x900x620		200x1,100x620	
Machine weight	kg 25	27	30	
Piping connections	Liquid (Flare)	φ6.4		
	Gas (Flare)	φ9.5		
	Drain	VP20 (External Dia. 26/Internal Dia. 20)		
Heat insulation	Both liquid and gas pipes			
External static pressure	Pa 40			

Note: * The operation sound level values represent those for rear-suction operation and an external static pressure of 40 Pa. Sound level values for bottom-suction operation can be obtained by adding 5 dB (A).

Residential Indoor Units with connection to BP units

Wall Mounted Type

FTXS-K(A)

Stylish flat panel harmonises with your interior décor



Intelligent Eye with its infrared sensor automatically controls air conditioner operation according to human movement in a room. When there is no movement, it adjusts the temperature by 2°C for energy savings.

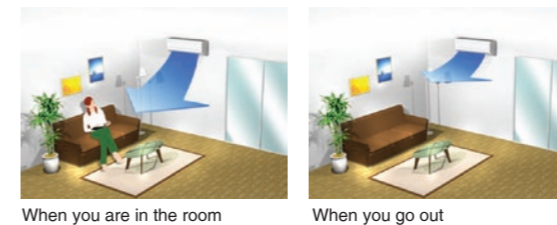

Comfort Airflow Mode prevents uncomfortable drafts from blowing directly on to your body. With this function, when you press the COMFORT button during cooling operation, the flap moves upward to prevent direct cold drafts. During heating operation, it also moves downward to prevent direct drafts and deliver warm air to the floor.

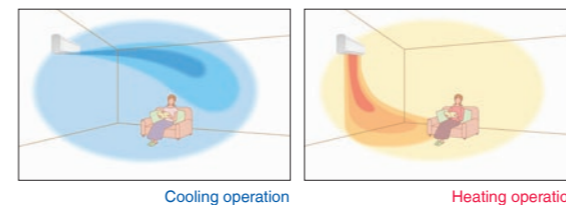

Titanium Apatite Deodorising Filter

While the filter's micron-level fibres trap dust, titanium apatite effectively adsorbs odours and allergens, as well as deodorises odours.

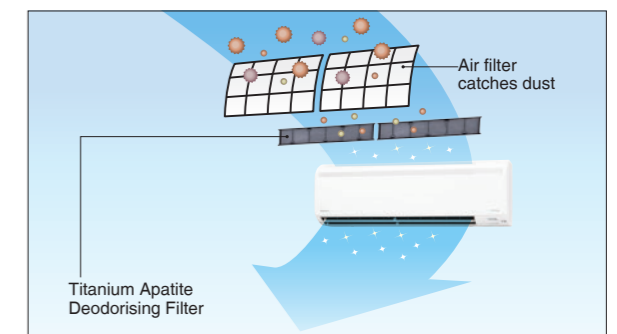

This filter is not a medical device. Benefits such as the adsorption of odours and allergens and deodorisation of odours are only effective for substances which are directly attached to the Titanium Apatite Deodorising Filter.

Specifications

MODEL	FTXS20KVMA	FTXS25KVMA	FTXS35KVMA	FTXS50KAVMA	FTXS60KAVMA	FTXS71KAVMA
Power supply	1-phase, 220-240 V/220-230 V, 50/60 Hz					
Front panel colour	White					
Airflow rate (H)	Cooling	m ³ /min(ℓ/s) 9.7 (161)	11.3 (188)	14.7 (245)	16.2 (270)	17.4 (290)
	Heating	10.5 (175)	11.5 (191)	16.2 (270)	17.4 (290)	21.5 (358)
Sound level (H/L/SL)	Cooling	dB(A) 38/25/22	42/26/23	44/35/32	45/36/33	46/37/34
	Heating	39/28/25	42/29/26	42/33/30	44/35/32	46/37/34
Sound power (H)	Cooling	54	58	60	61	62
	Heating	55	58	60	60	62
Fan speed	5 steps, quiet and automatic					
Temperature control	Microcomputer control					
Dimensions (HxWxD)	mm 295x800x215		290x1,050x250			
Machine weight	kg 9	10	12			
Piping connections	Liquid (Flare)	φ6.4				
	Gas (Flare)	φ9.5		φ12.7		φ15.9
	Drain	I.D φ14.0xO.D φ18.0				
Heat insulation	Both liquid and gas pipes					

BP Units for Connection to Residential Indoor Units

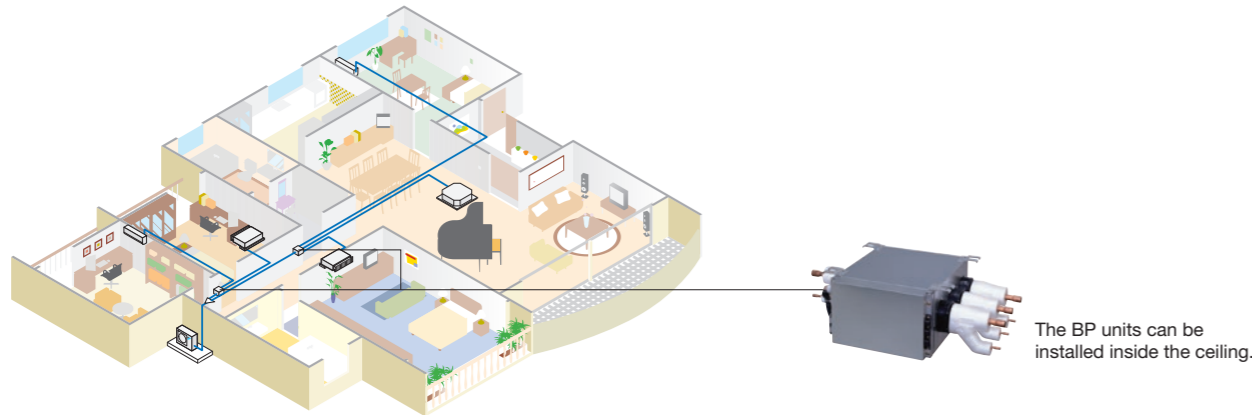

The BP units can be installed inside the ceiling.

Connectable to Residential Indoor Units

BP units allow VRV systems to be connected to Daikin's stylish and quiet residential indoor units.



Quiet Operating Sound

Expansion valves tend to create refrigerant passing noise. However, this noise can be reduced by installing the valves in BP units. The units can be fitted inside the ceiling or roof-space far from an indoor unit. Some Daikin residential indoor units also provide minimum sound levels of just 22 dB(A). Together these features ensure your system continues to operate as quietly as possible.

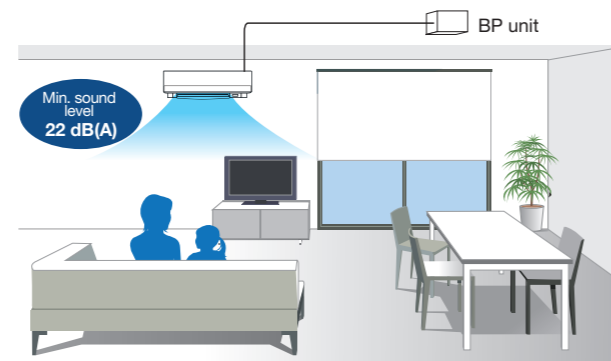

Specifications

MODEL		BPMKS967A3	BPMKS967A2
Power supply		1-phase, 220-240 V/220-230 V, 50/60 Hz	
Number of ports		3 (connectable to 1-3 indoor units)	2 (connectable to 1-2 indoor units)
Power consumption		W 10	
Running current		A 0.05	
Dimensions (HXWxD)		mm 180X294(+356*)X350	
Machine weight		kg 8	kg 7.5
Number of wiring connections		3 for power supply (including earth wiring), 2 for interunit wiring (outdoor unit-BP, BP-BP), 4 for interunit wiring (BP-indoor unit)	2 for power supply (including earth wiring), 2 for interunit wiring (outdoor unit-BP, BP-BP), 3 for interunit wiring (BP-indoor unit)
Piping connections (Brazeing)	Liquid	Main Branch	mm $\phi 9.5 \times 1$
		Branch	mm $\phi 6.4 \times 3$
	Gas	Main Branch	mm $\phi 19.1 \times 1$
		Branch	mm $\phi 15.9 \times 3$
Heat insulation		Both liquid and gas pipes	
Connectable indoor units		2.0 kW class to 7.1 kW class	
Min. rated capacity of connectable indoor units		kW 2.0	
Max. rated capacity of connectable indoor units		kW 20.8	kW 14.2

Note: * Total auxiliary piping length.



BPMKS967A3

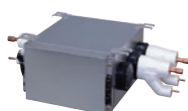

BPMKS967A2

BS Units for Heat Recovery

Specifications — Individual BS Unit

MODEL		BSQ100AV1	BSQ160AV1	BSQ250AV1	
Power supply		1-phase, 220-240 V, 50 Hz			
No. of branches		1			
Total capacity index of connectable indoor units		20 to 100	More than 100 but 160 or less	More than 160 but 250 or less	
No. of connectable indoor units		Max. 5	Max. 8	Max. 8	
Casing		Galvanised steel plate			
Dimensions (HxWxD)		mm 207x388x326			
Piping connections	Indoor Unit	Liquid	mm $\phi 9.5$ (Brazeing)* ¹	$\phi 9.5$ (Brazeing)	$\phi 9.5$ (Brazeing)
		Gas	mm $\phi 15.9$ (Brazeing)* ¹	$\phi 15.9$ (Brazeing)* ²	$\phi 22.2$ (Brazeing)* ³
	Outdoor Unit	Liquid	mm $\phi 9.5$ (Brazeing)	$\phi 9.5$ (Brazeing)	$\phi 9.5$ (Brazeing)
		Suction gas	mm $\phi 15.9$ (Brazeing)	$\phi 15.9$ (Brazeing)* ²	$\phi 22.2$ (Brazeing)* ³
	High and low pressure gas	mm $\phi 12.7$ (Brazeing)	$\phi 12.7$ (Brazeing)* ²	$\phi 19.1$ (Brazeing)* ³	
Machine weight		kg 11	kg 11	kg 14	
Sound level		dB(A) 35(40)* ⁴	dB(A) 41(45)* ⁴	dB(A) 41(45)* ⁴	

Note: ★ 1. When connecting with an indoor unit with a capacity index between 20 and 50, connect the attached pipe to the field pipe. (Braze the connection between the attached and field pipe.)

★ 2. When connecting with indoor units with total capacity indexes 150 or more and 160 or less, connect the attached pipe to the field pipe. (Braze the connection between the attached and field pipe.)

★ 3. When connecting with indoor units with a capacity index of 200, or with total capacity indexes more than 160 and less than 200, connect the attached pipe to the field pipe. (Braze the connection between the attached and field pipe.)

★ 4. Figures in brackets () indicate maximum value of transient sound (the change of cooling and heating).

• Do not install at the place such as bed room. Small sound of refrigerant will be made, which may be disturbing.

Specifications — Centralised BS Unit

MODEL		BS4Q14AV1	BS6Q14AV1	BS8Q14AV1	BS10Q14AV1	BS12Q14AV1	BS16Q14AV1	
Power supply		1-phase, 220-240 V, 50 Hz						
No. of branches		4	6	8	10	12	16	
Capacity index of connectable indoor units of branch		Max. 140						
Capacity index of connectable indoor units		Max. 400	Max. 600	Max. 750				
No. of connectable indoor units per branch		5						
Casing		Galvanised steel plate						
Dimensions (HxWxD)		mm 298x370x430	mm 298x580x430	mm 298x820x430		mm 298x1060x430		
Piping connections	Indoor Unit	Liquid	mm $\phi 6.4, \phi 9.5$ Brazeing* ¹					
		Gas	mm $\phi 12.7, \phi 15.9$ Brazeing* ¹					
	Outdoor Unit	Liquid	mm $\phi 9.5$ Brazeing* ²	mm $\phi 12.7$ Brazeing* ²	mm $\phi 12.7$ Brazeing ($\phi 15.9$)* ²	mm $\phi 15.9$ Brazeing* ²	mm $\phi 15.9$ Brazeing ($\phi 19.1$)* ²	mm $\phi 19.1$ Brazeing* ²
		Suction gas	mm $\phi 22.2$ Brazeing ($\phi 19.1$)* ²	mm $\phi 28.6$ Brazeing* ²		mm $\phi 28.6$ Brazeing ($\phi 34.9$)* ²		mm $\phi 34.9$ Brazeing* ²
	High and low pressure gas	mm $\phi 19.1$ Brazeing ($\phi 15.9$)* ²	mm $\phi 19.1$ Brazeing ($\phi 22.2$)* ²	mm $\phi 19.1$ Brazeing ($\phi 22.2, 28.6$)* ²	mm $\phi 28.6$ Brazeing* ²			
Machine weight		kg 17	kg 24	kg 26	kg 35	kg 38	kg 50	
Sound level		dB(A) 38(45)* ³	dB(A) 39(47)* ³	dB(A) 40(48)* ³		dB(A) 41(49)* ³		
Drain pipe size		mm VP20 (External Dia. 26/Internal Dia. 20)						

Note: ★ 1. When connecting with an indoor unit with a capacity index between 20 and 50, connect the attached pipe to the field pipe. (Braze connection between the attached and field pipe.)

★ 2. Reducer may be required (obtain locally) if joint diameter does not fit on the triple piping side. Figures in brackets () is the size when using the attached reducer. Insulators are necessary (obtain locally) for piping connections on the outdoor unit side.

★ 3. Figures in brackets () indicate maximum value of transient sound (the change of cooling and heating).

• Must be installed in locations where the noise generated by the BS unit does not cause any problem.

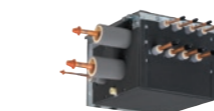

4 branch



16 branch

Air Handling Unit

■ Air Handling Unit

Integrate your air handling unit in a total solution for large size spaces such as factories and large stores.

AHUR
Capacity range : 6 – 160 class



- Easy design and installation
 - The system is easy to design and install since no additional water systems such as boilers, tanks and gas connections etc are required.
- Inverter controlled units
- Control of air temperature via standard Daikin wired remote control for standard series

System overview

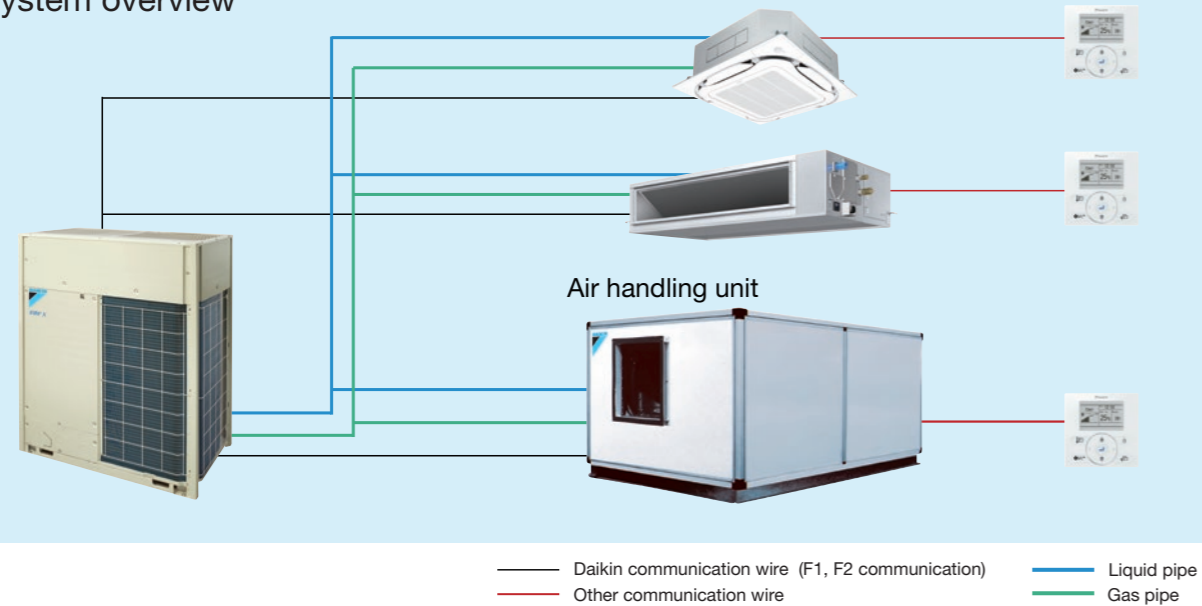

Daikin air handling units can be connected to VRF systems. This combination can be built to order as a system. Outdoor air series is also possible. Please contact your local sales office for details.



Air Treatment Equipment Lineup

Daikin's air treatment systems creating a higher air quality environment

Components of Indoor Air Quality

Ventilation, Humidification, Air Processing*

*Refers to bringing outdoor air to near indoor temperature and delivering to a room.

A recent trend rapidly gaining popularity is for air treatment to be required as well as air conditioning. Daikin's Outdoor-Air Processing Unit can combine fresh air treatment and air conditioning, supplied from a single system. It adjusts the temperature of air from outdoors using a fixed discharge temperature control. Along with Outdoor-Air Processing Units, we also offer Heat Reclaim Ventilator systems. The Heat Reclaim Ventilator VAM-GJ series units in particular have been praised for their compactness, energy conservation and extensive operation range of outdoor temperatures. This series provides higher enthalpy efficiency \star_1 due to the greatly enhanced performance of the thin film element. Furthermore, improved external static pressure \star_2 offers more flexibility for installation. The Heat Reclaim Ventilator VKM-GAM series units, equipped with a DX-coil and a humidifier, provide further advanced features, such as temperature adjustment to suit conditions indoors and to prevent cold air from blowing on people directly during heating operation. The series also realises significant energy savings by exercising heat recovery.

\star_1 For models: VAM150/250/350/650/800/1000/2000GJVE
 \star_2 For models: VAM150/350/500GJVE

	Outdoor-Air Processing Unit	Heat Reclaim Ventilator			
		VKM-GAM Type	VKM-GA Type	VAM-GJ Type	
Connections with VRV system	Refrigerant Piping	Connectable	Connectable	Not connectable	
	Wiring	Connectable	Connectable	Connectable	
	After-cool & After-heat Control	Available	Available	Not available	
Heat Exchange Element	—	Energy savings obtained		Energy savings obtained	
Humidifier	—	Fitted	—	—	
High Efficiency Filter	Option	Option		Option	
Ventilation System	Air supply only	Air supply & air exhaust		Air supply & air exhaust	
Power Supply	220-240 V, 50 Hz	220-240 V, 50 Hz		220-240 V/220 V, 50/60 Hz	
Airflow Rate				150 m ³ /h	
				250 m ³ /h	
				350 m ³ /h	
			500 m ³ /h		500 m ³ /h
				650 m ³ /h	650 m ³ /h
			800 m ³ /h		800 m ³ /h
		1080 m ³ /h	1000 m ³ /h		1000 m ³ /h
		1680 m ³ /h			1500 m ³ /h
	2100 m ³ /h			2000 m ³ /h	

*Refers to bringing outdoor air to near indoor temperature and delivering to a room.

Air Treatment Equipment Lineup

Outdoor-Air Processing Unit

Combine fresh air treatment and air conditioning, supplied from a single system.

Lineup

Model Name	FXMQ125MFV1	FXMQ200MFV1	FXMQ250MFV1
Capacity Index	125	200	250



Fresh air treatment and air conditioning can be achieved with a single system by using heat pump technology—without the usual troublesome air supply and air discharge balance design. Fan coil units for air conditioning and an outdoor-air processing unit can be connected to the same refrigerant line. The results are enhanced design flexibility and a significant reduction in total system costs.

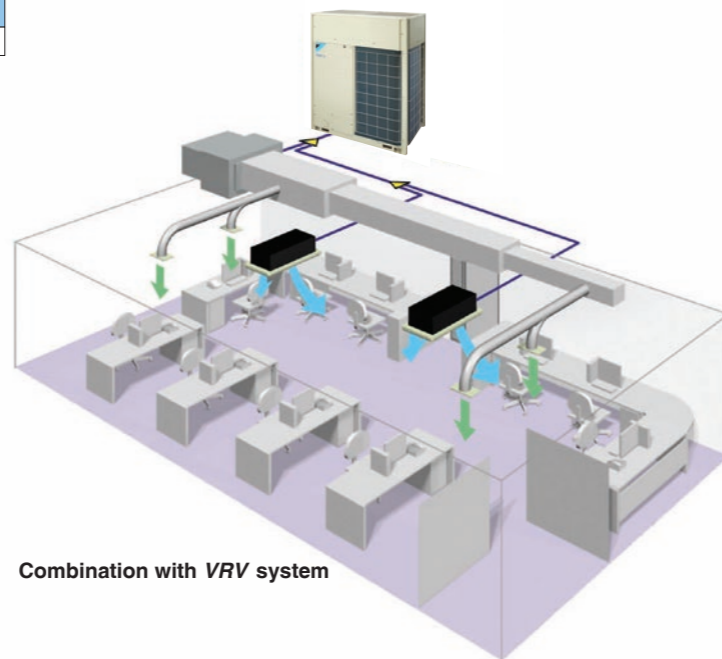

Combination with VRV system

Air conditioning and outdoor air processing can be accomplished using a single system.

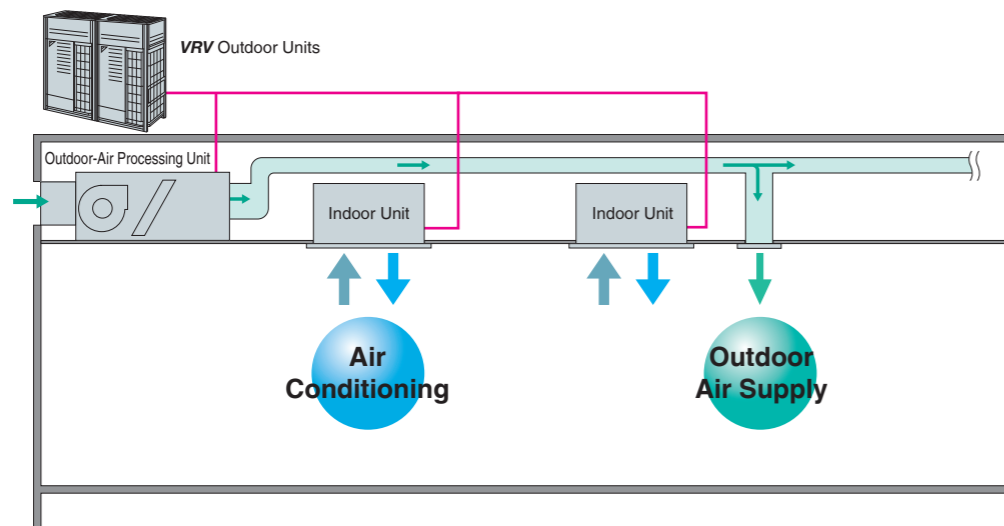

Connection Conditions

The following restrictions must be observed in order to maintain the indoor units connected to the same system.

- When outdoor-air processing units are connected, the total connection capacity index must be 50% to 100% of the capacity index of the outdoor units.
- When outdoor-air processing units and standard indoor units are connected, the total connection capacity index of the outdoor-air processing units must not exceed 30% of the capacity index of the outdoor units. Because connection is possible depending on conditions even when the capacity index of outdoor-air processing units exceeds 30% of the capacity index of the outdoor units, contact your local distributor.
- Outdoor-air processing units can be used without indoor units.

- The unit introduces outdoor air and adjusts the outdoor air temperature via fixed discharge temperature control, thereby reducing the air conditioning load.
- * The system can operate with outdoor-air temperatures ranging from -5 to 43°C. Heating performance is somewhat adversely affected when the outdoor-air temperature is 0°C or below.
- * When shipped from the factory, the thermostat is set at 18°C for cooling and 25°C for heating. The set temperature can be varied within the range of 13–25°C during cooling operation, and 18–30°C during heating operation, in the local setting mode using the wired remote controller. The temperature, however, is not displayed on the remote controller.
- * While in machine protection mode and depending on outdoor air conditions, discharge air temperature may not be at the set temperature.
- * The fan stops when operating in defrosting, oil returning and hot start operations. The fan also may stop due to mechanical protection control.
- Ceiling mounted duct units with three differing capacities are available. These can be connected to VRV series outdoor units to meet a variety of different requirements.

Airflow rate

FXMQ125MFV1	1,080 m ³ /h
FXMQ200MFV1	1,680 m ³ /h
FXMQ250MFV1	2,100 m ³ /h

- Optional equipment includes long-life filters.
- Compatible with outdoor temperatures from -5°C to 43°C.

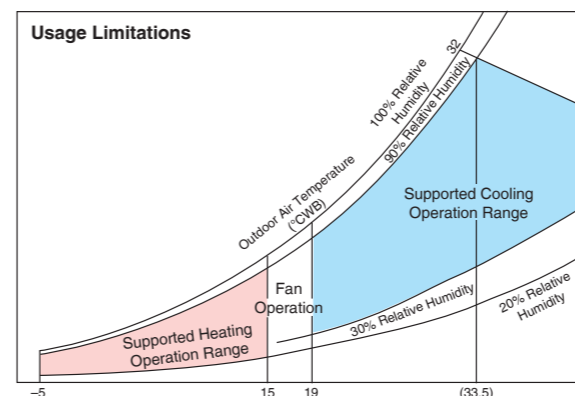

Note:

1. The data shown in the graph illustrates the supported operation ranges under the following conditions.
Indoor and Outdoor Unit
Effective piping length: 7.5 m
Height differential: 0 m
2. The discharge temperature can be set using the remote controller. However, the actual temperature may not match the temperature setting under some circumstances due to the outdoor-air processing load or mechanical protection controls.
3. The system will not operate in fan mode when the outdoor air temperature is 5°C or below.

- High-performance filters with dust collection efficiencies (JIS calorimetry) of 90% and 65% are also available as options.

- As with the VRV system, a variety of control systems can be deployed, including remote control from distances of up to 500 m.



BRC1E63
"Nav Ease"
(Wired remote controller)
(option)

- * Group control is not possible between this unit and standard type indoor units. Connect remote controllers to each unit.

- The "self-diagnosis function" indicates the occurrence and nature of abnormalities in the system by displaying codes on the remote controller.

- A central control system compatible with the VRV system can be installed.



DCS302CA61
Central remote controller
(option)

- * It is not possible to change the discharge air temperature settings from the central control system.
- * Do not associate this equipment into zones with standard indoor units, as central control will not be possible.

- As with the VRV system, the equipment employs the "super wiring system" so that the wiring linking indoor and outdoor units can also be utilised for central control.

Note:

- Linked control of the product and the Heat Reclaim Ventilator is not supported.
- This equipment is intended for the treatment of outdoor air only. It is not to be used for maintaining indoor air temperature. Install and use with standard indoor units. Be sure to position the air discharge openings of the product in positions where the airflow will not blow on people directly. When outdoor-air processing is in excess, the unit switches to thermo-off mode, and outdoor air flows into the room directly.
- For outdoor ducts, be sure to provide heat insulation to prevent condensation.
- Group control of the product and the standard indoor units is not supported. A separate remote controller should be connected to each individual unit.
- The system will not operate in fan mode when the outdoor air temperature is 5°C or below.
- If the product is allowed to operate 24 hours a day, maintenance (part replacement, etc.) must be performed periodically.
- Temperature setting and Power Proportional Distribution (PPD) are not possible even if the intelligent Touch Controller or the intelligent Touch Manager is installed.
- The remote controller wired to the outdoor-air processing unit must not be set as the master remote controller. Otherwise, when set to "Auto," the operation mode will switch according to the outdoor air conditions, regardless of the indoor temperature.

Air Treatment Equipment Lineup

Standard Specifications

Indoor unit

Type		Ceiling Mounted Duct Type		
Model		FXMQ125MFV1	FXMQ200MFV1	FXMQ250MFV1
Power supply		1-phase 220-240 V (also required for indoor units), 50 Hz		
Cooling capacity *1	Btu/h	47,800	76,400	95,500
	kW	14.0	22.4	28.0
Heating capacity *1	Btu/h	30,400	47,400	59,400
	kW	8.9	13.9	17.4
Power consumption	kW	0.359	0.548	0.638
Casing		Galvanised steel plate		
Dimensions (HxWxD)		470X744X1,100		470X1,380X1,100
Fan	Motor output	0.380		
	Airflow rate	ℓ/s	300	466
		m ³ /min	18	28
External static pressure	240 V	Pa	225	275
Air filter		*2		
Refrigerant piping	Liquid	mm	φ 9.5 (flare)	
	Gas	mm	φ 15.9 (flare)	φ 19.1 (brazing)
	Drain	mm	PS1B female thread	
Machine weight	kg	86	123	
Sound level *3	240 V	dB(A)	43	48
Connectable outdoor units *4		6 class and above	8 class and above	10 class and above
Operation range (Fan mode operation between 15 and 19°C)	Cooling	19 to 43°C		
	Heating	-5 to 15°C		
Range of the discharge temperature *5	Cooling	13 to 25°C		
	Heating	18 to 30°C		

Note: *1. Specifications are based on the following conditions:
 • Cooling: Outdoor temp. of 33°CDB, 28°CWB (68% RH), and discharge temp. of 18°CDB.
 • Heating: Outdoor temp. of 0°CDB, -2.9°CWB (50% RH), and discharge temp. of 25°CDB.
 • Equivalent reference piping length: 7.5 m (0 m horizontal)
 *2. An intake filter is not supplied, so be sure to install the optional long-life filter or high-efficiency filter. Please mount it in the duct system of the suction side. Select a dust collection efficiency (gravity method) of 50% or more.
 *3. Anechoic chamber conversion value, measured at a point 1.5 m downward from the unit centre. These values are normally somewhat higher during actual operation as a result of ambient conditions.
 *4. It is possible to connect to the outdoor unit if the total capacity of the indoor units is 50% to 100% of the capacity index of the outdoor unit.
 *5. Local setting mode. Not displayed on the remote controller.
 • This equipment cannot be incorporated into the remote group control of the VRV system.

Options

Indoor unit

Model		FXMQ125MFV1	FXMQ200MFV1	FXMQ250MFV1	
Operation/control	Operation remote controller	BRC1E63 / BRC2E61			
	Central remote controller	DCS302CA61			
	Unified ON/OFF controller	DCS301BA61			
	Schedule timer	DST301BA61			
	Wiring adaptor for electrical appendices (1)	KRP2A61			
Wiring adaptor for electrical appendices (2)	KRP4AA51				
Filters	Long-life replacement filter	KAFJ371L140	KAFJ371M280		
	High-efficiency filter	Colourimetric method 65%	KAFJ372L140	KAFJ372M280	
		Colourimetric method 90%	KAFJ373L140	KAFJ373M280	
	Filter chamber *1	KDJ3705L140	KDJ3705L280		
PM2.5 filtration unit *2	BAF429A20A				
PM2.5 with activated carbon filtration unit *2	BAF429A20AC				
Drain pump kit	KDU30L250VE				
Adaptor for wiring	KRP1B61				

Note: *1. Filter chamber has a suction-type flange. (Main unit does not.)
 • Dimensions and weight of the equipment may vary depending on the options used.
 • Some options may not be usable due to the equipment installation conditions, so please confirm prior to ordering.
 *2. Refer to page 168-170 for details.
 • Some options may not be used in combination.
 • Operating sound may increase somewhat depending on the options used.

Dimensions

FXMQ125/200/250MFV1

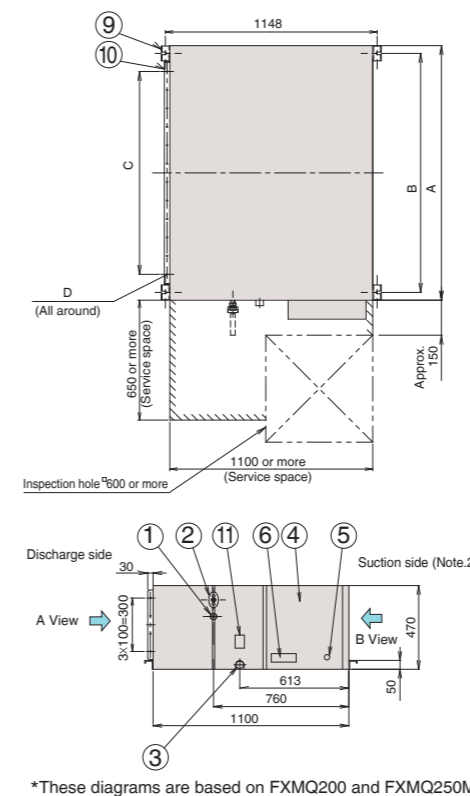

*These diagrams are based on FXMQ200 and FXMQ250MFV1.

Local connection piping size

Model	Gas piping diameter	Liquid piping diameter
FXMQ125MFV1	φ15.9	φ9.5
FXMQ200MFV1	φ19.1 attached piping	φ9.5
FXMQ250MFV1	φ22.2 attached piping	φ9.5

Table of dimensions

Model	A	B	C	D
FXMQ125MFV1	744	685	5X100=500	20-φ4.7 hole
FXMQ200MFV1	1380	1296	11X100=1100	32-φ4.7 hole
FXMQ250MFV1	1380	1296	11X100=1100	32-φ4.7 hole

Note:

- The attached piping in the diagram is for FXMQ200MFV1 and FXMQ250MFV1 only. The gas piping connection port (2) in the diagram has a different bore form with FXMQ125MFV1.
- An air filter is not supplied with this unit. Be sure to mount an air filter in the suction side. [Use a filter with dust collection efficiency of at least 50% (gravimetric method). This is available as an option.]
- For outdoor ducts, be sure to provide heat insulation to prevent condensation.

- ① Liquid pipe connection
- ② Gas pipe connection
- ③ Drain piping connection
- ④ Electric parts box
- ⑤ Ground terminal
- ⑥ Name plate
- ⑦ Power supply wiring connection
- ⑧ Transmission wiring connection
- ⑨ Hanger bracket
- ⑩ Discharge companion flange
- ⑪ Water supply port
- ⑫ Attached piping (Note. 1)

FXMQ200/250MFV1

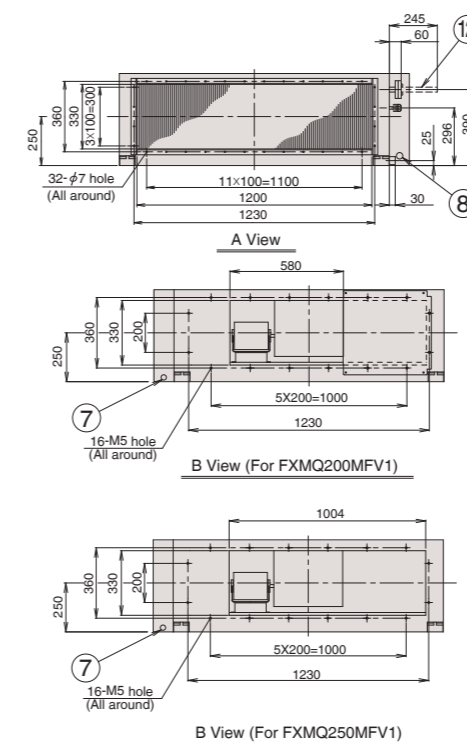

FXMQ125MFV1

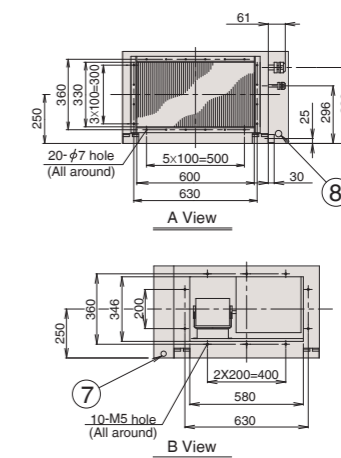

Air Treatment Equipment Lineup

Heat Reclaim Ventilator with DX-Coil and Humidifier – VKM series

The Heat Reclaim Ventilator lineup features the DX-coil in response to recently diversifying outdoor air introduction requirements.

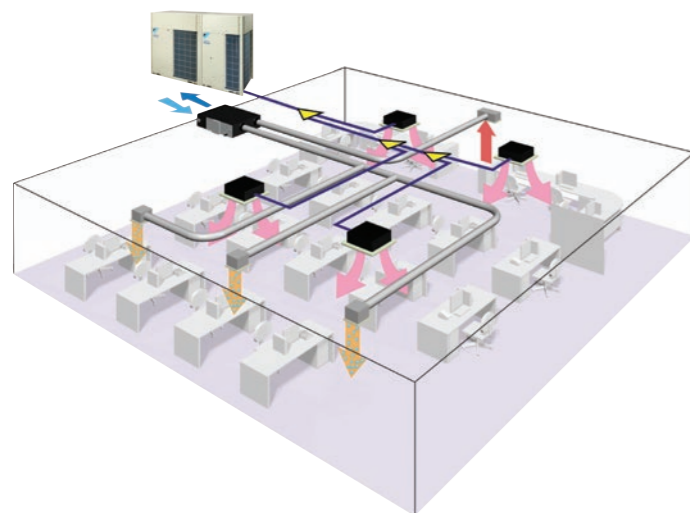

Lineup

With DX Coil & Humidifier Type			
Model Name	VKM50GAMV1	VKM80GAMV1	VKM100GAMV1
Capacity Index	31.25	50	62.5

With DX Coil Type			
Model Name	VKM50GAV1	VKM80GAV1	VKM100GAV1
Capacity Index	31.25	50	62.5



Humidifier

The lineup includes models with a humidifier, in response to diversifying customer requirements. (VKM50/80/100GAMV1 only)

DX-coil

The Heat Reclaim Ventilator features DX-coil that contributes to the prevention of cold airflow hitting people directly during heating operation, due to the after-cool, after-heat operations done beforehand.

High static pressure

High external static pressure means enhanced design flexibility.

Efficient outdoor air introduction is possible

The Heat Reclaim Ventilator (VKM series) series introduces fresh outdoor air with minimum heat losses, while a wide variety of features respond to customer requirements.

Air conditioning and outdoor air processing can be accomplished using a single system.

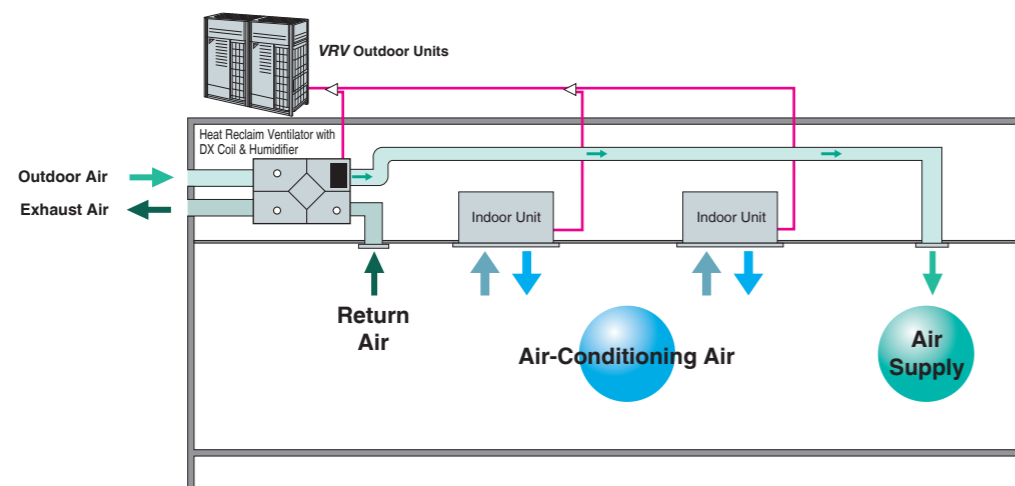

Connection Conditions

The following restrictions must be observed in order to maintain the indoor units connected to the same system.

- When the Heat Reclaim Ventilator VKM series units are connected, the total connection capacity index must be 50% to 130% of the capacity index of the outdoor units.

A compact unit packed with Daikin's cutting-edge technologies

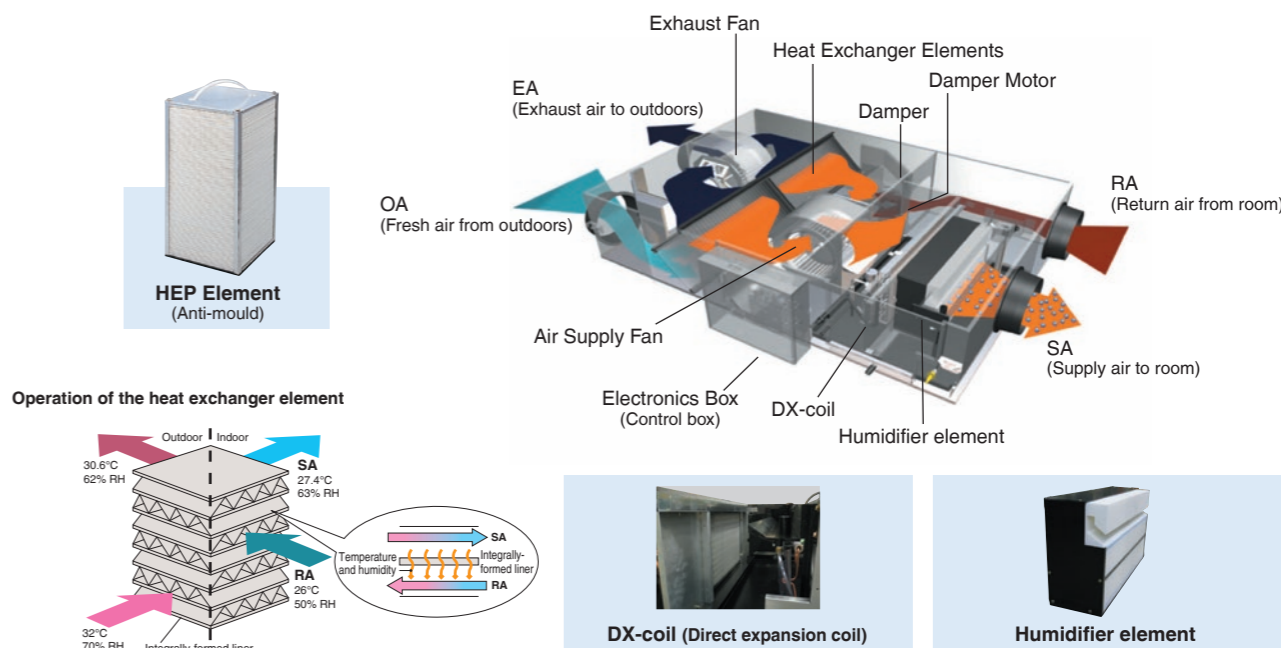

Operation of the heat exchanger element

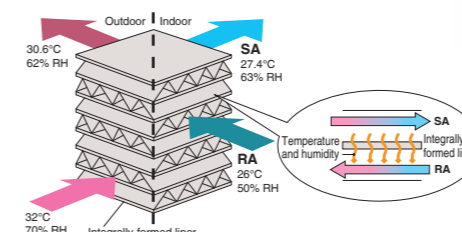

Heating and humidification process

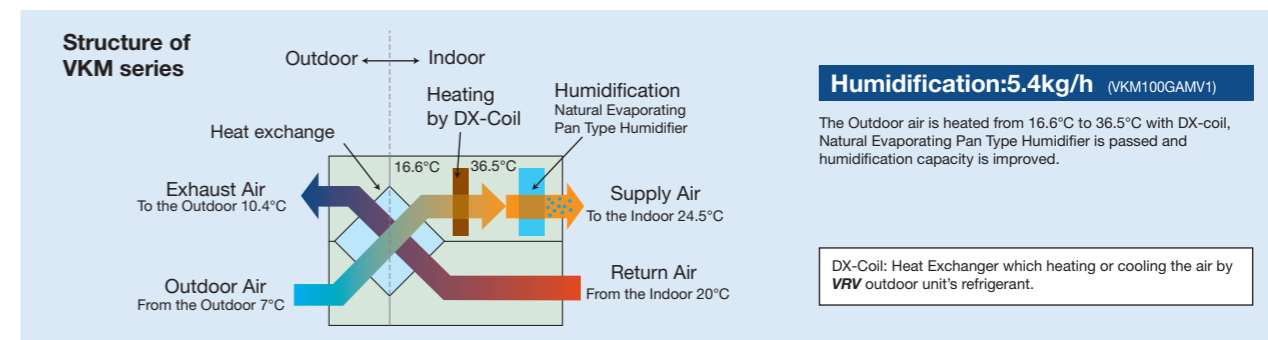

Efficient outdoor air introduction with heat exchanger and cooling/heating operation

Indoor unit with outdoor air treatment

Using outdoor air, the temperature can be brought near room temperature with minimal cooling capacity through the use of outdoor air.

Other features

- Integrated system includes ventilation and humidifying operations.
- Ventilation, cooling/heating and humidifying are possible with one remote controller.

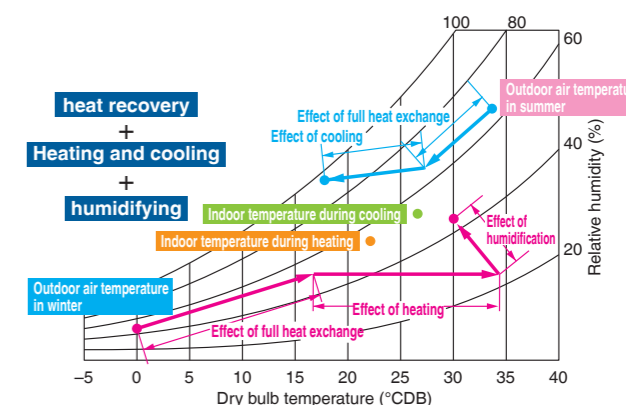

Air Treatment Equipment Lineup

Specifications

MODEL			VKM50GAMV1*	VKM80GAMV1*	VKM100GAMV1*	VKM50GAV1	VKM80GAV1	VKM100GAV1
Refrigerant			R-410A					
Power Supply			1-phase, 220-240 V, 50 Hz					
Airflow Rate & Static Pressure (Note 7)	Ultra-high	Airflow rate (m ³ /h)(ℓ/s)	500/138	750/208	950/263	500/138	750/208	950/263
		Static pressure Pa	160	140	110	180	170	150
	High	Airflow rate (m ³ /h)(ℓ/s)	500/138	750/208	950/263	500/138	750/208	950/263
		Static pressure Pa	120	90	70	150	120	100
	Low	Airflow rate (m ³ /h)(ℓ/s)	440/122	640/177	820/227	440/122	640/177	820/227
		Static pressure Pa	100	70	60	110	80	70
Power Consumption	Heat exchange mode	Ultra-high	560	620	670	560	620	670
		High	490	560	570	490	560	570
		Low	420	470	480	420	470	480
	Bypass mode	Ultra-high	560	620	670	560	620	670
		High	490	560	570	490	560	570
		Low	420	470	480	420	470	480
Fan Type			Sirocco Fan					
Motor Output			kW					
Sound Level (Note 5) (220/230/240 V)	Heat exchange mode	Ultra-high	0.280 x 2	0.280 x 2	0.280 x 2	0.280 x 2	0.280 x 2	0.280 x 2
		High	37/37.5/38	38.5/39/40	39/39.5/40	38/38.5/39	40/41/41.5	40/40.5/41
		Low	32/33/34	33/34/35.5	34/34.5/35.5	33.5/34.5/35.5	34.5/36/37	35/36/36.5
	Bypass mode	Ultra-high	37/37.5/38	38.5/39/40	39/39.5/40	38/38.5/39	40/41/41.5	40/40.5/41
		High	35/35.5/36	36/37/37.5	37/37.5/38	36/36.5/37	37.5/38/39	38/38.5/39
		Low	32/33/34	33/34/35.5	34/34.5/35.5	33.5/34.5/35.5	34.5/36/37	35/36/36.5
Humidification Capacity (Note 4)			kg/h					
Temp. Exchange Efficiency	Ultra-high	%	76	78	74	76	78	74
	High	%	76	78	74	76	78	74
	Low	%	77.5	79	76.5	77.5	79	76.5
Enthalpy Exchange Efficiency (Cooling)	Ultra-high	%	64	66	62	64	66	62
	High	%	64	66	62	64	66	62
	Low	%	67	68	66	67	68	66
Enthalpy Exchange Efficiency (Heating)	Ultra-high	%	67	71	65	67	71	65
	High	%	67	71	65	67	71	65
	Low	%	69	73	69	69	73	69
Casing			Galvanised Steel Plate					
Insulating Material			Self-Extinguishable Urethane Foam					
Heat Exchanging System			Air to Air Cross Flow Total Heat (Sensible + Latent Heat) Exchange					
Heat Exchanger Element			Specially Processed Nonflammable Paper					
Air Filter			Multidirectional Fibrous Fleeces					
DX-coil Capacity	Cooling (Note 2)	kW	2.8	4.5	5.6	2.8	4.5	5.6
	Heating (Note 3)	kW	3.2	5.0	6.4	3.2	5.0	6.4
Dimensions	Height	mm	387	387	387	387	387	387
	Width	mm	1,764	1,764	1,764	1,764	1,764	1,764
	Depth	mm	832	1,214	1,214	832	1,214	1,214
	Connection Duct Diameter	mm	φ200	φ250	φ250	φ200	φ250	φ250
Machine Weight	Net	kg	102	120	125	96	109	114
	Gross (Note 8)	kg	107	129	134	—	—	—
Unit Ambient Condition	Around Unit		0°C-40°CDB, 80%RH or less					
	OA (Note 9)		-15°C-40°CDB, 80%RH or less					
	RA (Note 9)		0°C-40°CDB, 80%RH or less					

Note: 1. Cooling and heating capacities are based on the following conditions. Fan is based on High and Ultra-high.
When calculating the capacity as indoor units, use the following figures:
VKM50GAMV1/GV1: 3.5 kW, VKM80GAMV1/GV1: 5.6 kW, VKM100GAMV1/GV1: 7.0 kW
2. Indoor temperature: 27°CDB, 19°CWB, Outdoor temperature: 35°CDB
3. Indoor temperature: 20°CDB, Outdoor temperature: 7°CDB, 6°CWB
4. Humidifying capacity is based on the following conditions:
Indoor temperature: 20°CDB, 15°CWB, Outdoor temperature: 7°CDB, 6°CWB
5. The operating sound measured at the point 1.5 m below the centre of the unit is converted to that measured in an anechoic chamber built in accordance with the JIS C 1502 conditions. The actual operating sound varies depending on the surrounding conditions (near running unit's sound, reflected sound and so on) and is normally higher than this value.
For operation in a quiet room, it is required to take measures to lower the sound.
For details, refer to the Engineering Data.
6. The noise level at the air discharge port is about 8-11 dB(A) or higher than the unit's operating sound.
For operation in a quiet room, it is required to take measures to lower the sound.
7. Airflow rate can be changed over to Low mode or High mode.
8. In case of holding full water in humidifier.
9. OA: fresh air from outdoor. RA: return air from room.
10. Specifications, design and information here are subject to change without notice.
11. Power consumption and efficiency depend on the above value of airflow rate.

12. Temperature exchange efficiency is the mean value for Cooling and Heating. Efficiency is measured under the following condition: Ratio of rated external static pressure outdoor to indoor is kept constant at 7 to 1.
13. In heating operation, freezing of the outdoor unit's coil increases. Heating capability decreases and the system goes into defrost operation. During defrost operation, the fans of the unit continues driving (factory setting). The purpose of this is to maintain the amount of ventilation and humidifying.
14. When connecting with a VRV system heat recovery outdoor unit and bringing the RA (exhaust gas intake) of this unit directly in from the ceiling, connect to a BS unit identical to the VRV indoor unit (master unit), and use group-linked operation. (See the Engineering Data for details.)
15. When connecting the indoor unit directly to the duct, always use the same system on the indoor unit as with the outdoor unit, perform group-linked operation, and make the direct duct connection settings from the remote controller. (Mode No. "17 (27)" - First code No. "5" - Second code No. "6".) Also, do not connect to the outlet side of the indoor unit. Depending on the fan strength and static pressure, the unit might back up.
* Feed clean water (city water, tap water or equivalent). Dirty water may clog the valve or cause dirt deposits in the water container, resulting in poor humidifier performance. (Never use any cooling tower water and heating-purpose water.)
Also, if the supply water is hard water, use a water softener because of short life.
* Life of humidifying element is about 3 years (4,000 hours) under the supply water conditions of hardness: 150 mg/l. (Life of humidifying element is about 1 year (1,500 hours) under the supply water conditions of hardness: 400 mg/l.)
Annual operating hours: 10 hours/day x 26 days/month x 5 months = 1,300 hours

Dimensions

VKM50/80/100GA(M)V1

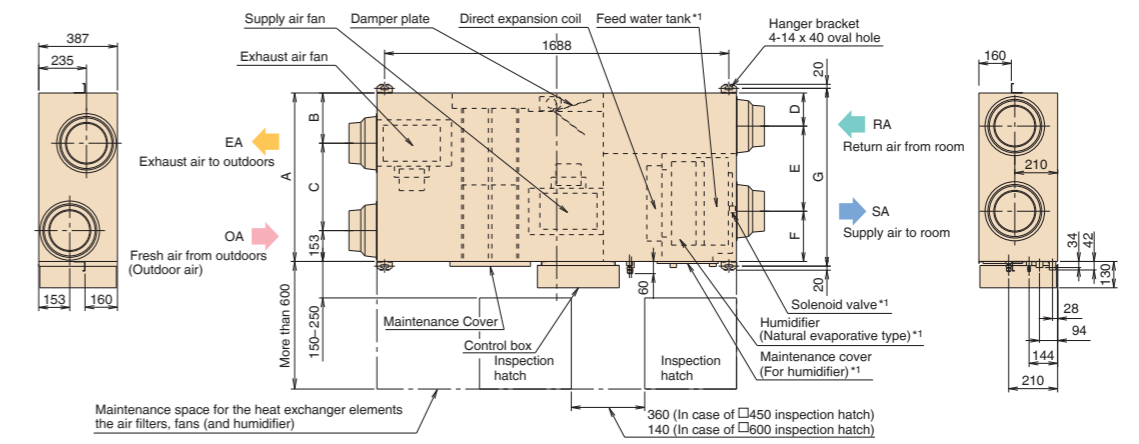

	VKM50GA(M)V1	VKM80/100GA(M)V1
A	832	1,214
B	248	439
C	431	622
D	164	183
E	420	592
F	248	439
G	878	1,262
H	137	89
I	137	89
J	φ196	φ246
K	φ250	φ263

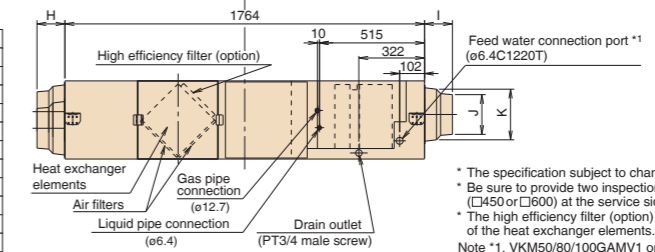

* The specification subject to change without notice.
* Be sure to provide two inspection hatch. (□450 or □360) at the service side of filters and elements.
* The high efficiency filter (option) can be attached to the SA surface of the heat exchanger elements.
Note *1. VKM50/80/100GAMV1 only.

Options

Item	Type	VKM50/80/100GA(M)V1
Remote controller		BRC1E63 / BRC2E61 *1
Centralised controlling device	Residential central remote controller	DCS303A51 *2
	Central remote controller	DCS302CA61
	Unified ON/OFF controller	DCS301BA61
	Schedule timer	DST301BA61
Wiring adaptor for electrical appendices		KRP2A61
	For humidifier running ON signal output	KRP50-2
For wiring	For heater control kit	BRP4A50
	Type (indoor unit of VRV)	FXFSQ-A FXFQ-P FXZQ-A2 FXUQ-A FXCQ-A FXEQ-A FXDQ-PD FXDQ-ND FXDQ-T FXSQ-PA FXDQ-MA FXMQ-PA FXMQ-P FXHQ-MA FXHQ-A FXAQ-A FXLQ-MA FXNQ-MA
Installation box for adaptor PCB ☆	Note 2, 3 KRP1H98A Note 4, 5 KRP1BA101 KRP1BA91 Note 2, 3 KRP1B96 - Note 4 KRP1BA101 BRP9A90 Note 2, 3 KRP4A98 - Note 2, 3 KRP1C64* KRP1B61 KRP1C64* KRP1C67* KRP1BA54 - KRP1B61	

Note: 1. Installation box ☆ is necessary for each adaptor marked ☆.
2. Up to 2 adaptors can be fixed for each installation box.
3. Only one installation box can be installed for each indoor unit.
4. Up to 2 installation boxes can be installed for each indoor unit.
5. *1 Necessary when operating a Heat Reclaim Ventilator (VKM) independently. When operating interlocked with other air conditioners, use the remote controllers of the air conditioners.
*2 For residential use only. When connected with a Heat Reclaim Ventilator (VKM), you can only switch the power ON/OFF. Cannot be used with other centralised control equipment.

Item	Type	VKM50GA(M)V1	VKM80GA(M)V1	VKM100GA(M)V1
Silencer		—	—	KDDM24B100
	Nominal pipe diameter	mm	—	φ250
Air suction/ Discharge grille	White	K-DGL200B	—	K-DGL250B
	Nominal pipe diameter	mm	φ200	φ250
High efficiency filter		KAF242J80M	—	KAF242J100M
Air filter for replacement		KAF241G80M	—	KAF241G100M
Flexible duct (1 m)		K-FDS201D	—	K-FDS251D
Flexible duct (2 m)		K-FDS202D	—	K-FDS252D

Air Treatment Equipment Lineup

Heat Reclaim Ventilator – VAM series

The Heat Reclaim Ventilator creates a high-quality environment by interlocking with the air conditioner

Model Names

VAM150GJVE, VAM250GJVE, VAM350GJVE,
VAM500GJVE, VAM650GJVE, VAM800GJVE,
VAM1000GJVE, VAM1500GJVE, VAM2000GJVE

Improved Enthalpy Efficiency*¹
Higher External Static Pressure*²
Enhanced Energy Saving Functions

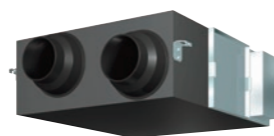

Heat Reclaim Ventilator remote controller*
BRC301B61 (Option)

* This remote controller is used in case of independent operation of Heat Reclaim Ventilator.

This VAM series provides higher enthalpy efficiency*¹, due to the greatly enhanced performance of the thin film element. Furthermore, improved external static pressure*² offers more flexibility for installation. Along with these three outstanding improvements, the nighttime free cooling operation contributes to energy conservation and more comfortable space.

*¹ For models: VAM150/250/350/650/800/1000/2000GJVE
*² For models: VAM150/350/500GJVE

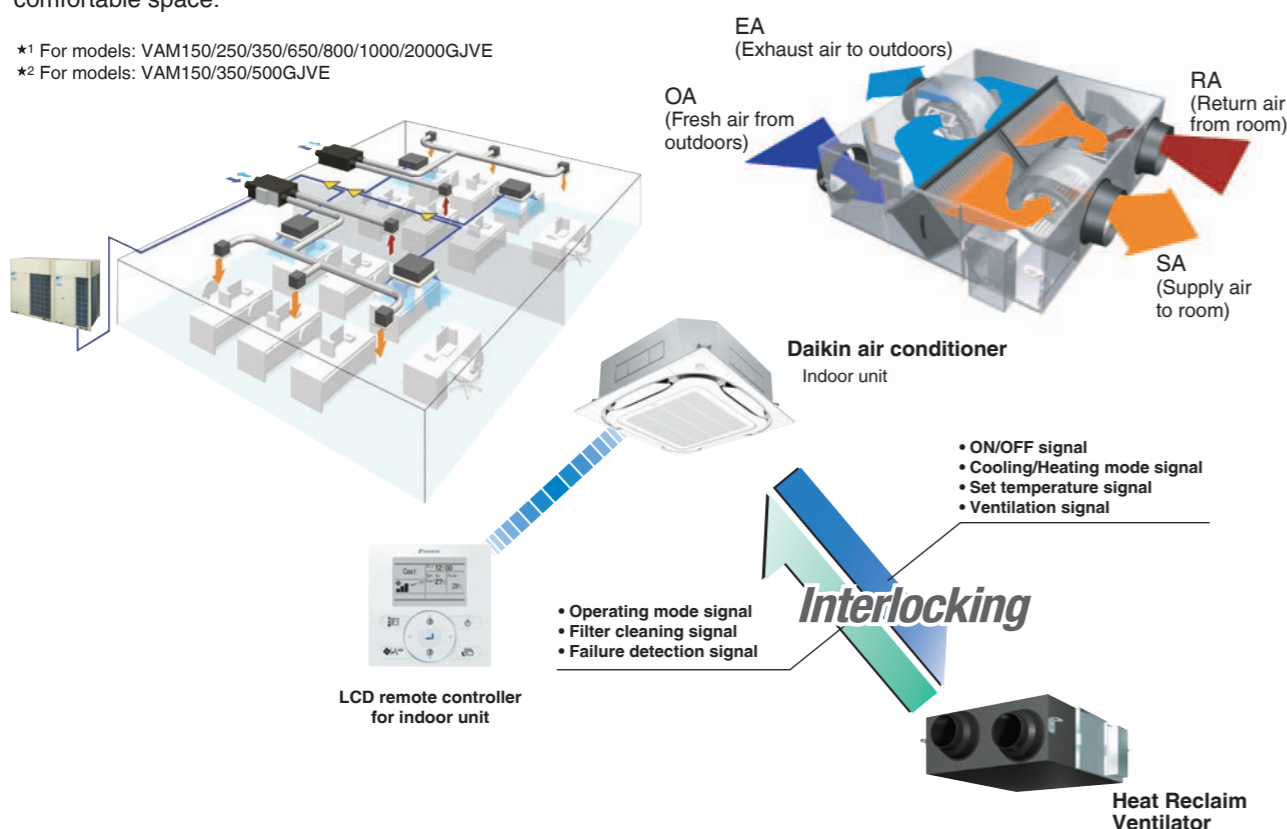

Compact Equipment

With a height of just 306 mm, the unit easily fits in limited spaces, such as above ceilings.

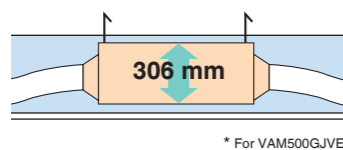

Energy Conservation

Air conditioning load reduced by approximately 31%!

Cold Climate Compatible

Standard operation at temperatures down to -15°C.



Air conditioning load reduced by approximately 31%!

Total heat exchange ventilation

This unit recovers heat energy lost through ventilation and curbs room temperature changes caused by ventilation, thereby conserving energy and reducing the load on the air conditioning system.

Enthalpy efficiency drastically improved by employing thin film element! (VAM-GJ model)

Due to the thinner film...

- Decreases the moisture resistance of the partition sheets drastically.
- Realises more space for extra layers in the element, resulting in increased effective area that supply and exhaust air can be exposed to.

Moisture absorption increased by approx. 10%!

23%

Auto-ventilation Mode Changeover Switching

Automatically switches the ventilation mode (Total Heat Exchange Mode/Bypass Mode) according to the operating status of the air conditioner.

6%

+

Pre-cool, Pre-heat Control

Reduces air conditioning load by not running the Heat Reclaim Ventilator while air is still clean soon after the air conditioner is turned ON.

2%

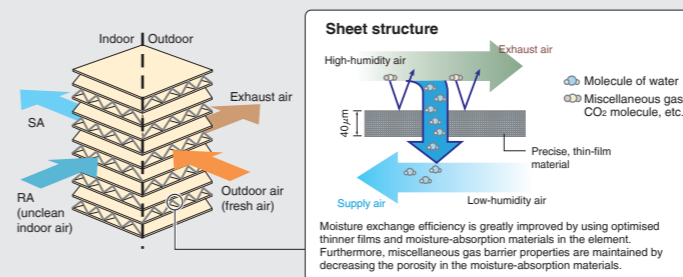

Thickness of the partition sheet
40 µm

- The air conditioning load reduction values may vary according to weather and other environmental conditions at the location of the machine's installation.
- The air conditioning load reduction values are based on the following conditions:
Application: Tokyo office building
Building form: 6 floors above ground, 2 floors underground, floor area 2,100 m²
Personnel density: 0.25 person/m²
Ventilation volume: 25 m³/h
Indoor air conditioning level: summer 25°C 50% RH, intermediate seasons 24°C 50% RH, winter 22°C 40% RH
Operating time: 2745 hours (9 hours per day, approx. 25 days per month)
Calculation method: simulation based on "MICRO-HASP/1982" of the Japan Building Mechanical and Electrical Engineers Association.

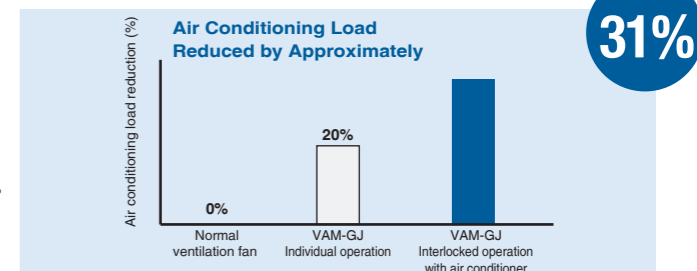

Nighttime free cooling operation*¹

Nighttime free cooling operation is an energy-conserving function that works at night when air conditioners are off. By ventilating rooms containing office equipment that raises the room temperature, nighttime free cooling operation reduces the cooling load when air conditioners are turned on in the morning. It also alleviates feelings of discomfort in the morning caused by heat accumulated during the night.

- Nighttime free cooling operation only works to cool and if connected to Building Multi or VAV systems.
- Nighttime free cooling operation is set to "off" in the factory settings, so if you wish to use it, request your dealer to turn it on.

*¹ This function can be operated only when interlocked with air conditioners.
*² Value is based on the following conditions:
• Cooling operation performed from April to October.
• Calculated for air conditioning sensible heat load only (latent heat load not included).

Air conditioning sensible heat load reduced by approx. 5%*²!

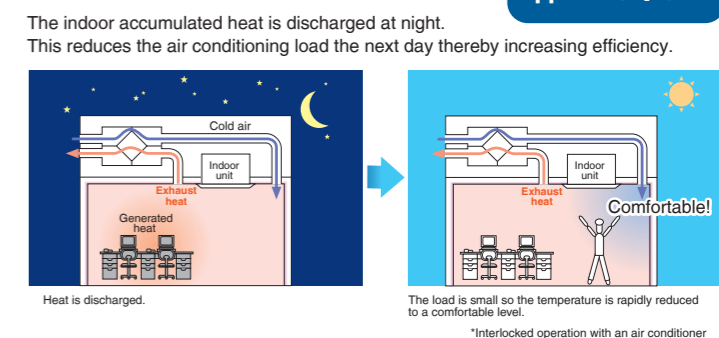

Air Treatment Equipment Lineup

Heat Reclaim Ventilator – VAM series

CO₂ Sensor Optional Kit Connection

The CO₂ sensor controls airflow so that it best matches the changes in CO₂ level. This prevents energy losses from over-ventilation while maintaining indoor air quality with optional CO₂ sensor.

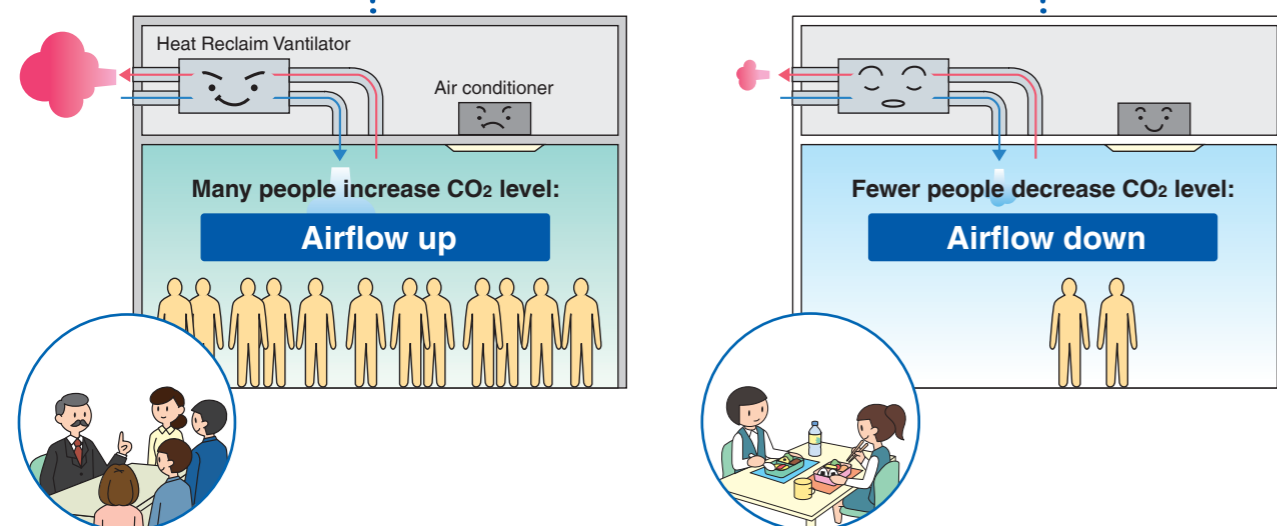
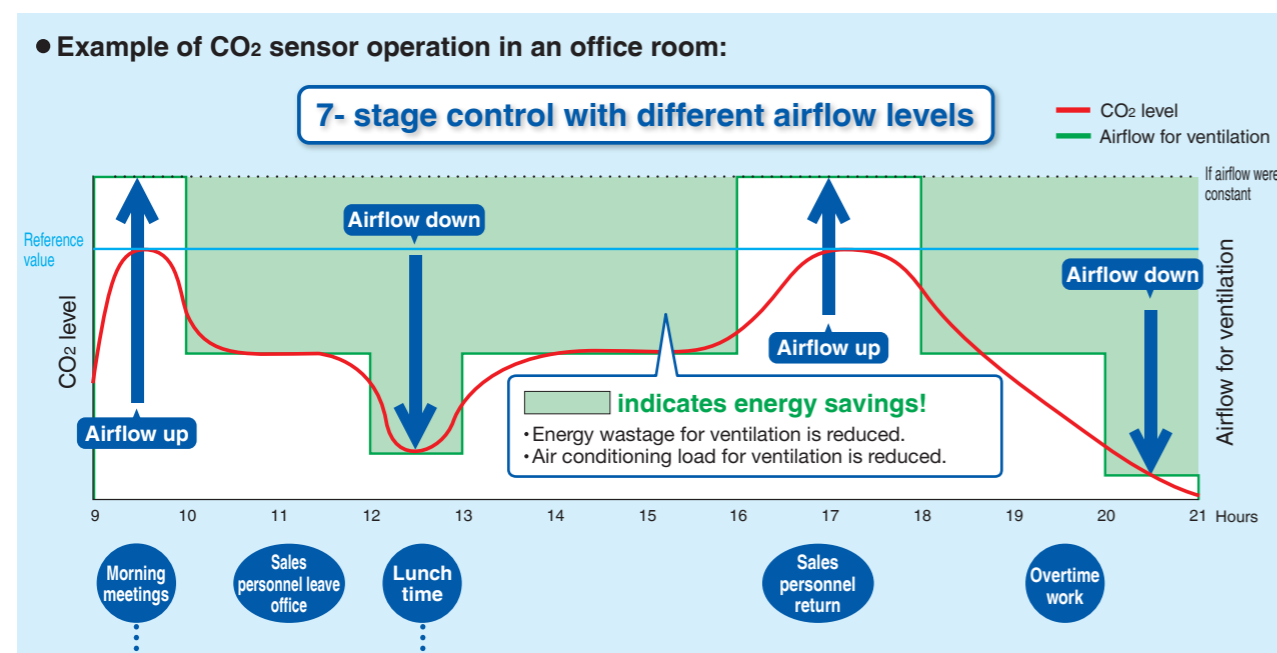

Specifications

MODEL		VAM150GJVE	VAM250GJVE	VAM350GJVE	VAM500GJVE	VAM650GJVE	VAM800GJVE	VAM1000GJVE	VAM1500GJVE	VAM2000GJVE			
Power Supply		1-phase, 220-240 V/220 V, 50/60 Hz											
Temp. Exchange Efficiency	Ultra-High	79	75	79	74	75	72	78	72	77			
	High	79	75	79	74	75	72	78	72	77			
	Low	84	79	82	80	77	74	80.5	75.5	79			
Enthalpy Exchange Efficiency	For Heating	Ultra-High	72	71	70	67	67.5	65	70	65	72		
		High	72	71	70	67	67.5	65	70	65	72		
		Low	76	74	77	74	71.5	67.5	72.5	67	75		
	For Cooling	Ultra-High	66	63	66	55	61	61	64	61	62		
		High	66	63	66	55	61	61	64	61	62		
		Low	70	66	70	59	64	64	68.5	64	66		
Power Consumption	Heat Exchange Mode	Ultra-High	125	137	200	248	342	599	635	1,145	1,289		
		High	111	120	182	225	300	517	567	991	1,151		
		Low	57	60	122	128	196	435	476	835	966		
	Bypass Mode	Ultra-High	125	137	200	248	342	599	635	1,145	1,289		
		High	111	120	182	225	300	517	567	991	1,151		
		Low	57	60	122	128	196	435	476	835	966		
Sound Level	Heat Exchange Mode	Ultra-High	27-28.5	27-29	31.5-33	33-35.5	34-36	39-40.5	39.5-41.5	39.5-41.5	41.5-43.5		
		High	26-27.5	26-27.5	30-31.5	31.5-34	33-34.5	37-39.5	37.5-39.5	37.5-39.5	39-43		
		Low	20.5-21.5	21-22	23-25	25-28.5	27.5-29.5	35-37.5	35-37.5	35-37.5	36-39		
	Bypass Mode	Ultra-High	28.5-29.5	28.5-30.5	33-34.5	34.5-36	35-37.5	40.5-42	40.5-42.5	41-43	43-45.5		
		High	27.5-28.5	27.5-29	31.5-33	33-34.5	33-35.5	38.5-40	38.5-40.5	39.5-41	40.5-45		
		Low	22.5-23.5	22.5-23	24.5-26.5	25.5-28.5	27.5-30.5	36-38.5	36-38.5	36.5-38	37.5-39.5		
Casing		Galvanised steel plate											
Insulation Material		Self-extinguishable polyurethane foam											
Dimensions (HXWXD)		mm	278x810x551	306x879x800	338x973x832	387x1,111x832	387x1,111x1,214	785x1,619x832	785x1,619x1,214				
Machine Weigh		kg	24	32	45	55	67	129	157				
Heat Exchange System		Air to air cross flow total heat (Sensible heat + latent heat) exchange											
Heat Exchange Element Material		Specially processed nonflammable paper											
Air Filter		Multidirectional fibrous fleeces											
Fan	Airflow Rate	Type	Sirocco fan										
			m ³ /h	Ultra-High	150	250	350	500	650	800	1,000	1,500	2,000
				High	150	250	350	500	650	800	1,000	1,500	2,000
		Low		100	155	230	320	500	700	860	1,320	1,720	
		ℓ/s	Ultra-High	41	69	97	138	180	222	277	416	555	
			High	41	69	97	138	180	222	277	416	555	
	Low		27	43	63	88	138	194	238	366	477		
	External Static Pressure	Pa	Ultra-High	120	70	169	105	85	133	168	112	116	
			High	106	54	141	66	53	92	110	73	58	
			Low	56	24	67	32	35	72	85	56	45	
	Motor Output		kW	0.030x2		0.090x2		0.140x2		0.280x2		0.280x4	
	Connection Duct Diameter		mm	φ 100	φ 150	φ 200		φ 250		φ 350			
Unit Ambient Condition		-15°C~50°CDB, 80%RH or less											

- Note: 1. Sound level is measured at 1.5 m below the centre of the body.
 2. Airflow rate can be changed over to Low mode or High mode.
 3. Sound level is measured in an anechoic chamber. Sound level generally becomes greater than this value depending on the operating conditions, reflected sound, and peripheral noise.
 4. The sound level at the air discharge port is about 8 dB(A) higher than the unit's sound level.
 5. The specifications, designs and information given here are subject to change without notice.
 6. Temperature Exchange Efficiency is the mean value between cooling and heating.
 7. Efficiency is measured under the following conditions: Ratio of rated external static pressure has been maintained as follows; outdoor side to indoor side = 7 to 1.
 8. In conformance with JIS standards (JIS B 8628), operating sound level is based on the value when one unit is operated, with the value converted for an anechoic chamber. This is transmission sound from the main unit, and does not include sound from the discharge grille. Thus it is normal for the sound to be louder than the indicated value when the unit is actually installed.
 9. Sound level from the discharge port causes the value to be approximately 8 dB(A) (models with the airflow rate of less than 150 to 500 m³/h) to approximately 11 dB(A) (models with the airflow rate of 650 m³/h or more) greater than the indicated value. Furthermore, fan rotation and noise from the discharge grille may increase depending on the on-site duct resistance conditions. Please consider noise countermeasures when installing the unit.
 10. With large models in particular (1500 and 2000 m³/h models), if the supply air (SA) grille is installed near the main unit, the noise of the main unit may be heard from the discharge grille via the duct, and this will result in a marked increase in noise. In such cases, if peripheral effects are included (such as reverberation of the floor and walls, combination with other equipment, and background noise), sound level may be as much as 15 dB(A) higher than the indicated value. When installing a large model, please provide as much separation as possible between the main unit and the discharge grille. If the equipment and discharge grille are near each other, please consider countermeasures such as the following:
 • Use a sound-muffling box, flexible duct and sound-muffling air supply/discharge grilles
 • Decentralised installation of discharge grilles
 11. When installing in a location with particularly low background noise such as a classroom, please consider the following measures to avoid transmission sound from the main unit:
 • Use of ceiling materials with high sound insulating properties (high transmission loss)
 • Methods of blocking sound transmission, for example, by adding sound insulating materials around the bottom of the sound source.
 Alternatively, consider supplementary methods such as installing the equipment in a different location (corridor, etc.)

Air Treatment Equipment Lineup

Options

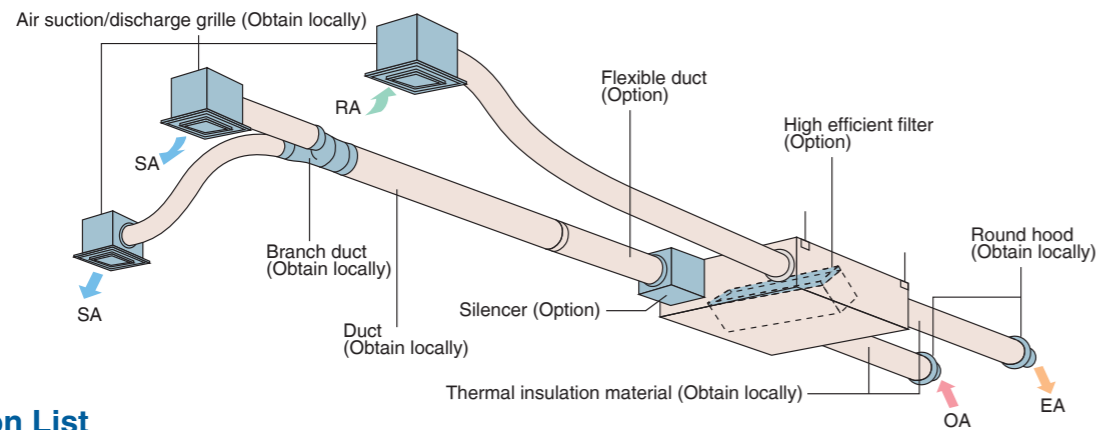

Option List

Item	Type	VAM150 · 250 · 350 · 500 · 650 · 800 · 1000 · 1500 · 2000GJVE																	
Controlling device	Heat Reclaim Ventilator remote controller	BRC301B61																	
	Centralised controlling device	Residential central remote controller	DCS303A51 Note 1																
		Central remote controller	DCS302CA61																
		Unified ON/OFF controller	DCS301BA61																
		Schedule timer	DST301BA61																
PC Board Adaptor	Wiring adaptor for electrical appendices	KRP2A61																	
	For humidifier	KRP50-2																	
	Installation box for adaptor PCB	KRP50-2A90 (Mounted electric component assy of Heat Reclaim Ventilator)																	
	For heater control kit	BRP4A50																	
	For wiring	Type (indoor unit of VRV)	FXFSQ-A	FXFQ-P	FXZQ-A2	FXUQ-A	FXCQ-A	FXEQ-A	FXDQ-PD	FXDQ-ND	FXDQ-T	FXSQ-PA	FXDQ-MA	FXMQ-PA	FXMQ-P	FXHQ-MA	FXHQ-A	FXAQ-A	FXLQ-MA
Installation box for adaptor PCB*		KRP1C11A*	KRP1C63*	KRP1B67*	-	KRP1B61*	-	KRP1B56*	KRP1C64*	KRP1B61	KRP1C64*	KRP1C67*	KRP1BA54	-	KRP1B61				
	Note 2, 3	KRP1H98A																	

Note: 1. Installation box * is necessary for each adaptor marked *.
 2. Up to 2 adaptors can be fixed for each installation box.
 3. Only one installation box can be installed for each indoor unit.
 4. Up to 2 installation boxes can be installed for each indoor unit.
 5. *1 Necessary when operating a Heat Reclaim Ventilator (VKM) independently. When operating interlocked with other air conditioners, use the remote controllers of the air conditioners.

Item	Type	VAM150GJVE	VAM250GJVE	VAM350GJVE	VAM500GJVE	VAM650GJVE	VAM800GJVE	VAM1000GJVE	VAM1500GJVE	VAM2000GJVE
Additional function	Silencer				KDDM24B50		KDDM24B100		KDDM24B100X2	
	Nominal pipe diameter				φ 200		φ 250		φ 250	
	High efficiency filter	KAF242J25M		KAF242J50M	KAF242J65M	KAF242J80M	KAF242J100M	KAF242J80MX2	KAF242J100MX2	
Air filter for replacement	KAF241J25M		KAF241H50M	KAF241J65M	KAF241J80M	KAF241J100M	KAF241J80MX2	KAF241J100MX2		
Flexible duct (1 m)	K-FDS101D	K-FDS151D		K-FDS201D				K-FDS251D		
Flexible duct (2 m)	K-FDS102D	K-FDS152D		K-FDS202D				K-FDS252D		
Duct adaptor	Nominal pipe diameter							YDFA25A1		
								φ 250		
CO ₂ sensor		BRYMA65					BRYMA100	BRYMA65	BRYMA100	
PM2.5 filtration unit*		BAF249A150	BAF249A300	BAF249A350	BAF249A500			BAF429A20A		
PM2.5 with activated carbon filtration unit*		BAF249A150C	BAF249A300C	BAF249A350C	BAF249A500C			BAF429A20AC		

*Refer to page 168-170 for details.

PC board adaptor for heater control kit (BRP4A50)

When the installation of an electric heater is required in a cold region, this adaptor with an internal timer function eliminates the complicated timer connecting work that was necessary with conventional heaters.

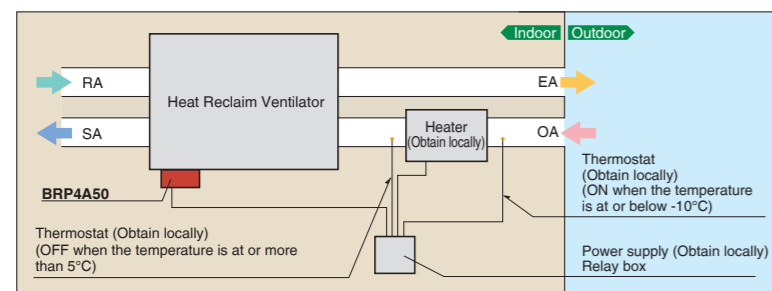

Note when installing

- Examine fully an installation place and specification for using the electric heater based on the standard and regulation of each country.
- Supply the electric heater and safety production devices such as a relay and a thermostat, etc of which qualities satisfy the standard and regulation of each country at site.
- Use a non-inflammable connecting duct to the electric heater. Be sure to allow 2 m or more between the electric heater and the Heat Reclaim Ventilator for safety.
- For the Heat Reclaim Ventilator, use a different power supply from that of the electric heater and install a circuit breaker for each.

PM2.5 filtration unit (Option) for VAM / FXMQ-MF series

Rapid urbanization has increased industrial and automobile emissions, resulting in higher PM2.5 levels. This has become the source of respiratory diseases and poses a serious threat to a long term health issue. As the air quality has worsened, research has shown the harmful effects of PM2.5 on the health of the general public.

Double-layered efficient filtration

PM2.5 filters are double-layered.

- The front filter effectively removes large particles.
- The PM2.5 filter layer contains a large amount of static electricity to capture particulate matter efficiently.

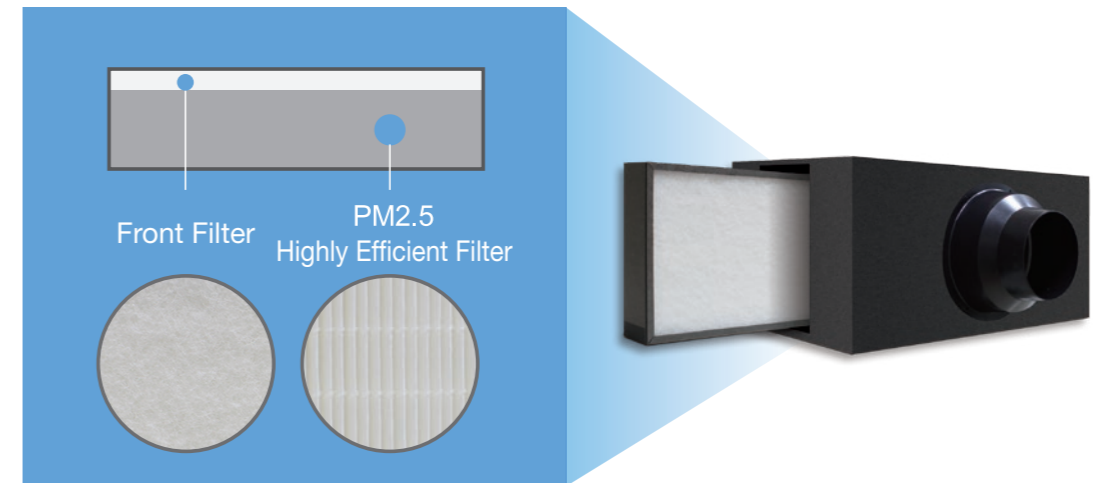

Electrostatic dust collection filter: more efficient and longer lasting effect

The PM2.5 filter layer contains a large amount of static electricity to capture particulate matter efficiently, including those smaller than the grid mesh.

The filter is difficult to be blocked by particles and has good ventilation and long life span.

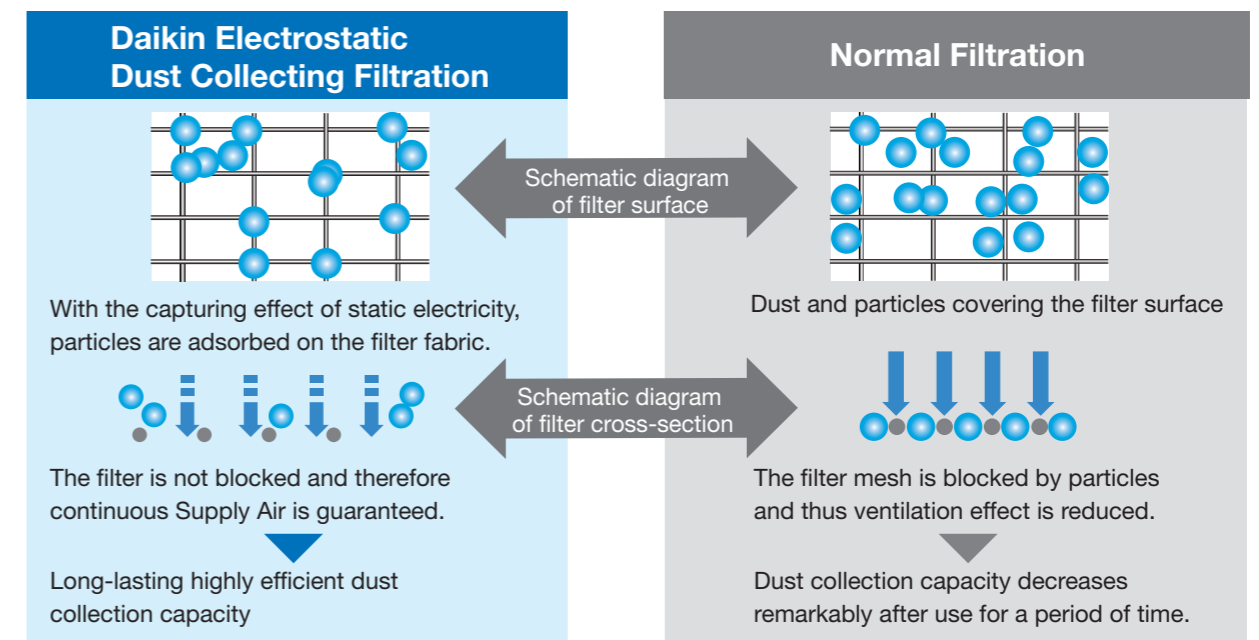

Air Treatment Equipment Lineup

PM2.5 filtration unit (Option) for VAM / FXMQ-MF series

Filtering PM2.5 efficiently for healthier and more comfortable environments

The PM2.5 filtering series heat reclaim ventilator is equipped with an electrostatic dust collection filter for PM2.5 removal. This filter removes 99% or more of 2.5 μm.

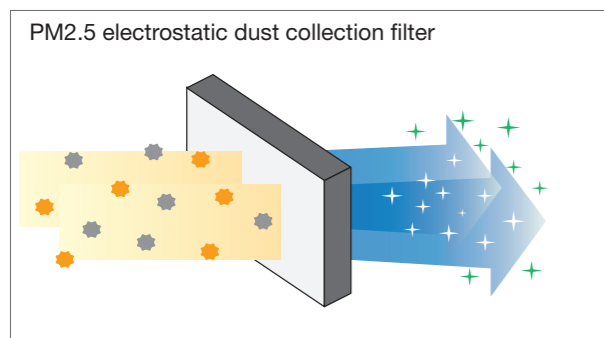

*Test results by the Heating, Ventilation and Air Conditioning Lab at Tongji University
Test environment: temperature 25-26°CDB, humidity 58-60%RH

Extra-High Performance Filter Against Sulfur Oxides and Nitrogen Oxides

Effective Use of Active Carbon Material to Enlarge the Adsorption Area

As an expert in the research and development of filters, DAIKIN has specifically selected active carbon material as the main substance to constitute the filter against sulfur oxides and nitrogen oxides. The material's usable pore surface is fully exploited, thus extending the filter's durability.

Note: Surface area of active carbon: 700 m²/g
Given a newspaper page of 40.6 cm wide by 54.6 cm long, each gram of active carbon has a surface area of 3,000 newspaper pages.

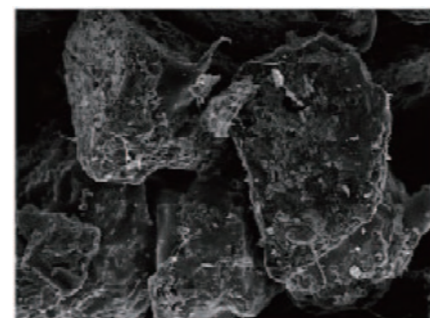

Intelligent Identification, Super-effective Adhesion

The special substance added in the pores of active carbon can exclusively target sulfur oxide and nitrogen oxide gases and stick to them without blocking other unidentified gases. This ensures long durability of the filter.

Note: The figures are based on in-house tests under the following lab conditions: temperature 22 to 25°CDB, humidity 35 to 40% RH, air flow rate 0.2 m/s.

Unidentified Gases

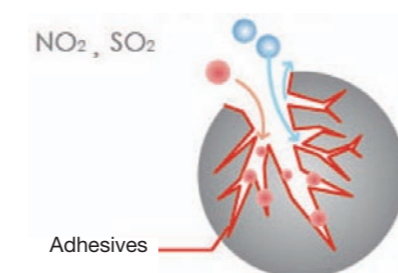

PM2.5 Filtration Unit

Models		BAF249A150	BAF249A300	BAF249A350	BAF249A500	
Heat Reclaim Ventilator Models		VAM150GJVE	VAM250GJVE	VAM350GJVE	VAM500GJVE	
Dimensions (H x W x D)	mm	220 x 603 x 366	220 x 603 x 366	300 x 623 x 366	300 x 623 x 366	
Connection Duct Diameter	mm	Ø100	Ø150	Ø150	Ø200	
Airflow Rate	m ³ /h	150	250	350	500	
PM2.5 Filter	Initial Pressure Drop	Pa	34	30	31	42
	Filter Lifetime ¹		1 year			
	Filtration Efficiency ²		99% or higher			
	Filter Material No. ³		BAF244A300		BAF244A500	

Note: 1. Annual usage: 400 hrs/month x 12 months = 4,800 hrs
2. 99% or higher removal rate of ultra-fine particles with diameters of 2.5 μm or more.
3. Filters come with applicable filtration units with a one-year life. They can be purchased and replaced according to their model numbers.

PM2.5 with Activated Carbon Filtration Unit

Models		BAF249A150C	BAF249A300C	BAF249A350C	BAF249A500C	
Heat Reclaim Ventilator Models		VAM150GJVE	VAM250GJVE	VAM350GJVE	VAM500GJVE	
Dimensions (H x W x D)	mm	220x603x366	220x603x366	300x623x366	300x623x366	
Connection Duct Diameter	mm	Ø100	Ø150	Ø150	Ø200	
Airflow Rate	m ³ /h	150	250	350	500	
PM2.5 Filter	Initial Pressure Drop	Pa	34	30	31	42
	Filter Lifetime ¹		1 year			
	Filtration Efficiency ²		99% or higher			
	Filter Material No. ³		BAF244A300		BAF244A500	
Activated Carbon Filter	Initial Pressure Drop	Pa	3	5	5	9
	Filter Lifetime		1 year			
	Filter Material No. ³		BAF244A300C		BAF244A500C	
Total Initial Pressure Drop for PM2.5 with Activated Carbon Filtration Unit		Pa	37	35	36	51

Note: 1. Annual usage: 400 hrs / month x 12 months = 4,800 hrs.
2. 99% or higher removal rate of ultra-fine particles with diameters of 2.5 μm or more.
3. Filters come with applicable filtration units with a one-year life. They can be purchased and replaced according to their model numbers.

Individual Control Systems for VRV Indoor System

“Nav Ease” (Wired remote controller) (Option)



BRC1E63



BRC1F61
(Only for FXEQ series)

This simple, contemporary remote controller with fresh white colour matches your interior design. The clear, backlight display with large easy-to-read text makes navigation easy and provides one-touch control over your in-home comfort.

Clear display

•Dot matrix display

• A combination of fine dots enables various icons. Large text display is easy to see.

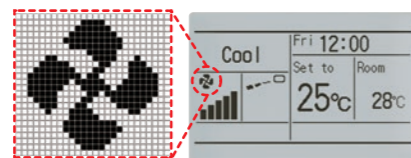

•Backlight display

• Backlight display helps operating in dark rooms.



Simple operation

•Large buttons and arrow keys

• Large buttons and arrow keys enable easy operation. Basic setting such as fan speed and temperature can be intuitively operated. For other settings, select the function from the menu list.

•Guide on display

• The display gives an explanation of each setting for easy operation.

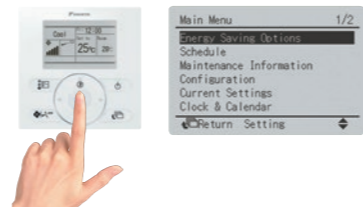

Energy saving

•Setpoint range set

• Saves energy by limiting the min. and max. set temperature.
• Avoids excessive cooling or heating.
• This function is convenient when the remote controller is installed at a place where any number of people may operate it.

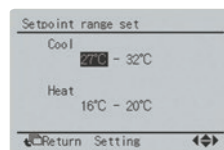

•Off timer

• Turns off the air conditioner after a preset period of time.
• Period can be preset from 30 to 180 minutes in 10-minute increments.

•Setpoint auto reset

• Even if the set temperature is changed, the new set temperature returns to the previous preset value after a preset duration of time.
• Period selectable from 30, 60, 90, or 120 min.

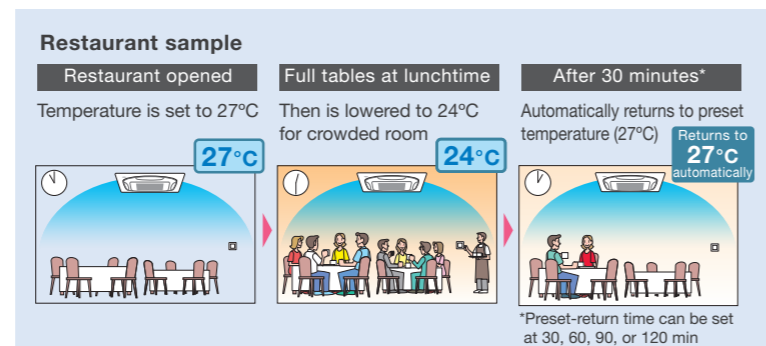
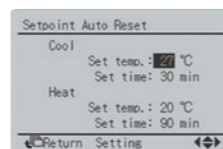

Convenience

•Setback (default: OFF)

Maintains the room temperature in a specific range during unoccupied period by temporarily starting air conditioner that was turned OFF.

Ex) Setback temperature Cooling : 35°C Recovery differential Cooling : -2°C
When the room temperature goes above 35°C, the air conditioner starts operating in Cooling automatically. When room temperature reaches 33°C, the air conditioner returns OFF.

	Setback temperature	Recovery differential
Cooling	33 — 37°C	-2 — -8°C
Heating	10 — 15°C	+2 — +8°C

•Weekly schedule

• 5 actions per day can be scheduled for each day of the week.
• The holiday function will disable schedule timer for the days that have been set as holiday.
• 3 independent schedules can be set. (e.g. summer, winter, mid-season)

Time	Act	Cool	Heat
Mon 8:30	ON	25°C	—
10:00	OFF	—	—
13:00	ON	25°C	—
15:00	OFF	—	—

College classroom sample (a summer Monday case)

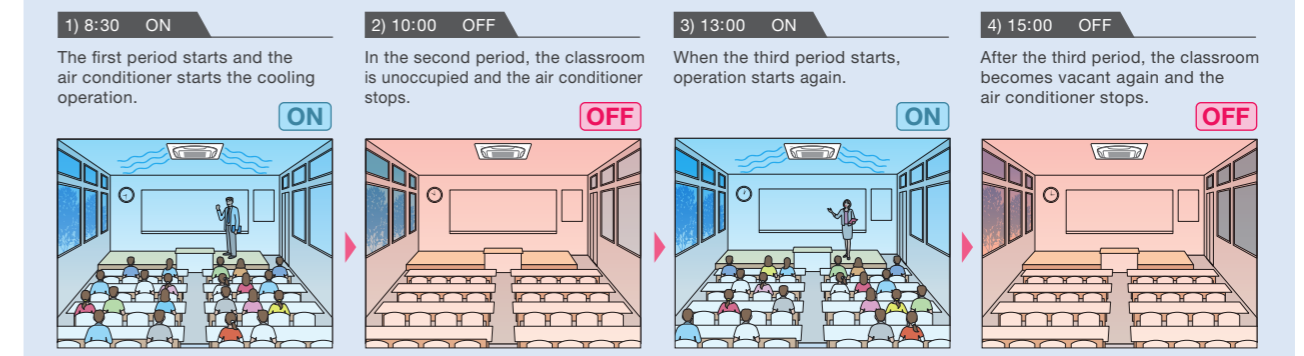

•Auto display off

• While operation is stopping, LCD display can be turned OFF. It will be displayed again if any button is pressed.
• Period can be preset from 10, 30, 60 minutes, and OFF. Initial setting is 30 minutes.

Comfort

•Individual airflow direction (*1)

Airflow direction can be individually adjusted for each air discharge outlet to deliver optimal air distribution that conforms to conditions for airflow direction (small and large loads).

*1. Only available for FXFSQ-A, FXCQ-A and FXUQ-A series.

•5-step airflow control (*2)

Control of airflow rate can be selected from 5-step control, which provides comfortable airflow.

*2. The number of airflow steps differs according to the type of indoor unit. 5-step airflow is only available for FXFSQ-A, FXEQ-A and FXDQ-T series.

•Auto airflow rate (*3)

Airflow rate is automatically controlled in accordance to the difference between room temperature and set temperature.

*3. Only available for FXFSQ-A, FXCQ-A, FXDQ-T/PD/ND, FXSQ-PA, FXMQ-PA, FXUQ-A and FXAQ-A series.

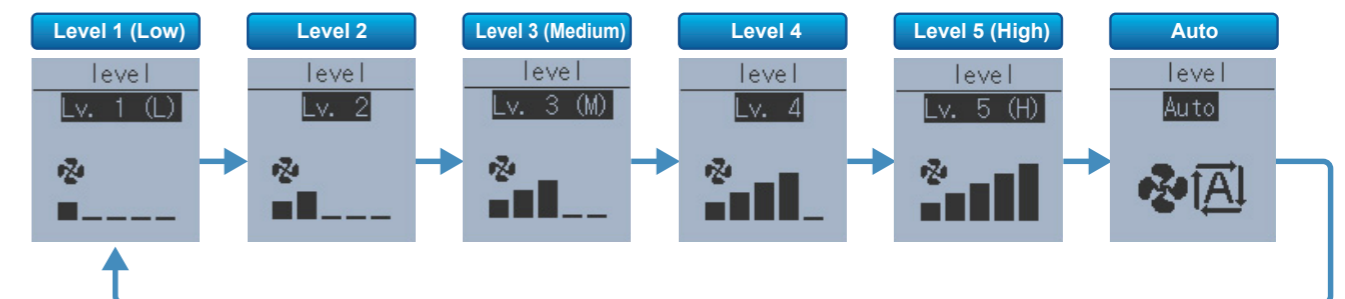

Individual Control Systems for VRF Systems

Simplified remote controller (Option)



New BRC2E61

Easy operation with new intuitive design

Simple operation

- Using only six buttons, users have direct access to basic functions. This enables them to easily set comfort to their preference.

- ON/OFF · Operation mode
- Temperature setting
- Airflow rate (5-step & Auto)*
- Up and down airflow direction (5-step & Swing)*
- ON/OFF timer

* The number of airflow steps and availability of auto airflow rate and swing mode depend on the type of indoor unit.

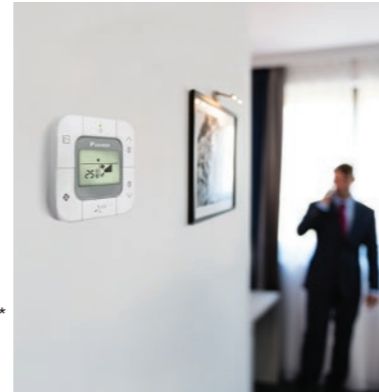

Intuitive design

- By using pictograms, the user-friendly interface enables convenient and easy operation.

Compact size

- Measuring only 85 x 85 mm, the new remote controller is extremely compact and complements any interior design.

Wireless remote controller (Option)

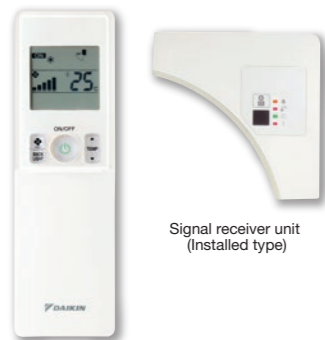

Signal receiver unit (Installed type)

New BRC-M series

- The wireless remote controller is supplied in a set with a signal receiver.
- Signal receiver unit of installed type is contained inside decoration panel or indoor unit.
- Shape of signal receiver unit differs according to the indoor unit.

Note: The signal receiver unit shown in the photograph is for mounting inside the decoration panel of FXFSQ series.

- New • Backlight LCD of new wireless remote controller



Pressing the backlight button helps operating in dark rooms.

- A compact signal receiver unit (separate type) to be mounted into a wall or ceiling is included.

* Wireless remote controller and signal receiver unit are sold as a set.
* Refer to page 194 for the name of each model.



Signal receiver unit (Separate type)

BRC-C, E series

Wide variation of remote controllers for VRF indoor units

	FXFSQ	FXFQ	FXZQ	FXUQ	FXCQ	FXEQ	FXDQ	FXDYQ	FXSQ	FXMQ	FXHQ	FXAQ	FXL(N)Q
Navigation remote controller (BRC1E63)	●	●	●	●	●		●	●	●	●	●	●	●
Simplified remote controller (BRC2E61)		●	●	●	●	●	●	●	●	●	●	●	●
Wireless remote controller* (Installed type signal receiver unit)	●	●	●	●	●	●					●	●	
Wireless remote controller* (Separate type signal receiver unit)							●	●	●	●			●

*Refer to page 194 for the name of each model.

The wired remote controller supports a wide range of control functions

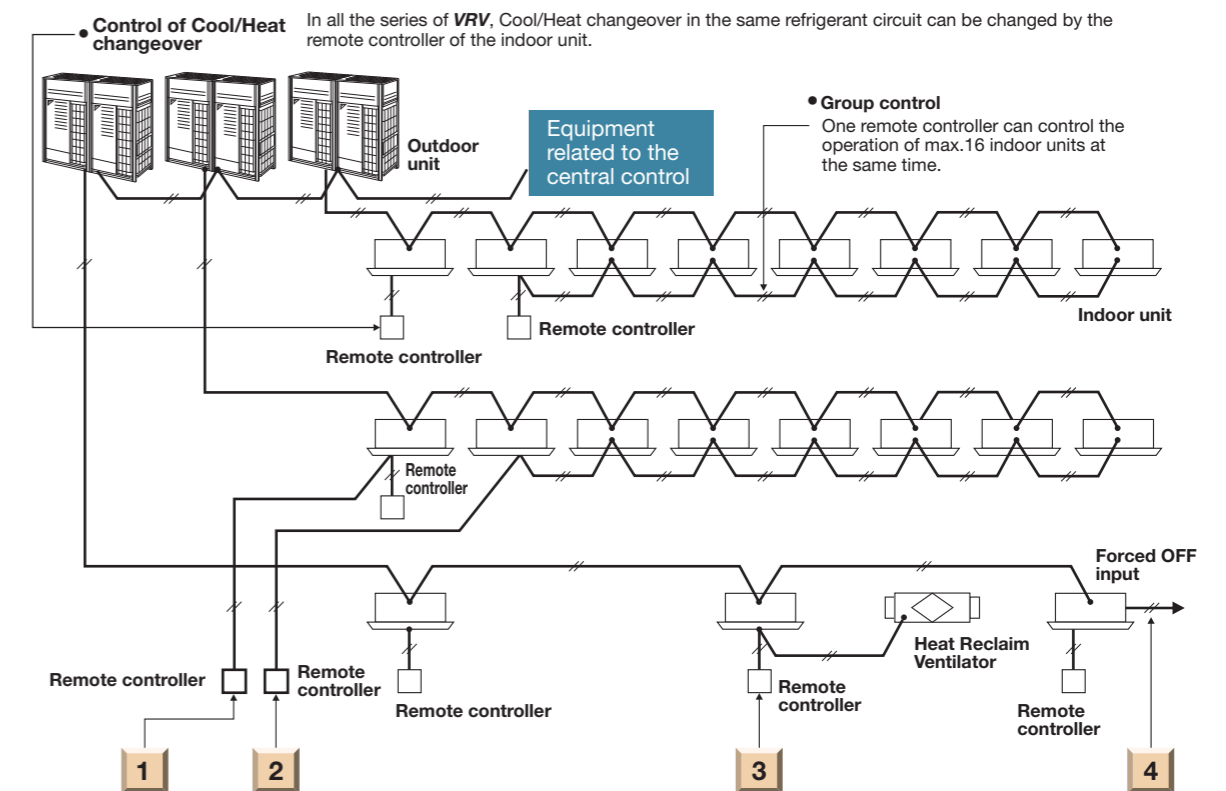

1 Control by two remote controllers

The indoor unit can be connected by the two remote controllers, for example one in the room and the other in the control room, which can control the operation of indoor unit freely. (The last command has a priority.) Of course, the group control by two remote controllers is also possible.

2 Remote control

The wiring of remote controller can be extended to max. 500 m and it is possible to install the remote controllers for different indoor units in one place.

3 Control for the combined operation

The operation of Heat Reclaim Ventilator can be controlled by the remote controller of the indoor unit. Of course, the remote controller can display the time to clean the filter.

4 Expansion of system control

The system can be expanded to add several controllers, such as BMS, Forced OFF input and etc.

Integrated Building Monitoring System

The high speed transmission of DIII-NET enables more advanced control of the **VRV** system, providing you with enhanced comfort.

- DIII-NET Line
- BACnet®/Ethernet or LONWORKS® Network Communication Line
- - - Contact Signal Line
- RS485 Modbus® Line

The DIII-NET system provides for:

- Close control and monitoring by integrating a wide variety of air-conditioners in the entire building.
- Saves the in-building cabling using non-polar, two-wire cables. Easier wiring work with tremendously fewer wiring errors.
- Additional setups readily up and running. An extendable cabling up to 2 km in total.
- Different control equipment flexibly joined in the system for hierarchical risk diversification.
- Daikin's total heat exchangers and other devices under integral control.

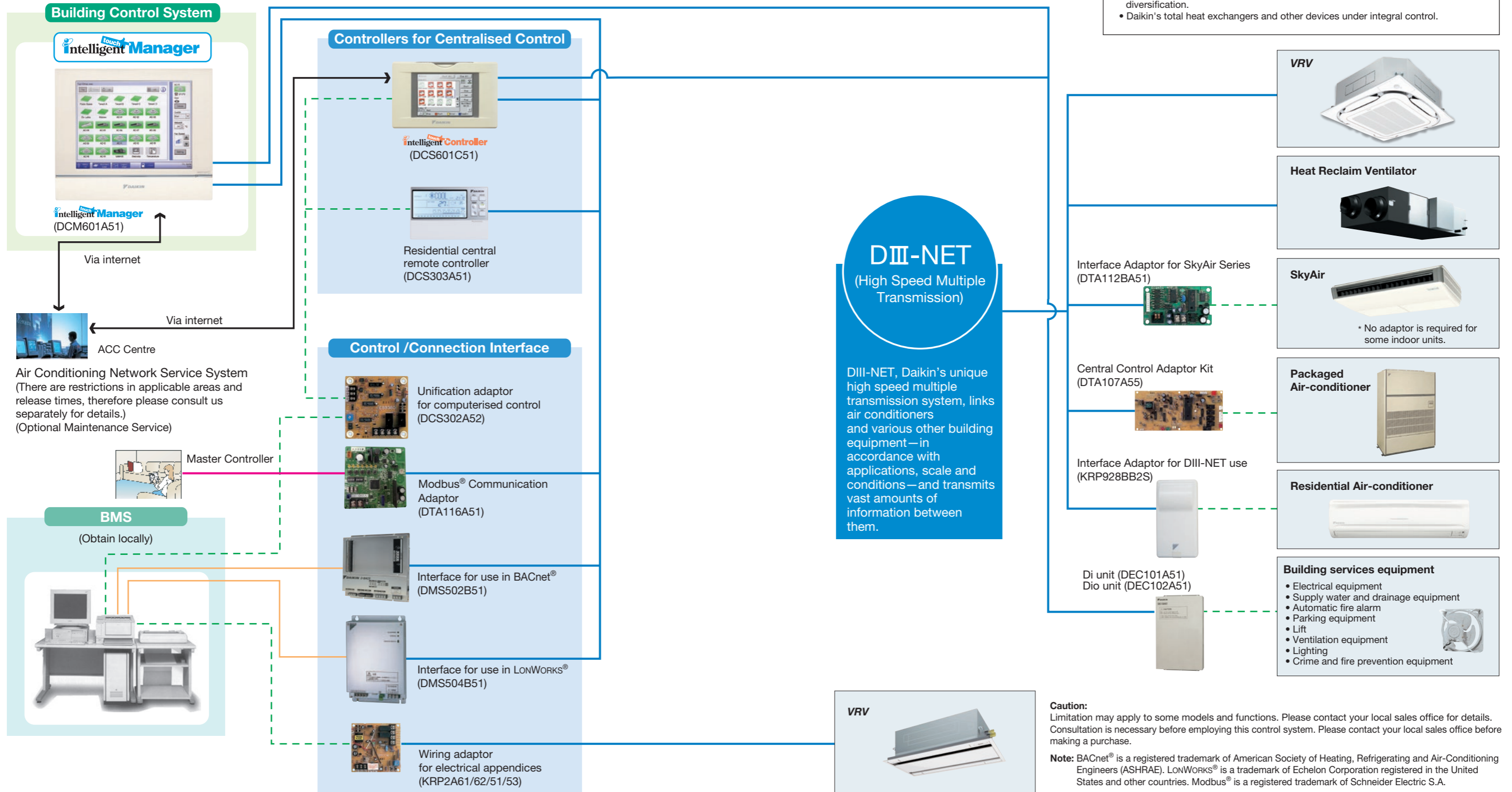

Advanced Control Systems for VRF Systems



One touch selection enables flexible control of equipment in a building.



DCM601A51

Various types of equipment in a building can be controlled by a single controller.

Individual air-conditioning control

The flexible control achieved by the VRF system precisely meets different air conditioning needs in each room (e.g. offices, conference rooms, hotel rooms).



Lighting control DALI-compatible

DALI-compatible LED lighting systems can be controlled and monitored. Lighting control is enhanced through an interlock function with air conditioners and other functions.

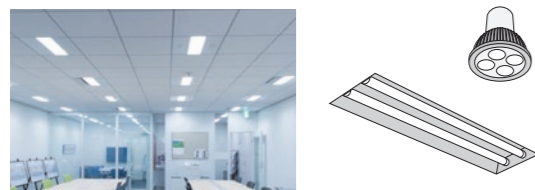

Air-conditioning control for large spaces

Air handling units can also be controlled. Large spaces, such as entrance halls and shopping malls, can be easily controlled to ensure comfort.

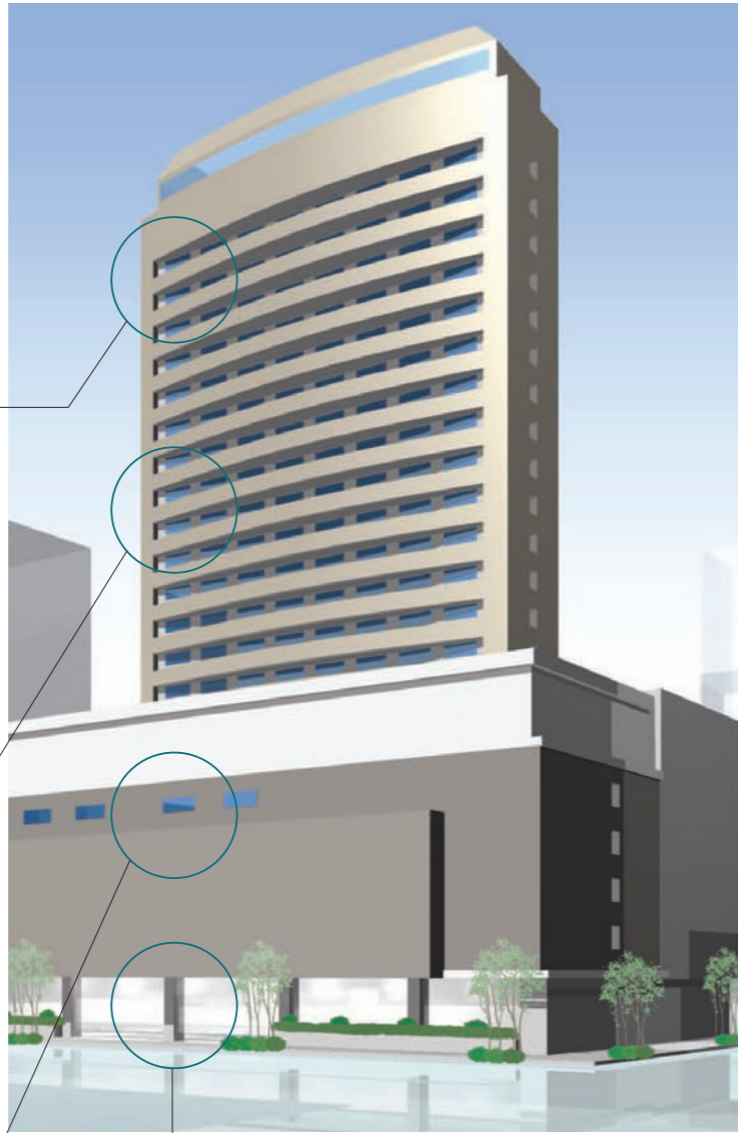

Building equipment control

Various types of equipment other than air conditioners, including ventilators, fans, and pumps, can also be controlled.

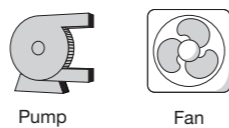

For Energy Saving & Comfort

intelligent Touch Manager maximises the advantages of VRF features

intelligent Touch Manager is an advanced multi-zone controller that provides the most cost-effective way to control and monitor the Daikin VRF system.

The 10.4" LCD touch screen is easy to use with three different screen views to include the floor plan layout view, icon view and list view and menus for system configurations.

It is also easy to use with standardized remote Web Access from your PC.

It can manage a total of 650 management points consisting of up to 512 Daikin indoor unit groups (up to 1024 indoor units) along with building equipment control / monitoring with Digital Inputs / Output (Di/Dio), Analog Inputs / Output (Ai/Ao) and Pulse input (Pi) optional devices.

Schedule the operation time for each application.	Define the setpoint range that users can change.
	<p>With Remote controller</p> <p>With Control System</p>
<p>Turn the unit OFF if a user didn't.</p>	<p>Reset setpoint regularly.</p>

Advanced Control Systems for VRV Systems

In addition to switching lights on and off, advanced lighting control, such as illuminance adjustment, can be achieved

Lighting control (Option)

Connection to DALI - compatible lighting control system

Simple wiring (daisy chain) enables management of LED lighting by the *intelligent Touch Manager*.

Various air conditioning and lighting control is enabled through the interlock with occupancy sensors and illuminance sensors.

DALI-compatible

Please contact your local sales office for details.

Lighting control achieved by the *intelligent Touch Manager*

[Operation]

- Switch-on/switch-off operation
- Illuminance (1-100%) control
- Various illuminance patterns can be registered
- Registered pattern can be selected from *intelligent Touch Manager*

[Monitoring]

- Switch-on/switch-off status monitoring
- Lighting abnormality monitoring
- Illuminance monitoring
- DALI occupancy sensor monitoring
- DALI illuminance sensor monitoring

[Overview of control]

- Up to 5 DALI modules can be connected to a single BACnet® controller.
- Up to 64 DALI LED drivers (64 addresses) can be connected to a single DALI module.
- 64 DALI addresses can be freely assigned to up to 16 groups using a single DALI module. (Each group corresponds to a management point of the *intelligent Touch Manager*.)
- Up to 16 scenes can be set to a single DALI module.
- Up to 12 sensors (occupancy, illuminance) can be connected to a single DALI module.
- DALI BAS simplifies wiring and setting work by daisy chain wiring and automatic address setting.

Air conditioning and lighting for which power consumption is high can be efficiently controlled to promote energy conservation and cost reduction!

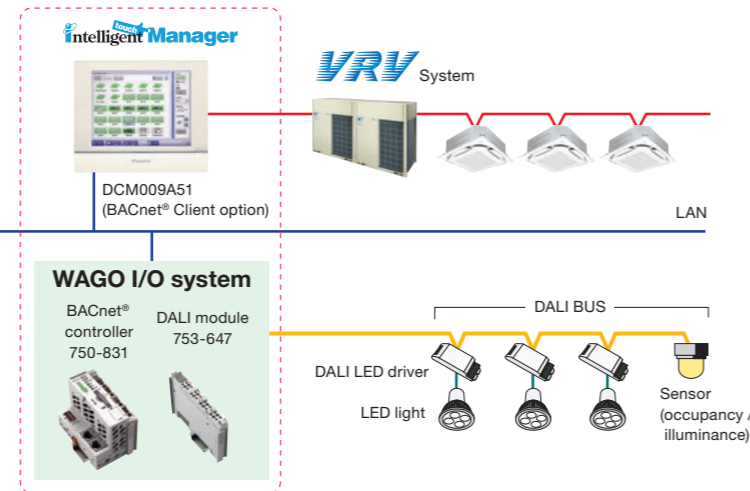

Easy maintenance and energy saving by lighting control

Case1

Switch-on / switch-off and illuminance are controlled based on a schedule to cut wasteful power consumption.

- Failing to switch off lights is prevented.



- Optimal illuminance reduces energy.

Case2

Occupancy sensors are used to eliminate both wasteful lighting and air conditioning.

When a room is unoccupied, the air conditioning stops and the lighting is switched off.

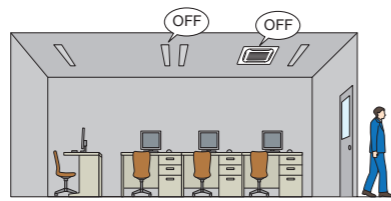

Case3

Lighting abnormalities (e.g. burned-out bulbs) can be checked on the *intelligent Touch Manager* screen.

Lighting maintenance becomes easier and quicker.

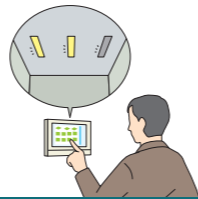

The layout screen enables quick identification of specific locations.

Tenant Management (PPD* Option)

Reporting the power consumption of VRV system for each tenant

With the PPD function, power consumption can be calculated for each indoor unit (Option)

The energy consumption is proportionally calculated for each indoor unit. The data can be used for energy management and calculation of air conditioning usage fees for respective tenants.

Operational information of individual indoor units are monitored, based on distribution of power consumption of outdoor units.

Daikin's PPD keeps track of power distribution for each indoor unit. It performs air conditioning billing calculations quickly and automatically.

It is easy to output PPD data.

PPD data is output in CSV format to a PC or USB memory device and can be freely processed and managed.

*PPD (Power Proportional Distribution) is Daikin's proprietary calculation method.

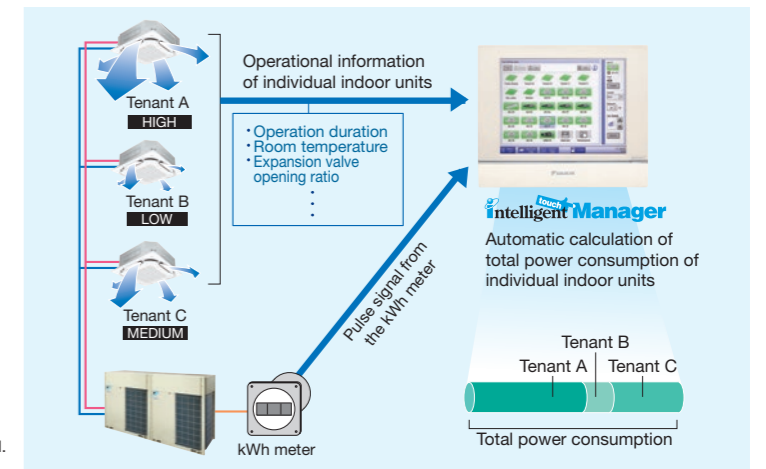

Air conditioning bills can be issued by one click

Electricity bills can be easily calculated for each tenant (Option)

The power consumption of VRV controlled by the *intelligent Touch Manager* can be easily managed for each tenant using a PC. The electricity bill settings facilitate billing work through easy calculation and issuance of VRV electricity bills.

[Main functions]

- Register tenants
- Set the electricity unit price for 5 time zones
- Calculate power consumption and electricity charge for each tenant
- Show aggregation results in the specified period for each tenant
- Output the results (Printout and CSV file)

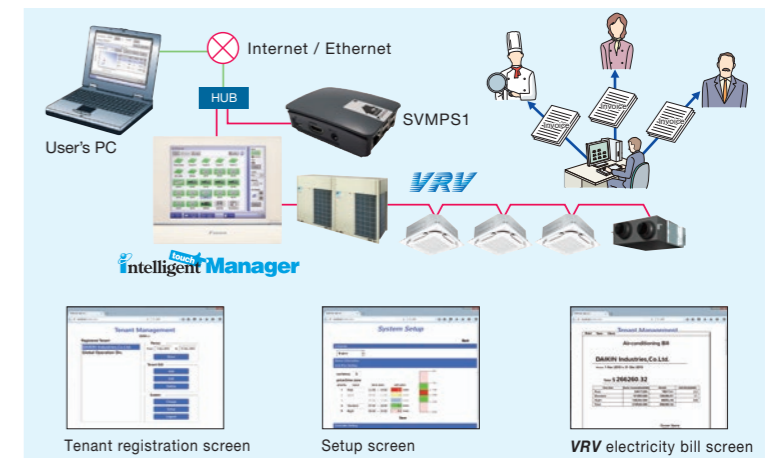

Effective service functions offered to tenants

Smartphone will be a remote controller of VRV system (Option)

Users can operate and check the status of VRV system from their smart phones via WiFi. It is not necessary to move where a remote controller is located with this feature. VRV system in other rooms can be operated, and their status can be checked. It is also possible to check if air conditioners in other rooms remain switched on etc., helping achieve energy saving.

For buildings VRV Smartphone Remote Controller

Up to 1024 indoor units can be controlled.

Just add SVMPC2 to this system

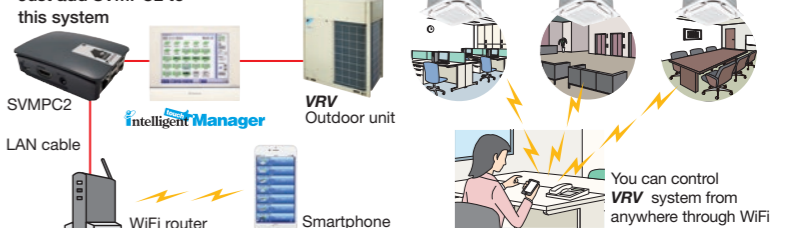

Advanced Control Systems for VRF Systems

System structure

intelligent Touch Manager System Overview

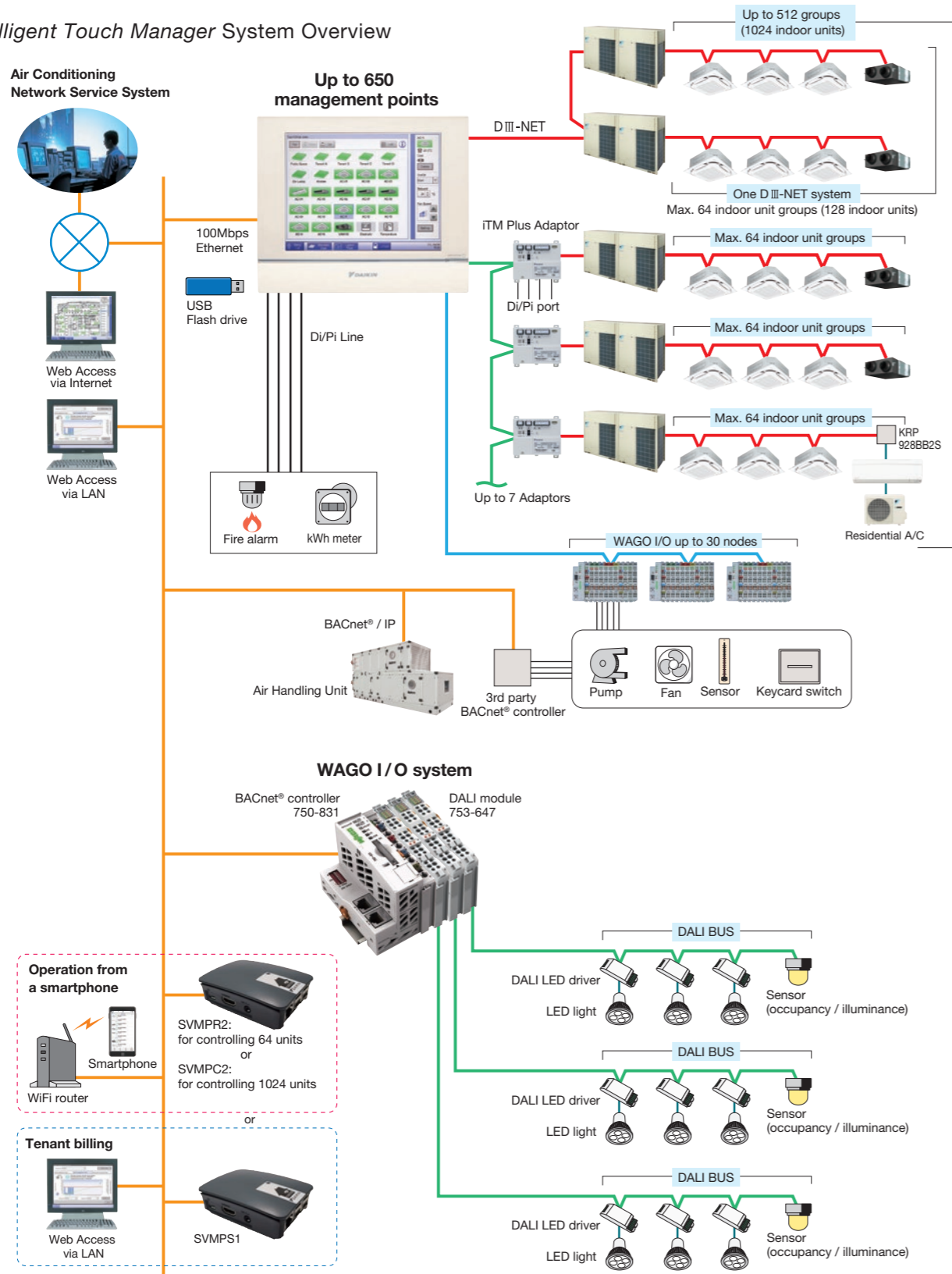

Air Conditioning Network Service System

Preventive Maintenance

The *intelligent Touch Manager* can be connected to Daikin's own Air Conditioning Network Service System for remote monitoring and verification of operation status for **VRF** system. By its ability to predict malfunctions, this service provides customers with additional peace of mind.

Enhanced convenience with link to the Air Conditioning Network Service System

The *intelligent Touch Manager* connects seamlessly to Daikin's 24-hour Air Conditioning Network Service System.

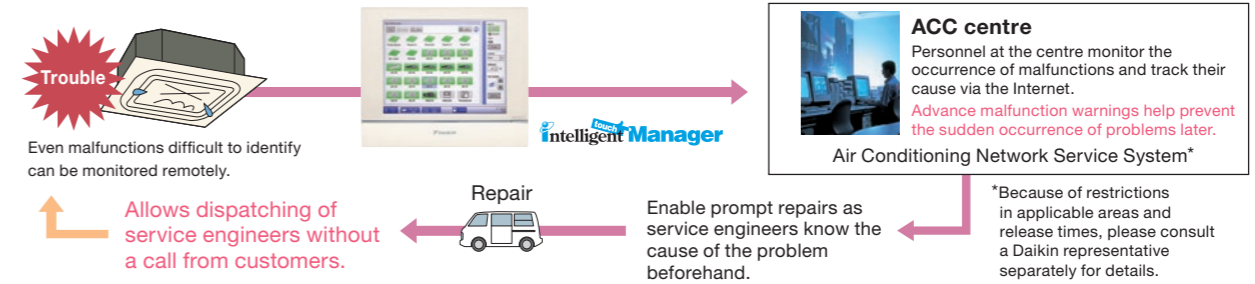

Daikin Offers a Variety of Control Systems

Convenient controllers that offer more freedom to administrators



Intelligent Controller

Ease of use and expanded control functions

The user-friendly controller features colours, multilingual function, and icons in the display for ease of understanding. A wide variety of control methods can be accommodated, permitting administrators to monitor and operate the system even when they are away from the controller.

Connect VRF system to your BMS via BACnet® or LONWORKS®

Compatible with BACnet® and LONWORKS®, the two leading open network communication protocols, Daikin offers interfaces that provide a seamless connection between **VRF** system and your BMS.



DMS502B51 (Interface for use in BACnet®)



DMS504B51 (Interface for use in LONWORKS®)

Dedicated interfaces make Daikin air conditioners freely compatible with open networks

Note: 1. BACnet® is a registered trademark of American Society of Heating, Refrigerating and Air-Conditioning Engineers (ASHRAE).
2. LONWORKS® is a trademark of Echelon Corporation registered in the United States and other countries.

Smartphone will be a remote controller of VRF system (Option)

For house VRF Smartphone Control System

Up to 64 indoor units can be controlled.

Just add SVMPS2 to this system

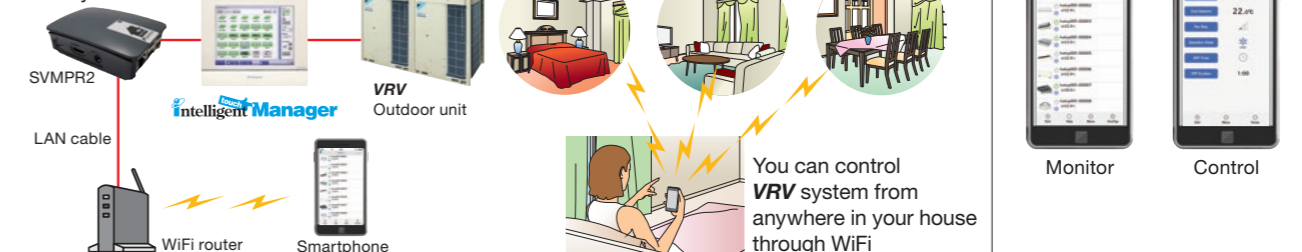

Advanced Control Systems for VRV Systems

Modbus® Communication Adaptor

Image to use Modbus® Communication Adaptor DTA116A51

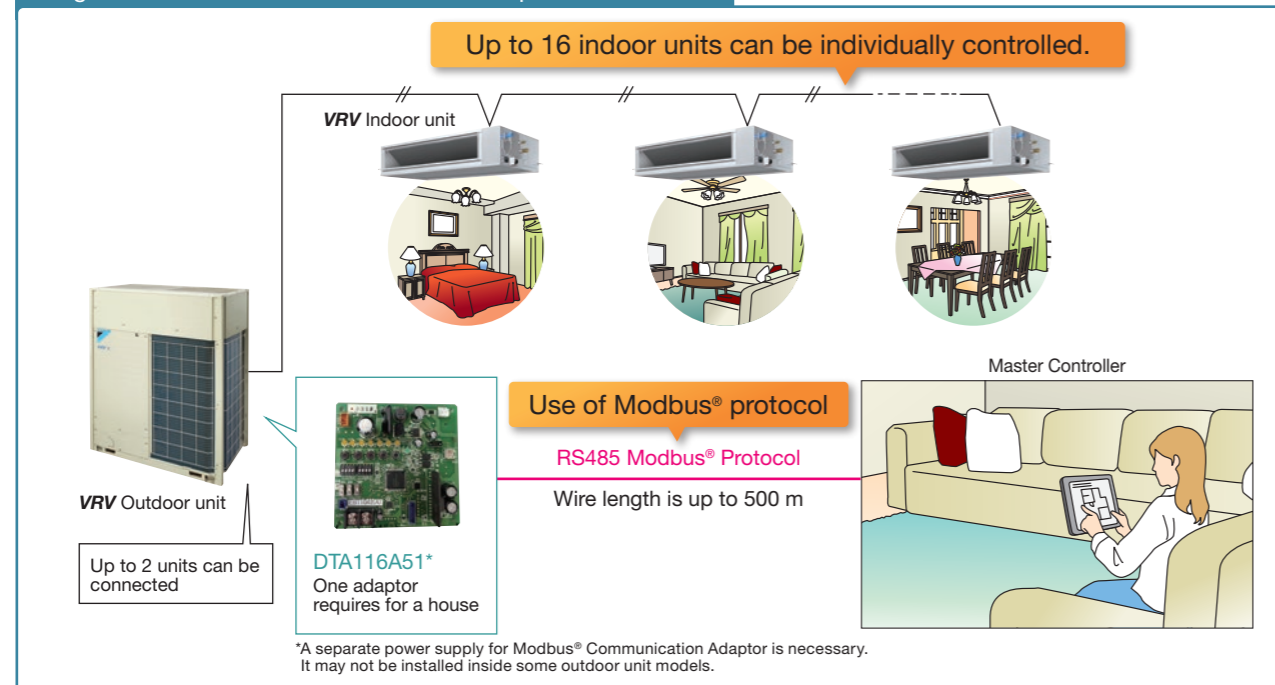

Functions

Monitor

On/Off	On/Off status of indoor units
Operation mode	Cooling, Heating, Fan, Dry, Auto (depend on indoor unit capability)
Setpoint	Setpoint of indoor units
Room temperature	Suction temperature of indoor units
Fan direction	Swing, Flap direction (depend on indoor unit capability)
Fan volume	L, M, H (depend on indoor unit capability)
Forced off status	Forced off status of indoor units
Error	Malfunction, Warning with Error code
Filter sign	Filter sign of indoor units
Communication status	Communication normal/error of indoor units

Control

On/Off	On/Off control of indoor units
Operation mode	Cooling, Heating, Fan, Dry, Auto (depend on indoor unit capability)
Setpoint	Cooling/Heating setpoint
Fan direction	Swing, Stop, Flap direction (depend on indoor unit capability)
Fan volume	L, M, H (depend on indoor unit capability)
Filter sign reset	Reset filter sign of indoor units

Retrieve system information

Connected indoor units	DIII-NET address of connected indoor units can be retrieved.
Indoor unit capabilities	Indoor unit capabilities such as operation mode, fan control, setpoint HV can be retrieved.

VRV Smartphone Control System

VRV Smartphone Control System can be realized by SVMPC1 which is a new product to utilize DTA116A51.

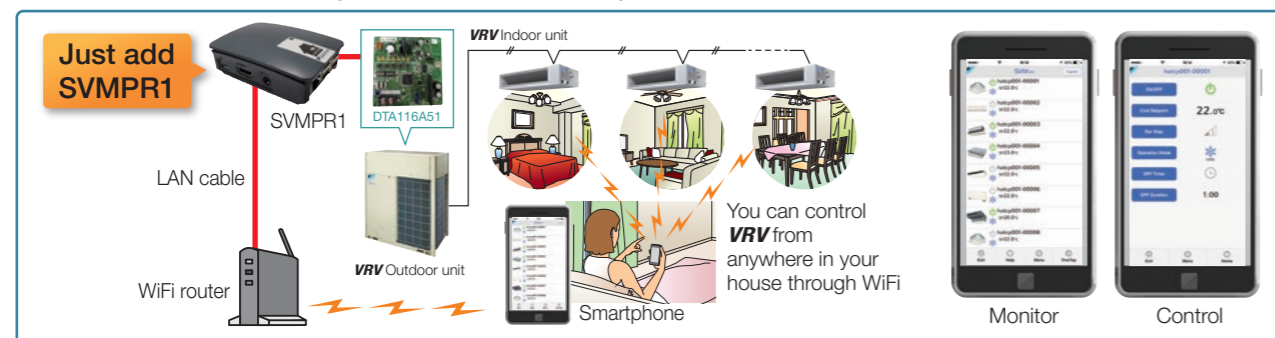

★ Modbus® is a registered trademark of Schneider Electric S.A.

VRV Tablet and Smartphone Controller : SVMPC1

The SVMPC1 is easy to install, and enables monitoring and operation of VRV systems via tablets and smartphones. It is optimal for centralized management of VRV systems in small buildings or on individual floors of a building.

Simple and easy Smart Control

- SVMPC1 is easy to install. Just add DTA116A51 to outdoor unit and connect it to controller.
- Thanks to user-friendly screen, anyone can operate easily.



- Set point range limitation and setback function achieve energy saving and comfortable air-conditioning.
- Daily air-conditioning operation is automatically done by schedule function with annual calendar.
- Quick notification of malfunction by e-mail to support quick maintenance.

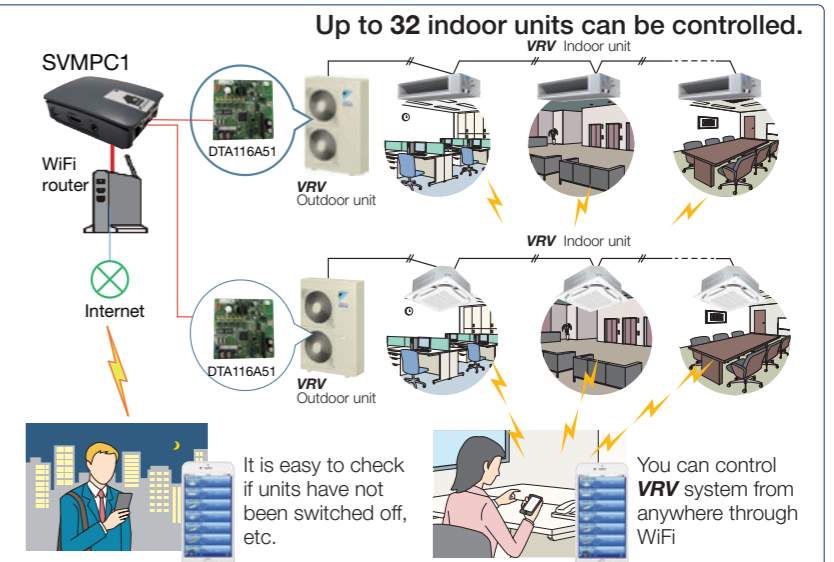

Functions

Category	Function	Detail
Main screen	Status monitoring	On/Off, Setpoint, Operation mode, Fan step, Flap, Error, Error code, Room Temperature
	Manual operation	On/Off, Setpoint, Operation mode, Fan step, Flap, Scene Control
Automatic control	Setpoint range limitation*	Cool setpoint min/max, Heat setpoint min/max
	Off timer*	Off timer on/off, Off timer duration (5min - 12h, every 5min)
	Setback operation*	Setback setpoint range (Cool: 24-35°C, Heat: 10-20°C)
	Schedule*	Action registration: Time, On/Off, Setpoint, Operation mode, Fan step, Flap, Off timer on/off, Setback setpoint Calendar setting: set by date or day of the week
	Interlock	Interlock operation depend on equipment status
System setting	Language, Password setting, User administration*, Point setting*	

*: Only admin user can set.

Specifications

Category	Specification	Detail
Connectable units	Number of indoor units	Max 16 (per DTA116A51)
	Number of DTA116A51	Max 2 (maximum of 32 indoor units can be connected)
Connectable device	Number of Tablet/Smartphone	Max 20
	Device type	iPad, iPhone, Android tablet, Android Phone, Windows Tablet, Windows Phone, Windows PC, Mac
	Web browser	Firefox, Chrome, Safari

Multi Site Management System by using SVMPC1: MSMPN1

The MSMPN1 enables monitoring and operation of all VRV system connected via SVMPC1 on each site.

Function

- Monitoring: All site information show on a MSM screen. Connection status, A/C operation status, Error status, Energy consumption etc.
- Operation: All SVMPC1 function can use on MSM screen.

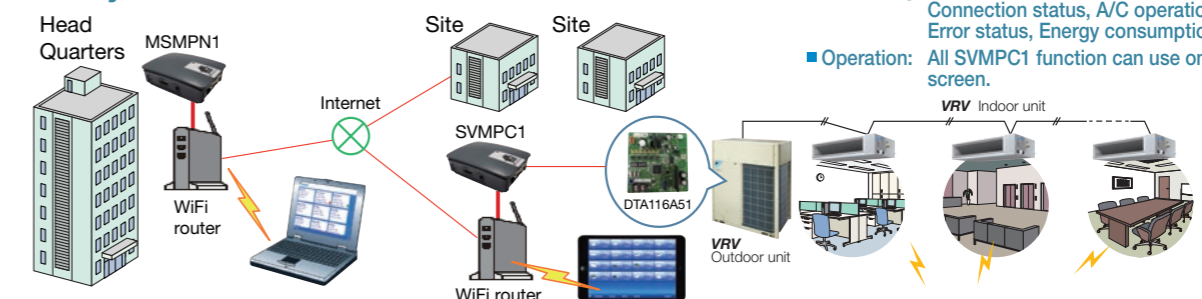

Option List

Outdoor Units

VRV H SERIES High-COP Type

No.	Item		Type	RXYQ12AH RXYQ14AH RXYQ16AH RXYQ18AH RXYQ20AH	RXYQ22AH	RXYQ24AH	RXYQ26AH RXYQ28AH RXYQ30AH RXYQ32AH RXYQ34AH RXYQ36AH
1	Distributive piping	REFNET header		KHRP26M22H, KHRP26M33H, KHRP26M72H (Max. 4 branch) (Max. 8 branch) (Max. 8 branch)			KHRP26M22H, KHRP26M33H, (Max. 4 branch) (Max. 8 branch) KHRP26M72H, KHRP26M73H (Max. 8 branch) (Max. 8 branch)
		REFNET joint		KHRP26A22T, KHRP26A33T, KHRP26A72T	KHRP26A22T, KHRP26A33T, KHRP26A72T, KHRP26A73T		
2	Pipe size reducer			KHRP26M73TP, KHRP26M73HP			
3	Outdoor unit multi connection piping kit			BHFP22P100	BHFP22P151		
4	Cool/Heat selector			KRC19-26A			

Option PCB

No.	Item		Type	RXYQ12AH RXYQ14AH RXYQ16AH	RXYQ18AH RXYQ20AH RXYQ22AH	RXYQ24AH RXYQ26AH RXYQ28AH	RXYQ30AH RXYQ32AH RXYQ34AH	RXYQ36AH
1	DIII-NET expander adaptor			DTA109A51				
2	External control adaptor			DTA104A61				
3	Modbus communication adaptor			DTA116A51				

VRV H SERIES Standard Type

No.	Item		Type	RXYQ6A RXYQ8A RXYQ10A	RXYQ12A RXYQ14A RXYQ16A	RXYQ18A RXYQ20A	RXYQ22A
1	Distributive piping	REFNET header		KHRP26M22H, KHRP26M33H (Max. 4 branch) (Max. 8 branch)	KHRP26M22H, KHRP26M33H, KHRP26M72H (Max. 4 branch) (Max. 8 branch) (Max. 8 branch)		
		REFNET joint		KHRP26A22T, KHRP26A33T	KHRP26A22T, KHRP26A33T, KHRP26A72T		
2	Outdoor unit multi connection piping kit			BHFP22P100			
3	Cool/Heat selector			KRC19-26A			

No.	Item		Type	RXYQ24A	RXYQ26A RXYQ28A RXYQ30A RXYQ32A RXYQ34A RXYQ36A	RXYQ38A RXYQ40A RXYQ42A RXYQ44A	RXYQ46A RXYQ48A RXYQ50A RXYQ52A	RXYQ54A RXYQ56A RXYQ58A RXYQ60A
1	Distributive piping	REFNET header		KHRP26M22H, KHRP26M33H, (Max. 4 branch) (Max. 8 branch) KHRP26M72H (Max. 8 branch)	KHRP26M22H, KHRP26M33H, KHRP26M72H, KHRP26M73H (Max. 4 branch) (Max. 8 branch) (Max. 8 branch) (Max. 8 branch)			
		REFNET joint		KHRP26A22T, KHRP26A33T, KHRP26A72T, KHRP26A73T				
2	Pipe size reducer			KHRP26M73TP, KHRP26M73HP				
3	Outdoor unit multi connection piping kit			BHFP22P100	BHFP22P151			
4	Cool/Heat selector			KRC19-26A				

Option PCB

No.	Item		Type	RXYQ6A RXYQ8A RXYQ10A RXYQ12A	RXYQ14A RXYQ16A RXYQ18A RXYQ20A	RXYQ22A RXYQ24A	RXYQ26A RXYQ28A RXYQ30A RXYQ32A RXYQ34A RXYQ36A	RXYQ38A RXYQ40A RXYQ42A RXYQ44A RXYQ46A RXYQ48A	RXYQ50A RXYQ52A RXYQ54A RXYQ56A RXYQ58A RXYQ60A
1	DIII-NET expander adaptor ★			DTA109A51					
2	External control adaptor ★			DTA104A61					
3	Modbus communication adaptor ★			DTA116A51					
4	Option plate for control adaptor			—	BKS26A *1	—	BKS26A *1		

Note: *1. This plate is necessary for each adaptor marked ★.

REFNET joint (KHRP26A22/33/72/73T)



VRV R SERIES High-COP Type

No.	Item		Type	REYQ12TA REYQ14TA REYQ16TA REYQ18TA REYQ20TA	REYQ22TA	REYQ24TA	REYQ26TA REYQ28TA REYQ30TA	REYQ32TA REYQ34TA REYQ36TA
1	Distributive piping	3 Pipes	REFNET header	KHRP25M33H, KHRP25M72H (Max. 8 branch) (Max. 8 branch)			KHRP25M33H, KHRP25M72H (Max. 8 branch) (Max. 8 branch) KHRP25M73H (Max. 8 branch)	
			REFNET joint	KHRP25A22T, KHRP25A33T, KHRP25A72T		KHRP25A22T, KHRP25A33T, KHRP25A72T, KHRP25A73T		
		2 Pipes	REFNET header	KHRP26M33H, KHRP26M72H (Max. 8 branch) (Max. 8 branch)			KHRP26M33H, KHRP26M72H (Max. 8 branch) (Max. 8 branch) KHRP26M73H (Max. 8 branch)	
			REFNET joint	KHRP26A22T, KHRP26A33T, KHRP26A72T				
2	Pipe size reducer			KHRP25M72TP			KHRP25M72TP, KHRP25M73TP, KHRP26M73HP	
3	Outdoor unit multi connection piping kit			BHFP26P90		BHFP26P136		

Option PCB

No.	Item		Type	REYQ12TA REYQ14TA REYQ16TA	REYQ18TA REYQ20TA REYQ22TA	REYQ24TA REYQ26TA REYQ28TA	REYQ30TA REYQ32TA REYQ34TA	REYQ36TA
1	DIII-NET expander adaptor			DTA109A51				
2	External control adaptor			DTA104A61				

VRV R SERIES Standard Type

No.	Item		Type	REYQ6TA REYQ8TA REYQ10TA	REYQ12TA REYQ14TA REYQ16TA REYQ18TA REYQ20TA	REYQ22TA	REYQ24TA	REYQ26TA REYQ28TA REYQ30TA	REYQ32TA REYQ34TA REYQ36TA
1	Distributive piping	3 Pipes	REFNET header	KHRP25M33H (Max. 8 branch)	KHRP25M33H, KHRP25M72H, (Max. 8 branch) (Max. 8 branch)			KHRP25M33H, KHRP25M72H, (Max. 8 branch) (Max. 8 branch) KHRP25M73H (Max. 8 branch)	
			REFNET joint	KHRP25A22T, KHRP25A33T	KHRP25A22T, KHRP25A33T, KHRP25A72T		KHRP25A22T, KHRP25A33T, KHRP25A72T, KHRP25A73T		
		2 Pipes	REFNET header	KHRP26M33H (Max. 8 branch)	KHRP26M33H, KHRP26M72H (Max. 8 branch) (Max. 8 branch)			KHRP26M33H, KHRP26M72H (Max. 8 branch) (Max. 8 branch) KHRP26M73H (Max. 8 branch)	
			REFNET joint	KHRP26A22T, KHRP26A33T	KHRP26A22T, KHRP26A33T, KHRP26A72T				
2	Pipe size reducer			KHRP25M72TP			KHRP25M72TP, KHRP25M73TP, KHRP26M73HP		
3	Outdoor unit multi connection piping kit			BHFP26P90					

No.	Item		Type	REYQ38TA REYQ40TA REYQ42TA	REYQ44TA REYQ46TA REYQ48TA	REYQ50TA REYQ52TA REYQ54TA	REYQ56TA REYQ58TA REYQ60TA
1	Distributive piping	3 Pipes	REFNET header	KHRP25M33H, KHRP25M72H, KHRP25M73H (Max. 8 branch) (Max. 8 branch) (Max. 8 branch)			
		REFNET joint	KHRP25A22T, KHRP25A33T, KHRP25A72T, KHRP25A73T				
2	Pipe size reducer	2 Pipes	REFNET header	KHRP26M33H, KHRP26M72H, KHRP26M73H (Max. 8 branch) (Max. 8 branch) (Max. 8 branch)			
		REFNET joint	KHRP26A22T, KHRP26A33T, KHRP26A72T				
3	Outdoor unit multi connection piping kit			KHRP25M72TP, KHRP25M73TP, KHRP26M73HP			
				BHFP26P136			

Option PCB

No.	Item		Type	REYQ6TA REYQ8TA REYQ10TA REYQ12TA	REYQ14TA REYQ16TA REYQ18TA REYQ20TA	REYQ22TA REYQ24TA	REYQ26TA REYQ28TA REYQ30TA REYQ32TA REYQ34TA REYQ36TA	REYQ38TA REYQ40TA REYQ42TA REYQ44TA REYQ46TA REYQ48TA	REYQ50TA REYQ52TA REYQ54TA REYQ56TA REYQ58TA REYQ60TA
1	DIII-NET expand adaptor ★			DTA109A51					
2	External control adaptor ★			DTA104A61					
3	Option plate for control adaptor			—	BKS26A *1	—	BKS26A *1		

Note: *1. This plate is necessary for each adaptor marked ★.

Option List

Outdoor Units

VRV IV S SERIES Heat Pump

No.	Item	Type	RXYMQ3A	RXYMQ4A	RXYMQ5A	RXYMQ6A	RXYMQ8A	RXYMQ9A
1	Cool/Heat selector		KRC19-26A					
1-1	Fixing box		KJB111A					
2	REFNET header		KHRP26M22H (Max. 4 branch) KHRP26M33H (Max. 8 branch)					
3	REFNET joint		KHRP26A22T			KHRP26A22T, KHRP26A33T		
4	Central drain plug		KKPJ5G280			KKPJ5F180		KKPJ5G280
5	Fixture for preventing overturning		KKTP5B112			KPT-60B160		KKTP5B112
6	Wire fixture for preventing overturning							K-KYZP15C

VRV IV Q SERIES Heat Pump (Standard Type)

No.	Item	Type	RQYQ6T(E) RQYQ8T(E)	RQYQ10T(E)	RQYQ12T(E)	RQYQ14T(E)	RQYQ16T(E)
1	Distributive piping	REFNET header	KHRP26M22H (Max. 4 branch), KHRP26M33H (Max. 8 branch)		KHRP26M22H, KHRP26M33H, KHRP26M72H (Max. 4 branch) (Max. 8 branch) (Max. 8 branch)		
		REFNET joint	KHRP26A22T KHRP26A33T		KHRP26A22T, KHRP26A33T, KHRP26A72T		
2	Cool / Heat selector				KRC19-26A		

No.	Item	Type	RQYQ18TN(E) RQYQ20TN(E)	RQYQ22TN(E)	RQYQ24TN(E) RQYQ26TN(E)	RQYQ28TN(E) RQYQ30TN(E) RQYQ32TN(E)
1	Distributive piping	REFNET header	KHRP26M22H, KHRP26M33H (Max. 4 branch) (Max. 8 branch), KHRP26M72H (Max. 8 branch)		KHRP26M22H, KHRP26M33H, (Max. 4 branch) (Max. 8 branch) KHRP26M72H, KHRP26M73H (Max. 8 branch)	
		REFNET joint	KHRP26A22T, KHRP26A33T, KHRP26A72T		KHRP26A22T, KHRP26A33T, KHRP26A72T, KHRP26A73T	
2	Pipe size reducer				KHRP26M73TP, KHRP26M73HP	
3	Outdoor unit multi connection piping kit				BHFP22P100	
4	Cool / Heat selector				KRC19-26A	

No.	Item	Type	RQYQ34TN(E) RQYQ36TN(E)	RQYQ38TN(E) RQYQ40TN(E)	RQYQ42TN(E) RQYQ44TN(E)	RQYQ46TN(E) RQYQ48TN(E)
1	Distributive piping	REFNET header	KHRP26M22H, KHRP26M33H, KHRP26M72H, KHRP26M73H (Max. 4 branch) (Max. 8 branch) (Max. 8 branch) (Max. 8 branch)			
		REFNET joint	KHRP26A22T, KHRP26A33T, KHRP26A72T, KHRP26A73T			
2	Pipe size reducer		KHRP26M73TP, KHRP26M73HP			
3	Outdoor unit multi connection piping kit		BHFP22P151			
4	Cool / Heat selector		KRC19-26A			

VRV IV Q SERIES Heat Pump (Space Saving Type)

No.	Item	Type	RQYQ18T(E)	RQYQ20T(E)
1	Disinbutive piping	REFNET header	KHRP26M22H, KHRP26M33H, KHRP26M72H (Max.4 branch) (Max.8 branch) (Max.8 branch)	
		REFNET joint	KHRP26A22T, KHRP26A33T, KHRP26A72T	
2	Cool / Heat selector		KRC19-26A	

No.	Item	Type	RQYQ30TS(E)	RQYQ32TS(E)	RQYQ34TS(E)	RQYQ36TS(E)	RQYQ38TS(E)	RQYQ40TS(E)
1	Disinbutive piping	REFNET header	KHRP26M22H, KHRP26M33H, KHRP26M72H, KHRP26M73H (Max.4 branch) (Max.8 branch) (Max.8 branch) (Max.8 branch)					
		REFNET joint	KHRP26A22T, KHRP26A33T, KHRP26A72T, KHRP26A73T					
2	Pipe size reducer		KHRP26M73TP, KHRP26M73HP					
3	Outdoor unit connection piping kit		BHFP22P100					
4	Cool / Heat selector		KRC19-26A					

No.	Item	Type	RQYQ42TS(E)	RQYQ44TS(E)	RQYQ46TS(E)	RQYQ48TS(E)
1	Disinbutive piping	REFNET header	KHRP26M22H, KHRP26M33H, KHRP26M72H, KHRP26M73H (Max.4 branch) (Max.8 branch) (Max.8 branch) (Max.8 branch)			
		REFNET joint	KHRP26A22T, KHRP26A33T, KHRP26A72T, KHRP26A73T			
2	Pipe size reducer		KHRP26M73TP, KHRP26M73HP			
3	Outdoor unit connection piping kit		BHFP22P151			
4	Cool / Heat selector		KRC19-26A			

VRV III-Q Heat Recovery

No.	Item	Type	RQCEQ280P RQCEQ360P	RQCEQ460P RQCEQ500P	RQCEQ540P RQCEQ636P	RQCEQ712P RQCEQ744P RQCEQ816P RQCEQ848P
1	Distributive piping	REFNET header	KHRP25M33H (Max. 8 branch) KHRP25M72H (Max. 8 branch) KHRP26M22H (Max. 4 branch) KHRP26M33H (Max. 8 branch)	KHRP25M33H (Max. 8 branch) KHRP25M72H (Max. 8 branch) KHRP25M73H (Max. 8 branch) KHRP26M22H (Max. 4 branch) KHRP26M33H (Max. 8 branch)	KHRP25M33H (Max. 8 branch) KHRP25M72H (Max. 8 branch) KHRP25M73H (Max. 8 branch) KHRP26M22H (Max. 4 branch) KHRP26M33H (Max. 8 branch)	KHRP25M33H (Max. 8 branch) KHRP25M72H (Max. 8 branch) KHRP25M73H (Max. 8 branch) KHRP26M22H (Max. 4 branch) KHRP26M33H (Max. 8 branch) KHRP26M72H (Max. 8 branch)
		REFNET joint	KHRP25A22T (Max. 4 branch) KHRP25A33T (Max. 8 branch) KHRP25A72T (Max. 8 branch) KHRP26A22T (Max. 4 branch) KHRP26A33T (Max. 8 branch)	KHRP25A22T (Max. 4 branch) KHRP25A33T (Max. 8 branch) KHRP25A72T (Max. 8 branch) KHRP25A73T (Max. 8 branch) KHRP26A22T (Max. 4 branch) KHRP26A33T (Max. 8 branch)	KHRP25A22T (Max. 4 branch) KHRP25A33T (Max. 8 branch) KHRP25A72T (Max. 8 branch) KHRP25A73T (Max. 8 branch) KHRP26A22T (Max. 4 branch) KHRP26A33T (Max. 8 branch)	KHRP25A22T (Max. 4 branch) KHRP25A33T (Max. 8 branch) KHRP25A72T (Max. 8 branch) KHRP25A73T (Max. 8 branch) KHRP26A22T (Max. 4 branch) KHRP26A33T (Max. 8 branch) KHRP26A72T (Max. 8 branch)
2	Outdoor unit multi connection piping kit		BHFP26P36C		BHFP26P63C	BHFP26P84C
3	Digital pressure gauge kit		BHGP26A1x2		BHGP26A1x3	BHGP26A1x4

VRV IV W SERIES Heat Pump / Heat Recovery

No.	Item	Type	RWEYQ6T RWEYQ8T RWEYQ10T RWEYQ12T	RWEYQ14T RWEYQ16T RWEYQ18T RWEYQ20T RWEYQ22T RWEYQ24T	RWEYQ26T RWEYQ28T RWEYQ30T RWEYQ32T RWEYQ34T RWEYQ36T
1	Cool/heat selector		KRC19-26A (Applies to heat pump type only)		
1-1	Fixing box		KJB111A (Applies to heat pump type only)		
2	Distributive piping	REFNET header	KHRP25M33H (Max. 8 branch), KHRP26M22H (Max. 4 branch), KHRP26M33H (Max. 8 branch)	KHRP25M33H (Max. 8 branch), KHRP25M72H (Max. 8 branch), KHRP26M22H (Max. 4 branch), KHRP26M33H (Max. 8 branch), KHRP26M72H (Max. 8 branch)	KHRP25M33H (Max. 8 branch), KHRP25M72H (Max. 8 branch), KHRP25M73H (Max. 8 branch), KHRP26M22H (Max. 4 branch), KHRP26M33H (Max. 8 branch), KHRP26M72H (Max. 8 branch), KHRP26M73H (Max. 8 branch)
		REFNET joint	KHRP25A22T, KHRP25A33T, KHRP26A22T, KHRP26A33T	KHRP25A22T, KHRP25A33T, KHRP25A72T, KHRP26A22T, KHRP26A33T, KHRP26A72T	KHRP25A22T, KHRP25A33T, KHRP25A72T, KHRP26A22T, KHRP26A33T, KHRP26A72T
3	Outside unit multi connection piping kit	For heat pump	—	BHFP22MA56	BHFP22MA84
		For heat recovery	—	BHFP26MA56	BHFP26MA84
4	External control adaptor		DTA104A62		
5	Strainer kit		BWU26A15, BWU26A20		

Note: ★ 1 In the case of heat recovery system, cool/heat selector cannot be connected.

VRV IV W SERIES Strainer kit specifications

Model	BWU26A15	BWU26A20
Pressure resistance	MPa	1.47
Mesh size		50
Connection diameter	PT1 1/4B internal thread	PT1 1/4B internal thread

VRV WS SERIES

No.	Item	Type	RWQ3A	RWQ4A	RWQ5A	RWQ6A
1	Distributive piping	REFNET header	KHRP26M22H, KHRP26M33H (Max. 4 branch) (Max. 8 branch)			
		REFNET joint	KHRP26A22T			

VRV Indoor Units



Ceiling Mounted Cassette (Round Flow with Sensing) Type

No.	Item		Type	Type		
				FXFSQ25A FXFSQ32A FXFSQ40A	FXFSQ50A FXFSQ63A FXFSQ80A	FXFSQ100A FXFSQ125A FXFSQ140A
1	Decoration panel	Standard panel with sensing	Fresh white	BYCQ125EEF		
			Black	BYCQ125EEK		
2	Sealing material of air discharge outlet ¹		For usage of 3-, 4-way flow	KDBH551C160		
			For usage of 2-way flow	KDBH552C160		
3	Panel spacer		KDB55J160F			
4	Fresh air intake kit	Chamber type ^{2,3}	Without T-duct joint	KDDP55B160 (Components: KDDP55C160-1, KDDP55B160-2) ⁵		
			With T-duct joint	KDDP55B160K (Components: KDDP55C160-1, KDDP55B160K2) ⁵		
			Direct installation type ⁴	KDDP55X160A		
5	High-efficiency filter unit ⁶ (Including filter chamber)		(Colorimetric method 65%)	KAF556D80	KAF556D160	
			(Colorimetric method 90%)	KAF557D80	KAF557D160	
6	Replacement high-efficiency filter ^{6,7}		(Colorimetric method 65%)	KAF552D80	KAF552D160	
			(Colorimetric method 90%)	KAF553D80	KAF553D160	
7	Filter chamber		KDDFP55C160			
8	Replacement long-life filter		KAF551D160			
9	Ultra long-life filter unit (Including filter chamber) ⁶		KAF555D160			
10	Replacement ultra long-life filter ^{6,7}		KAF550D160			
11	Branch duct chamber ¹		KDJP55C80	KDJP55C160		
12	Insulation kit for high humidity ^{6,8}		KDTP55K80A	KDTP55K160A		

Note: 1. Circulation airflow is not available with this option.

2. When installing a fresh air intake kit (chamber type), two air outlet corners are closed.
3. It is recommended that the volume of outdoor air introduced through the kit is limited to 10% of the maximum airflow rate of the indoor unit. Introducing higher quantities will increase the operating sound and may also influence temperature sensing.
4. The volume of fresh air for direct installation type is approximately 1% of the indoor unit airflow. The chamber type is recommended when more fresh air is necessary.

5. Please order using the names of both components instead of set name.

6. This option cannot be installed to designer panel and auto grille panel.

7. Filter chamber is required.

8. Please use in case temperature/humidity inside ceiling may get over 30°C, 80% RH.

Ceiling Mounted Cassette (Round Flow) Type



No.	Item		Type	Type							
				FXFQ25P	FXFQ32P	FXFQ40P	FXFQ50P	FXFQ63P	FXFQ80P	FXFQ100P	FXFQ125P
1	Decoration panel			BYCP125K-W1							
2	Sealing material of air discharge outlet			KDBH55K160F							
3	Panel spacer			KDB55J160F							
4	Filter related	High efficiency filter unit 65%		KAF556D80				KAF556D160			
		High efficiency filter unit 90%		KAF557D80				KAF557D160			
		Replacement high efficiency filter 65%		KAF552D80				KAF552D160			
		Replacement high efficiency filter 90%		KAF553D80				KAF553D160			
		Filter chamber		KDDFP55C160							
		Long life replacement filter		KAF551D160							
		Ultra long-life filter unit		KAF555D160							
5	Fresh air intake kit	Chamber type	Without T-duct joint	KDDP55B160 (Components: KDDP55C160-1, KDDP55B160-2) ^{*1}							
			With T-duct joint	KDDP55B160K (Components: KDDP55C160-1, KDDP55B160K2) ^{*1}							
6	Branch duct chamber			KDJP55B80				KDJP55B160			
7	Chamber connection kit			KKSJ55K160							
8	Insulation kit for high humidity			KDTP55K80A				KDTP55K160A			

Note: *1. Please order using the names of both components instead of set name.

Options of Ceiling Mounted Cassette (Round Flow with Sensing) Type

Options required for specific operating environments

Ultra long-life filter unit

Even in dusty environments where the air conditioning is constantly operating, the ultra long-life filter only has to be cleaned once a year.

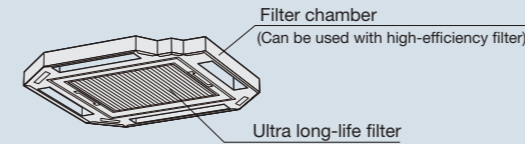

Dusty area: annual filter change

*For dust concentration of 0.3 mg/m³ (Requires separately sold Air purifier)
1 year (Approx. 5,000 hr) ≈ 15 hr/day x 28 day/month x 12 month/year

Ordinary store or office: filter change every 4 years

*For dust concentration of 0.15 mg/m³
4 years (Approx. 10,000 hr) ≈ 8 hr/day x 25 day/month x 12 month/year x 4 years

High-efficiency filter unit

Available in two types: 65% and 90% colorimetry.

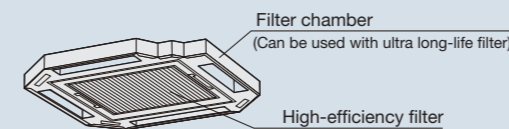

Insulation kit for high humidity

Please use if you think the temperature and humidity inside the ceiling exceeds 30°C and RH 80%, respectively.

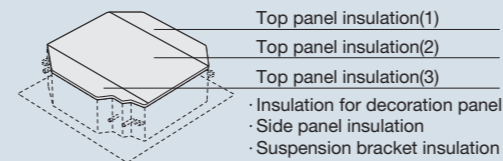

Panel spacer

Use when only minimal space is available between drop ceilings and ceiling slabs.

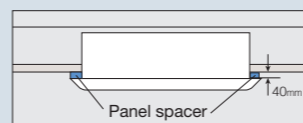

Note: Some ceiling constructions may hinder installation. Contact your Daikin Dealer before installing your unit.

Sealing material of air discharge outlet

Sealing material block air discharge openings not used in 2-way or 3-way blow.

Branch duct chamber

This chamber lets you connect a round flexible duct to the air discharge opening at any time after the original installation.

Fresh air intake kit^{Note 1, 2}

Using this kit, a duct can be connected to take in outdoor air. There are two chamber types that have intake in two places: with T-duct joint and without T-duct joint.

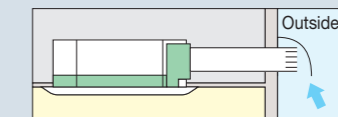

The units can be installed in the following different ways

Chamber type (without T-duct joint)^{Note 3, 4, 5}

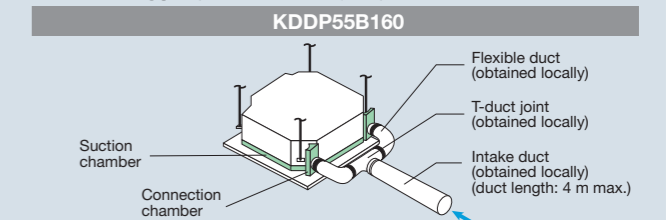

Chamber type (with T-duct joint)^{Note 3, 4, 5}

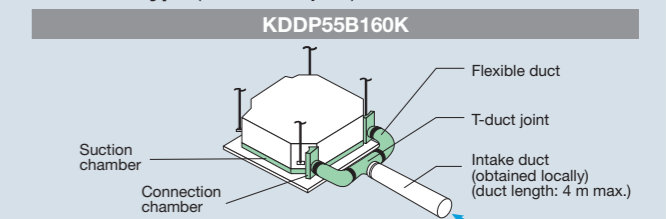

Direct installation type^{Note 6}

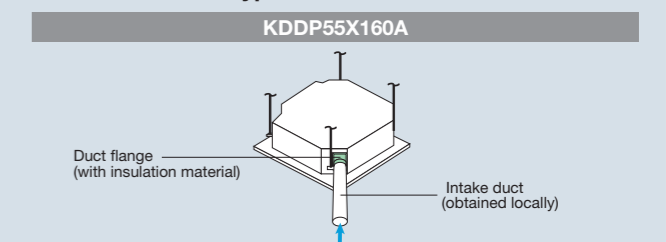

- Note: 1. Use of options will increase operating sound.
2. Connecting ducts, fan, insect nets, fire dampers, air filters, and other parts should, as required, be obtained locally.
3. When a local-obtained fan is used, an interlock with air conditioner is necessary. Optional PCB (KRP1C11A) is required for interlocking.
4. When installing a fresh air intake kit (chamber type), two air outlet corners are closed.
5. It is recommended that the volume of outdoor air introduced through the kit is limited to 10% of the maximum airflow rate of the indoor unit. Introducing higher quantities will increase the operating sound and may also influence temperature sensing.
6. The volume of fresh air for direct installation type is approximately 1% of the indoor unit airflow. The chamber type is recommended when more fresh air is necessary.

VRV Indoor Units

Ceiling Mounted Cassette (Compact Multi Flow) Type

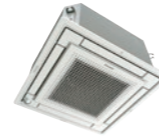

No.	Item	Type	FXZQ20A2	FXZQ25A2	FXZQ32A2	FXZQ40A2	FXZQ50A2
1	Decoration panel				BYFQ60C2W1W		
2	Sealing material of air discharge outlet				BDBHQ44C60		
3	Sensor kit				BRYPQ60A2W		
4	Replacement long-life filter				KAF441C60		
5	Fresh air intake kit	Direct installation type			KDDQ44XA60		

4-Way Flow Ceiling Suspended Type



No.	Item	Type	FXUQ71A	FXUQ100A
1	Sealing material of air discharge outlet			KDBHP49B140
2	Decoration panel for air discharge			KDBTP49B140
3	Replacement long-life filter			KAFP551K160

Ceiling Mounted Cassette (Double Flow) Type



No.	Item	Model	FXCQ20A	FXCQ25A	FXCQ32A	FXCQ40A	FXCQ50A	FXCQ63A	FXCQ80A	FXCQ125A
1	Decoration panel		BYBCQ40CF				BYBCQ63CF		BYBCQ125CF	
2	High efficiency filter *1	65 %	KAF532C50				KAF532C80		KAF532C160	
		90 %	KAF533C50				KAF533C80		KAF533C160	
3	Filter chamber for bottom suction		KDDFP53B50				KDDFP53B80		KDDFP53B160	
4	Long life replacement filter		KAF531C50				KAF531C80		KAF531C160	

Note:*1. If installing high efficiency filter, filter chamber is required.

Ceiling Mounted Cassette (Single Flow) Type



No.	Item	Type	FXEQ20A FXEQ25A	FXEQ32A FXEQ40A	FXEQ50A FXEQ63A
1	Decoration panel		BYEP40AW1		BYEP63AW1

Slim Ceiling Mounted Duct Type (Compact Series)



No.	Item	Type	FXDQ20T	FXDQ25T	FXDQ32T	FXDQ40T	FXDQ50T	FXDQ63T
1	3-D Auto Swing Discharge Grille		BDG20A09			BDG20A15		BDG20A20
2	Auto Clean Air Filter Module		BAE20A62			BAE20A82		BAE20A102

Slim Ceiling Mounted Duct Type (Standard Series)

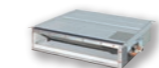

No.	Item	Type	FXDQ20PD	FXDQ25PD	FXDQ32PD	FXDQ40ND	FXDQ50ND	FXDQ63ND
1	Insulation kit for high humidity			KDT25N32			KDT25N50	KDT25N63

Ceiling Concealed (Duct) Type



No.	Item	Type	FXDYQ80MA	FXDYQ100MA	FXDYQ125MA	FXDYQ145MA
1	Run/fault status PCB				KRP1B5X	

Middle Static Pressure Ceiling Mounted Duct Type



No.	Item	Type	FXSQ20PA FXSQ25PA FXSQ32PA	FXSQ40PA	FXSQ50PA FXSQ63PA FXSQ80PA	FXSQ100PA FXSQ125PA	FXSQ140PA
1	High efficiency filter *1	65%	KAF632C36	KAF632C56	KAF632C80	KAF632C160	KAF632B160B
		90%	KAF633C36	KAF633C56	KAF633C80	KAF633C160	KAF633B160B
2	Filter chamber (for rear suction) *1		KDDFP63B36	KDDFP63B56	KDDFP63B80	KDDFP63B160	KDDFP63B160B
3	Long-life filter *1		KAF631C36	KAF631C56	KAF631C80	KAF631C160	KAF631B160B
4	Service panel	White	KTBJ25K36W	KTBJ25K56W	KTBJ25K80W		KTBJ25K160W
		Fresh white	KTBJ25K36F	KTBJ25K56F	KTBJ25K80F		KTBJ25K160F
		Brown	KTBJ25K36T	KTBJ25K56T	KTBJ25K80T		KTBJ25K160T
5	Air discharge adaptor		KDAP25A36A	KDAP25A56A	KDAP25A71A	KDAP25A140A	KDAP25A160A *2
6	Shield plate for side plate				KDBD63A160		-

Note:*1. If installing high efficiency filter and long-life filter to the unit, filter chamber is required.

*2. This option is a set of KDAP25A140A and KDBHP37A160.

Ceiling Mounted Duct Type



No.	Item	Type	FXMQ20PA FXMQ25PA FXMQ32PA	FXMQ40PA	FXMQ50PA FXMQ63PA FXMQ80PA	FXMQ100PA FXMQ125PA FXMQ140PA	FXMQ160P FXMQ180P FXMQ200P FXMQ250P
1	Drain pump kit						BDU37A250
2	High efficiency filter	65%	KAF372AA36	KAF372B56	KAF372B80	KAF372B160	
		90%	-	KAF373B56	KAF373B80	KAF373B160	
3	Filter chamber		-	KDDF37AA56	KDDF37AA80	KDDF37AA160	
4	Long life replacement filter		-	KAF371B56	KAF371B80	KAF371B160	
5	Long life filter chamber kit		-	KAF375B56	KAF375B80	KAF375B160	
6	Service panel	White	KTBJ25K36W	KTBJ25K56W	KTBJ25K80W	KTBJ25K160W	
		Fresh white	KTBJ25K36F	KTBJ25K56F	KTBJ25K80F	KTBJ25K160F	
		Brown	KTBJ25K36T	KTBJ25K56T	KTBJ25K80T	KTBJ25K160T	
7	Air discharge adaptor		KDAJ25K36A	KDAJ25K56A	KDAJ25K71A	KDAJ25K140A	

Ceiling Suspended Type



No.	Item	Type	FXHQ32MA	FXHQ63MA	FXHQ100MA	FXHQ125A	FXHQ140A
1	Drain pump kit		KDU50N60VE		KDU50N125VE		KDU50R160
2	Replacement long-life filter		KAFJ501D56	KAFJ501D80	KAFJ501D112		KAF501B160
3	L-type piping kit (for upward direction)		KHFP5M63		KHFP5M160		KHFP5N160

Wall Mounted Type



No.	Item	Type	FXAQ20A	FXAQ25A	FXAQ32A	FXAQ40A	FXAQ50A	FXAQ63A
1	Drain pump kit						K-KDU572EVE	
2	External EV kit (for heating operation) *1				BEV15D			BEV30D

Note:*1. This option is only effective for reducing operation sound during heating operation. Therefore it is ineffective when connected to cooling only outdoor units.

Floor Standing Type



No.	Item	Type	FXLQ20MA	FXLQ25MA	FXLQ32MA	FXLQ40MA	FXLQ50MA	FXLQ63MA
1	Long life replacement filter		KAF361L28		KAF361L45			KAF361L71

Concealed Floor Standing Type



No.	Item	Type	FXNQ20MA	FXNQ25MA	FXNQ32MA	FXNQ40MA	FXNQ50MA	FXNQ63MA
1	Long life replacement filter		KAF361L28		KAF361L45			KAF361L71

Residential Indoor Units with Connection to BP Units

Ceiling Mounted Cassette (Compact Multi Flow) Type



No.	Item	Type	FFQ25B	FFQ35B	FFQ50B	FFQ60B
1	Decoration panel			BYFQ60B3W1		
2	Replacement long-life filter			KAF441C60		
3	Fresh air intake kit	Direct installation type		KDDQ44XA60		
4	Sealing material for air discharge outlet			KDBH44BA60		
5	Panel spacer			KDBQ44BA60A		

Slim Ceiling Mounted Duct Type

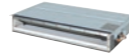

No.	Item	Type	FDXS25C	FDXS35C	FDXS50C	FDXS60C
1	Insulation kit for high humidity			KDT25N50		KDT25N63

Wall Mounted Type



No.	Item	Type	FTXS20K	FTXS25K	FTXS35K	FTXS50KA	FTXS60KA	FTXS71KA
1	Titanium apatite deodorising filter				KAF970A46			

Note: Filter is a standard accessory. It should be replaced approximately 3 years.

BP Units for Connection to Residential Indoor Units



No.	Item	Type	BPMKS967A3	BPMKS967A2
1	REFNET joint			KHRP26A22T

Note: A single BP unit does not require a REFNET joint. 2 BP units require only 1 REFNET joint, and 3 BP units require only 2 REFNET joints.

BS Units for Heat Recovery

Individual BS Unit



No.	Item	Type	BSQ100A	BSQ160A	BSQ250A
1	Quiet kit			KDDN26A1	
2	External control adaptor for outdoor units			DTA104A61	
3	Adaptor for multi tenant			DTA114A61	

Centralised BS Unit



No.	Item	Type	BS4Q14A	BS6Q14A	BS8Q14A	BS10Q14A	BS12Q14A	BS16Q14A
1	Closed pipe kit					KHFP26A100C		
2	Joint kit					KHRP26A250T		
3	Quiet kit		KDDN26B4	KDDN26B8		KDDN26B12		KDDN26B16

Control Systems

Operation Control System Optional Accessories



For VRV indoor unit use

No.	Item	Type	FXFSQ-A	FXFQ-P	FXZQ-A2	FXUQ-A	FXCQ-A	FXEQ-A	FXDQ-T	FXDQ-PD FXDQ-ND
1	"Nav Ease" remote controller		BRC1E63 Note 5	BRC1E63	BRC1E63 Note 5	BRC1E63	BRC1F61		BRC1E63	
2	Simplified remote controller					BRC2E61				
3	Wireless remote controller		BRC7M634F (Fresh White) / BRC7M634K (Black)	BRC7M634F	BRC7E530W	BRC7CB58	BRC7M65	BRC4M61		BRC4C65
4-1	Adaptor for wiring (operation status output)		★BRP11B62							★BRP11B61
4-2	Adaptor for wiring		★KRP1C11A	★KRP1C63	★KRP1BA57		★KRP1B61		★KRP1C64	★KRP1B56
5-1	Wiring adaptor for electrical appendices (1)			★KRP2A62	★KRP2A526		★KRP2A61		★KRP2A61	★KRP2A53
5-2	Wiring adaptor for electrical appendices (2)				★KRP4AA53		★KRP4AA51		★KRP4AA51	★KRP4A54
6	Remote sensor (for indoor temperature)		KRCS01-5B		BRC501A-4		BRC501A-1		BRC501A-4	BRC501A-1
7	Installation box for adaptor PCB☆		Note 2, 3 KRP1H98A	Note 4 KRP1BA101	KRP1BA97	Note 2, 3 KRP1B96			BRP9A90	Note 4 KRP1BA101
8	External control adaptor for outdoor unit			★DTA104A62			★DTA104A61		★DTA104A61	★DTA104A53
9	Adaptor for multi tenant			★DTA114A61						
10	Multi tenancy kit							Note 2 KRP114A3		

No.	Item	Type	FXDYQ-MA	FXSQ-PA	FXMQ-PA	FXMQ-P	FXHQ-MA	FXHQ-A	FXAQ-A	FXLQ-MA FXNQ-MA
1	"Nav Ease" remote controller									BRC1E63
2	Simplified remote controller									BRC2E61
3	Wireless remote controller		BRC4C62		BRC4C65		BRC7EA63W	BRC7M53	BRC7M675	BRC4C62
4-1	Adaptor for wiring (operation status output)			★BRP11B62			★BRP11B61			BRP11B62
4-2	Adaptor for wiring		KRP1B61	★KRP1C64	★KRP1C67		KRP1BA54			KRP1B61
5-1	Wiring adaptor for electrical appendices (1)		KRP2A61	★KRP2A61		★KRP2A62			★KRP2A61	KRP2A61
5-2	Wiring adaptor for electrical appendices (2)		KRP4AA51	★KRP4AA51		★KRP4AA52			★KRP4AA51	KRP4AA51
6	Remote sensor (for indoor temperature)		BRC501A-1		BRC501A-4	BRC501-6B	BRC501A-1	BRC501A-4		BRC501A-1
7	Installation box for adaptor PCB☆			Note 2, 3 KRP4A98	Note 2, 3 KRP4A97	BRP9A90	Note 3 KRP1CA93	Note 3 KRP1D93A	Note 2, 3 KRP4AA93	
8	External control adaptor for outdoor unit		DTA104A61	★DTA104A61			★DTA104A62		★DTA104A61	DTA104A61
9	Adaptor for multi tenant				★DTA114A61				★DTA114A61	

- Note: 1. Installation box☆ is necessary for each adaptor marked★.
 2. Up to 2 adaptors can be fixed for each installation box.
 3. Only one installation box can be installed for each indoor unit.
 4. Up to 2 installation boxes can be installed for each indoor unit.
 5. Some functions can be set only via the wired remote controller BRC1E63. They cannot be set via other remote controllers. Please refer to each indoor unit and remote controller page for function details.
 6. Since the control panel is equipped as standard, use the option of BRC1E63 for 2 remote control system.
 7. When using BRC1E63 or BRC2E61, be sure to remove the control panel and since BRC1E63 and BRC2E61 cannot be stored inside the indoor unit, please place it separately.

New Adaptor for wiring (operation status output)

Example: Interlocking operation of the indoor unit and ventilation fan that takes in fresh air.

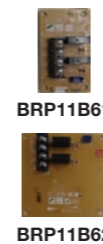

By installing it in the indoor unit with a simple wire connection, this adaptor takes out the operating signals for the indoor unit fan and the compressor and enables the interlocking of equipment such as the ventilation fan.

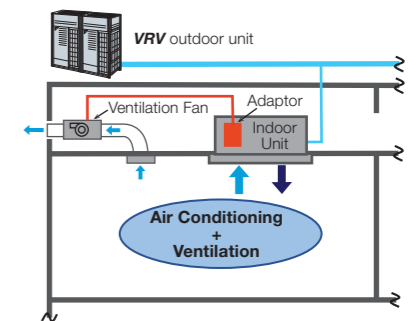

Control Systems

Operation Control System Optional Accessories

For residential indoor unit use

No.	Item	Type	FFQ-B	FDXS-C	FTXS-K(A)
1	Remote controller	Wired ^{Note 1}	BRC1E63	BRC944B2 ^{Note 2}	
		Wireless	BRC7E530W	- ^{Note 3}	
2	Wired remote controller cord	Length 3 m (shielded wire)	-	BRCW901A03	
		Length 8 m (shielded wire)	-	BRCW901A08	
3	Adaptor for wiring		^{Note 4} KRP1BA57	-	
4	Wiring adaptor for electrical appendices		^{Note 4} KRP4AA53	-	
5	Installation box for adaptor PCB		KRP1BA101	-	
6	Remote sensor (for indoor temperature)		BRC501A-1	-	
7	Wiring adaptor for time clock/remote controller (Normal open pulse contact/normal open contact) ^{Note 5}		-	KRP413BB1S	
8	Remote controller loss prevention chain		-	KKF917A4	KKF910A4
9	Interface adaptor for DIII-NET use		DTA112BA51	KRP928BB2S	

Note: 1. Wiring for wired remote controller should be obtained locally.
 2. 3 m (BRCW901A03) or 8 m (BRCW901A08) length wired remote controller cord is necessary.
 3. A wireless remote controller is a standard accessory for FDXS and FTXS models.
 4. Installation box for adaptor PCB (KRP1BA101) is necessary.
 5. Time clock and other devices should be obtained locally.

System Configuration

No.	Item	Type	Model No.	Function
1	Residential central remote controller		^{Note 2} DCS303A51	• Up to 16 groups of indoor units (128 units) can be easily controlled using the large LCD panel. ON/OFF, temperature settings and scheduling can be controlled individually for indoor units.
2	Interface adaptor for residential indoor units		KRP928BB2S	• Adaptors required to connect products other than those of the VRV System to the high-speed DIII-NET communication system adopted for the VRV System. * To use any of the above optional controllers, an appropriate adaptor must be installed on the product unit to be controlled.
3	Interface adaptor for SkyAir-series		^{Note 3} ★DTA112BA51	
4	Central control adaptor kit For UAT(Y)-K(A),FD-K		★DTA107A55	• Up to 1024 units can be centrally controlled in 64 different groups. • Wiring restrictions (max. length: 1,000m, total wiring length: 2,000m, max. number of branches: 16) apply to each adaptor.
5	Wiring adaptor for other air-conditioner		★DTA103A51	
6	DIII-NET Expander Adaptor		DTA109A51	• Demand control of individual or multiple systems. • Low noise option for individual or multiple systems. • When installing DTA109A51, DTA104A61 into outdoor units of 14 class or larger.
6-1	External control adaptor		DTA104A61	
6-2	Mounting plate		BKS26A	

Note: 1. Installation box for ★ adaptor must be obtained locally.
 2. For residential use only. Cannot be used with other centralised control equipment.
 3. No adaptor is required for some indoor units.

Building Management System

No.	Item				Model No.	Function
1	intelligent Touch Controller	Basic	Hardware	intelligent Touch Controller	DCS601C51	• Air-Conditioning management system that can be controlled by a compact all-in-one unit.
1-1		Option	Hardware	DIII-NET plus adaptor	DCS601A52	• Additional 64 groups (10 outdoor units) is possible.
1-2	Electrical box with earth terminal (4 blocks)				KJB411A	• Wall embedded switch box.
2	intelligent Touch Manager	Basic	Hardware	intelligent Touch Manager	DCM601A51	• Air-conditioning management system that can be controlled by touch screen.
2-1			Hardware	iTM plus adaptor	DCM601A52	• Additional 64 groups (10 outdoor units) is possible. Max. 7 iTM plus adaptors can be connected to intelligent Touch Manager.
2-2				iTM power proportional distribution	DCM002A51	• Power consumption of indoor units are calculated based on operation status of the indoor unit and outdoor unit power consumption measured by kWh metre.
2-3		Option	Software	iTM energy navigator	DCM008A51	• Building energy consumption is visualised. Wasted air-conditioning energy can be found out.
2-4				BACnet® client	DCM009A51	• BACnet® equipment can be managed by intelligent Touch Manager.
2-5				HTTP Interface	DCM007A51	• Interface for intelligent Touch Manager by HTTP
2-6				*1 SVM series	SVMMPR2	• VRV Smartphone Control System for residence
2-7					SVMPC2	• VRV Smartphone Remote Controller for building
2-8					*5 SVMPS1	• Tenant Billing System with PPD
2-9		VRV Smartphone Control System				SVMMPR1
2-10	VRV Tablet and Smartphone Controller				SVMPC1	*6 • VRV Tablet and Smartphone Controller for small size building or residence with DTA116A51.
2-11	Multi Site Management System by using SVMPC1				MSMPN1	• MSM can control all VRV units via SVM system on multi site.
2-12	Di unit				DEC101A51	• 8 pairs based on a pair of ON/OFF input and abnormality input.
2-13	Dio unit				DEC102A51	• 4 pairs based on a pair of ON/OFF input and abnormality input.
3	Communication interface			*2 Interface for use in BACnet®	DMS502B51	• Interface unit to allow communications between VRV and BMS. Operation and monitoring of air-conditioning systems through BACnet® communication.
3-1				Optional DIII board	DAM411B51	• Expansion kit, installed on DMS502B51, to provide 2 more DIII-NET communication ports. Not usable independently.
3-2				Optional Di board	DAM412B51	• Expansion kit, installed on DMS502B51, to provide 16 more wattmeter pulse input points. Not usable independently.
4				*3 Interface for use in LONWORKS®	DMS504B51	• Interface unit to allow communications between VRV and BMS. Operation and monitoring of air-conditioning systems through LonWorks® communication.
5				*8 Modbus® Communication Adaptor	DTA116A51	*7 • Use of the Modbus® protocol enables the connection of the VRV system with a variety of home automation systems from other manufacturers.
5-1				Mounting plate	BKS26A	• When installing DTA116A51 into outdoor units of 14 class or larger.
6	Contact/analogue signal			Unification adaptor for computerised control	★DCS302A52	• Interface between the central monitoring board and central control units.

Note: *1. HTTP interface (DCM007A51) is also required.
 *2. BACnet® is a registered trademark of American Society of Heating, Refrigerating and Air-Conditioning Engineers (ASHRAE).
 *3. LonWorks® is a trademark of Echelon Corporation registered in the United States and other countries.
 *4. Installation box for ★ adaptor must be obtained locally.
 *5. PPD option (DCM002A51) for iTM is also required.
 *6. Possible to connect at a maximum of 2 DTA116A51.
 *7. Modbus® is a registered trademark of Schneider Electric S.A.
 *8. Cannot apply for **VRV** R series.

Daikin Engineering Supports

VRV Design and Sales Proposal Assistance

Daikin provides engineering supports for **VRV** systems. It consists of design supports that can assist consultants and architects, as well as sales proposal supports for air conditioning engineers and dealers. We at Daikin provide the software, the simulation results, and drawing materials to support the business-information modeling (BIM) currently entering the mainstream in construction industries.



Design assistance

For consultants and architects

Combines energy efficiency and comfort

CFD simulation to optimise outdoor unit layouts

Design flexibility

Model selection

Drawing materials support

Sales proposals

For air conditioning engineers and dealers

Model selection



Model Selection Software

VRV Xpress

VRV Xpress is a flexible design software that optimises equipment selection. It can empower consultants and air conditioning engineers so they can fully enhance their equipment selections to design the most effective, optimum systems possible. The software also allows the choice of outdoor units based on peak loads rather than the sum of required capacities for each indoor unit. This fine-tuning feature reduces **VRV** system sizes and increases efficiency.



CFD Simulation to Optimise Outdoor Unit Layouts

DT FLOW II

DT FLOW II is a simulation software that uses computational fluid dynamics (CFD), aiming to optimise outdoor unit layouts right at the design stage. When discharged air from the outdoor unit is drawn back into the suction vent, it can short circuit the system and lead to: decrease in efficiency of cooling operations, capacity shortages, operation cut-offs, and shorter lifetime for the outdoor unit. To avoid the need for expensive layout modifications once construction is complete, Daikin uses the CFD method at the early design stage. This can help consultants and architects optimise their outdoor unit arrangement.

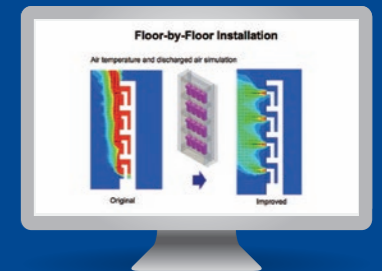

Drawing Supports

CAD Symbols

Users download CAD symbol drawing materials, including 2D CAD symbols and 3D Revit data, for **VRV** systems designing. The 3D Revit data contains specifications for Daikin products, including things like capacities and electric characteristics to support Business Information Modeling (BIM).

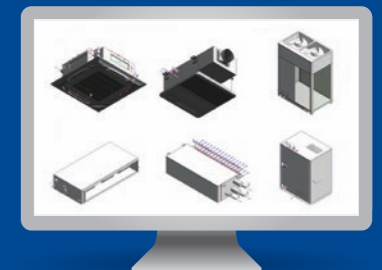



Warning



- Ask a qualified installer or contractor to install this product. Do not try to install the product yourself. Improper installation can result in water or refrigerant leakage, electrical shock, fire or explosion.
- Use only those parts and accessories supplied or specified by Daikin. Ask a qualified installer or contractor to install those parts and accessories. Use of unauthorised parts and accessories or improper installation of parts and accessories can result in water or refrigerant leakage, electrical shock, fire or explosion.
- Read the user's manual carefully before using this product. The user's manual provides important safety instructions and warnings. Be sure to follow these instructions and warnings.

If you have any enquiries, please contact your local importer, distributor and/or retailer.

Cautions on product corrosion

1. Air conditioners should not be installed in areas where corrosive gases, such as acid gas or alkaline gas, are produced.
2. If the outdoor unit is to be installed close to the sea shore, direct exposure to the sea breeze should be avoided. If you need to install the outdoor unit close to the sea shore, contact your local distributor.

VRV is a trademark of Daikin Industries, Ltd.

VRV Air Conditioning System is the world's first individual air conditioning system with variable refrigerant flow control and was commercialised by Daikin in 1982.

VRV is the trademark of Daikin Industries, Ltd., which is derived from the technology we call "variable refrigerant volume."